

Free Hand sketching

①.

RIGHT SIDE VIEW

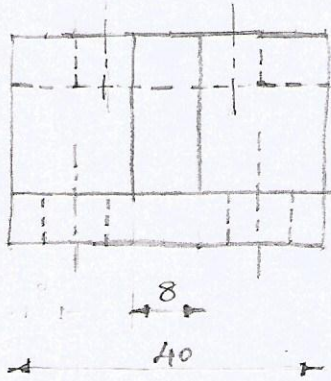

FRONT VIEW

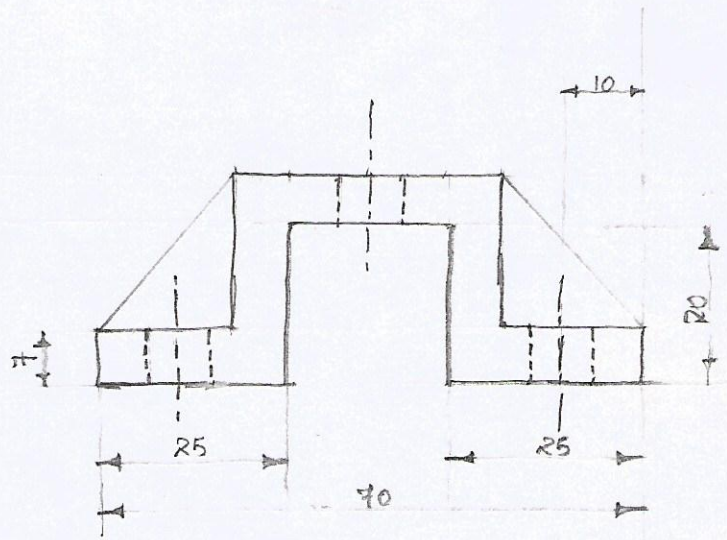

Top view R8

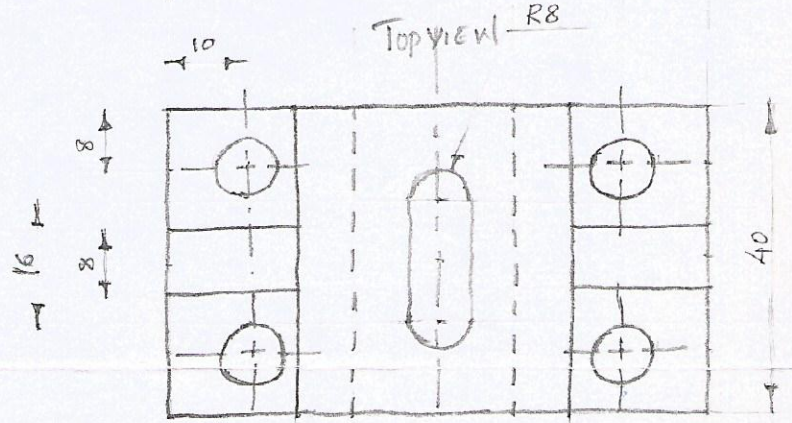

A free hand sketching is a drawing drawn by free hand without using drawing instruments. It is not drawn to scale, but should be in good proportion by eye judgment.

2

FRONT VIEW

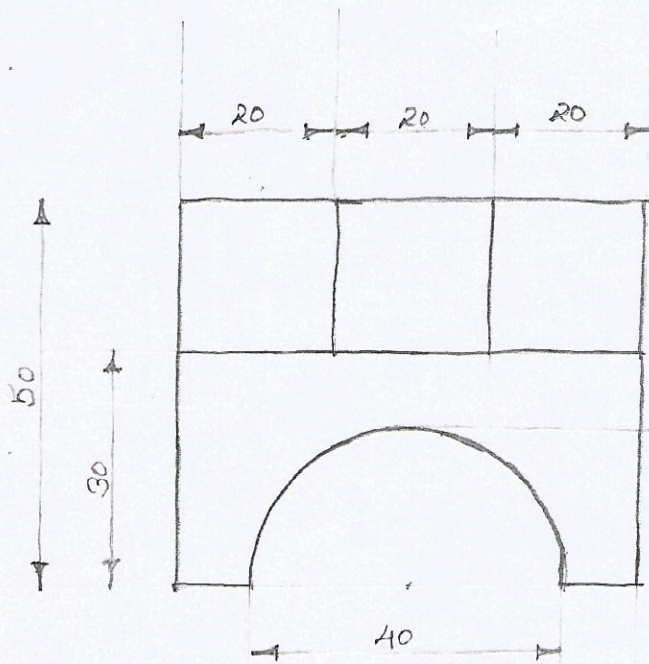

LEFT SIDE VIEW

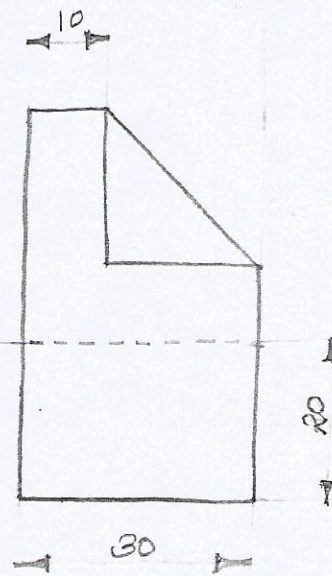

TOP VIEW

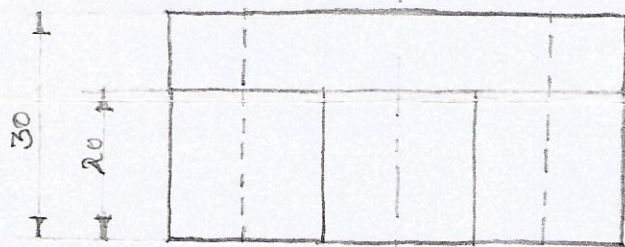

3

R212

FRONT VIEW

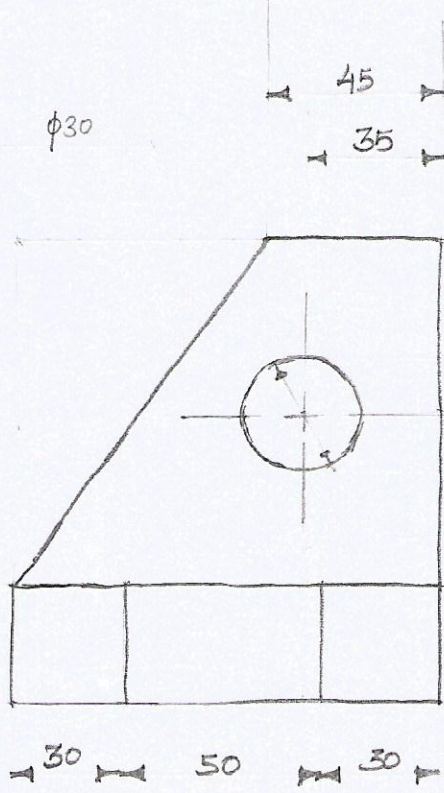

LEFT SIDE VIEW

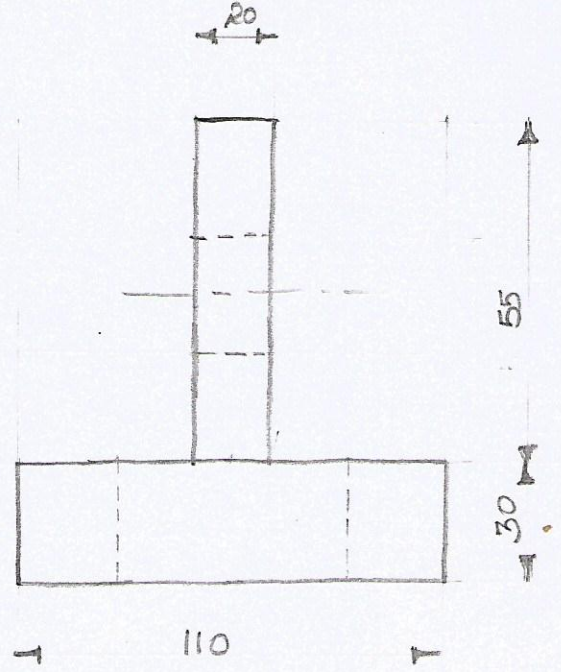

TOP VIEW

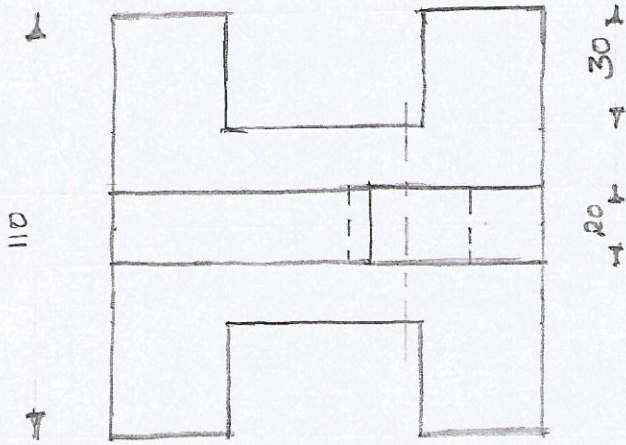

SCALE: 1:2

4

FRONT VIEW

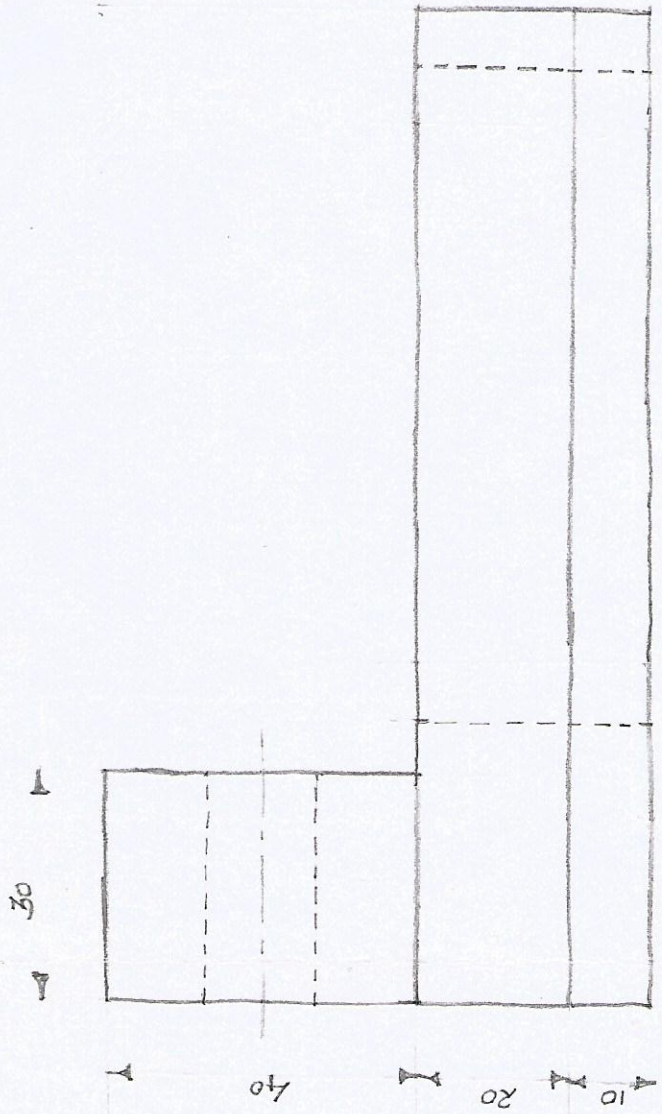

Top

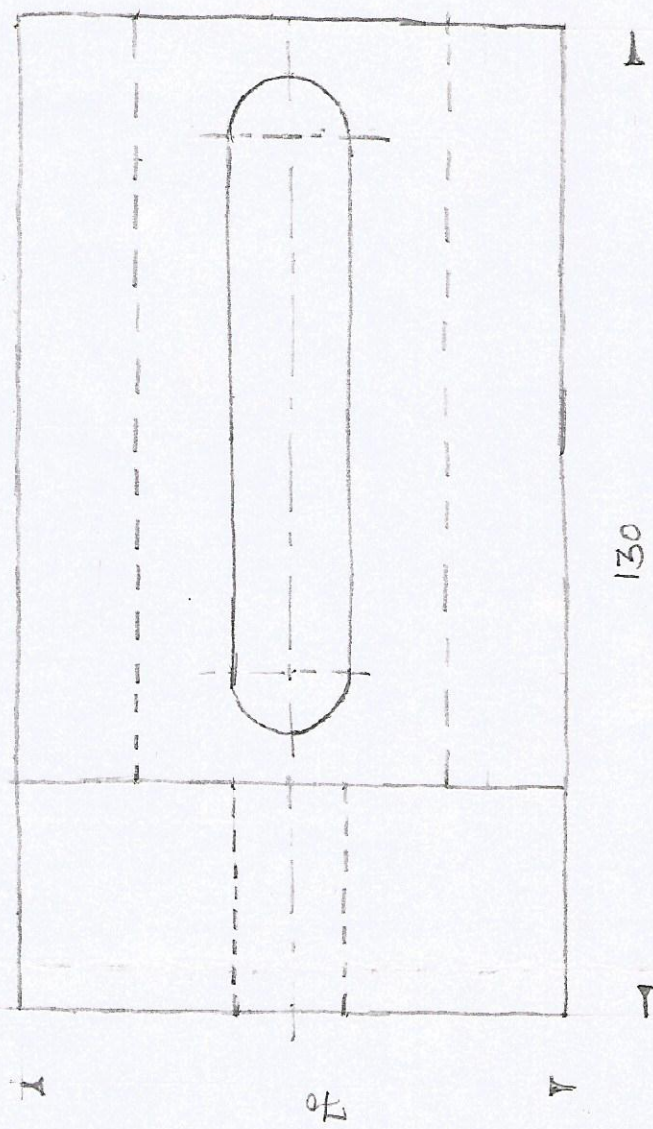

RIGHT SIDE VIEW

$\phi 14$

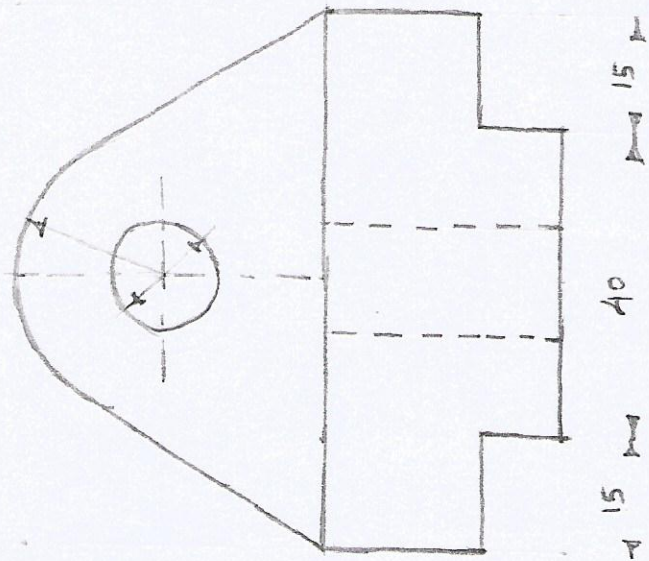

5

ELEVATION

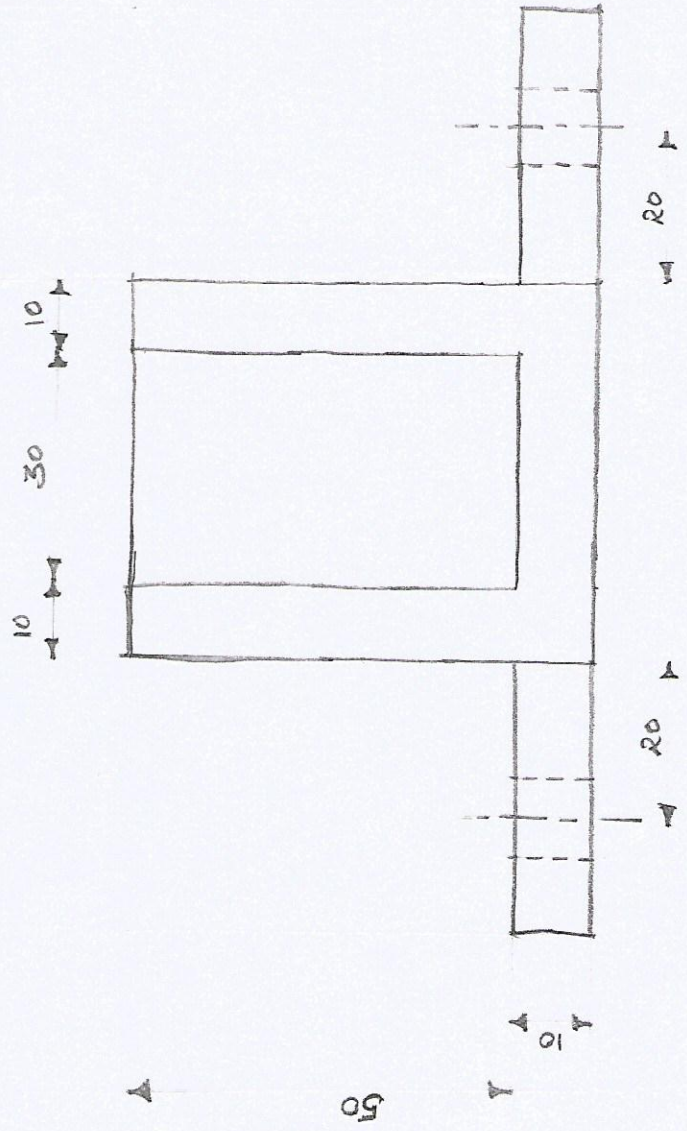

LEFT SIDE VIEW

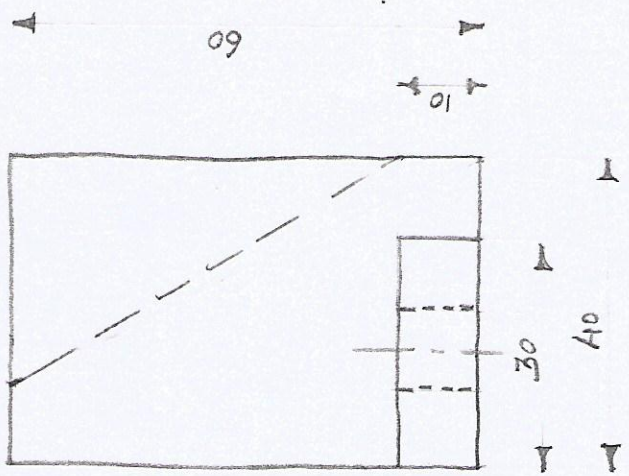

PLAN

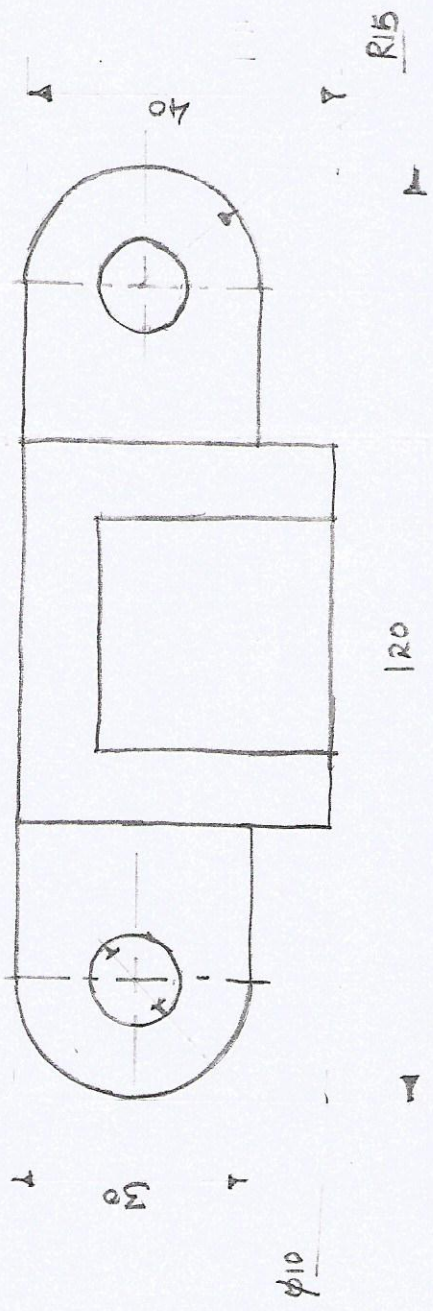

9

FRONT VIEW

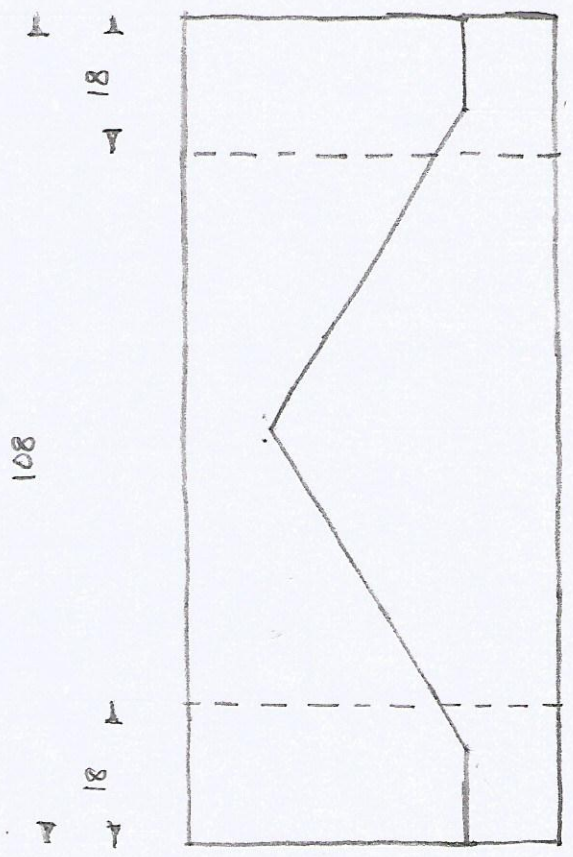

TOP VIEW

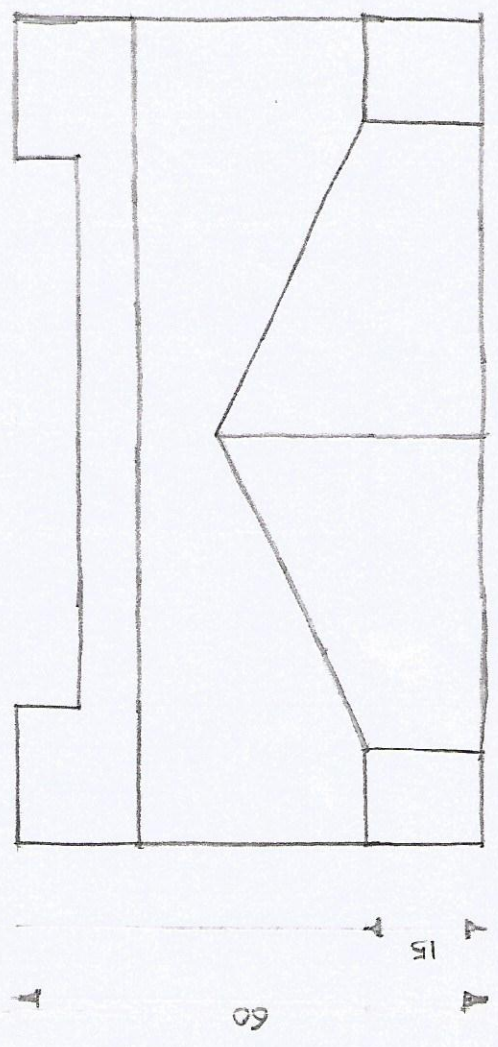

SIDE VIEW

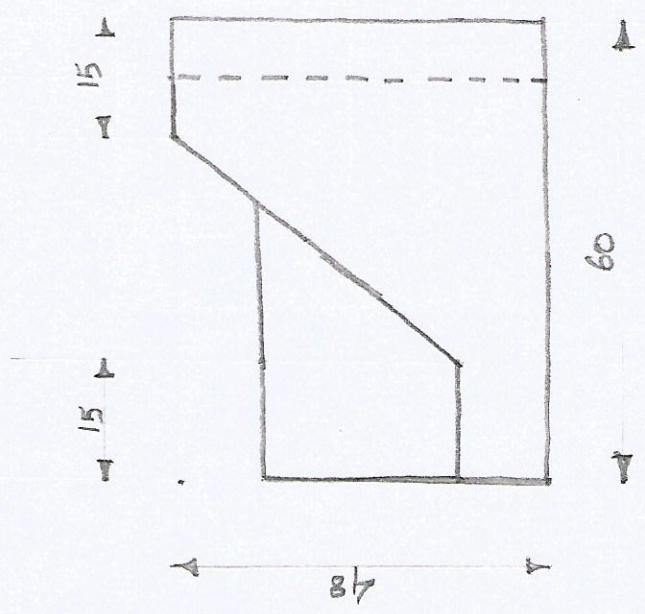

30°

4

FRONT

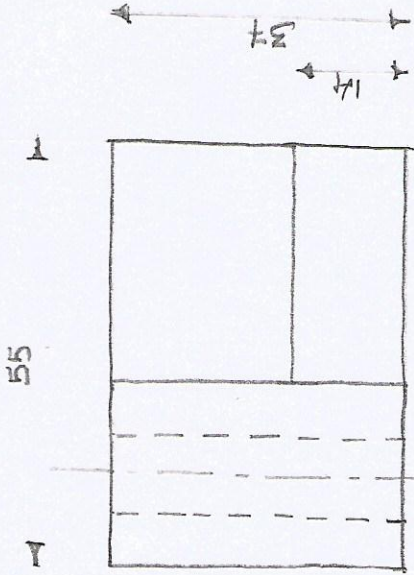

RIGHT SIDE

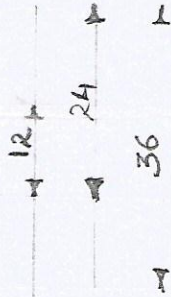
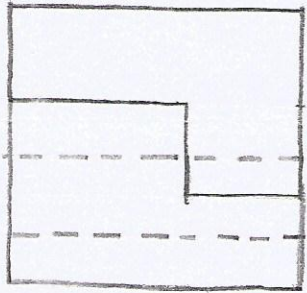

TOP

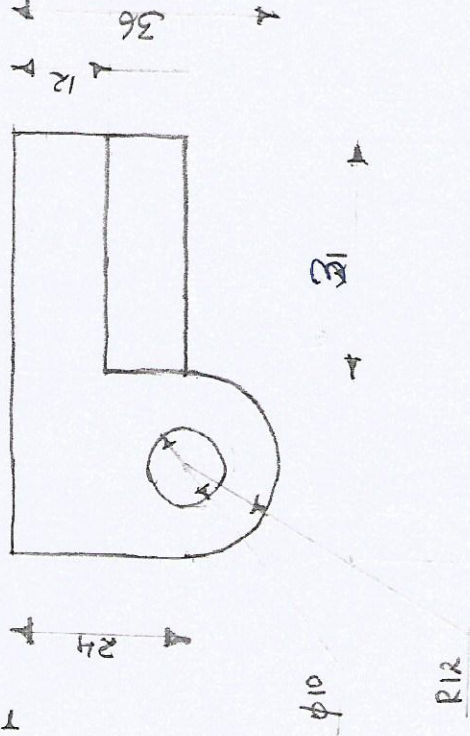

$\phi 10$

R12

8

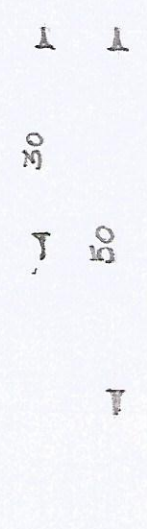
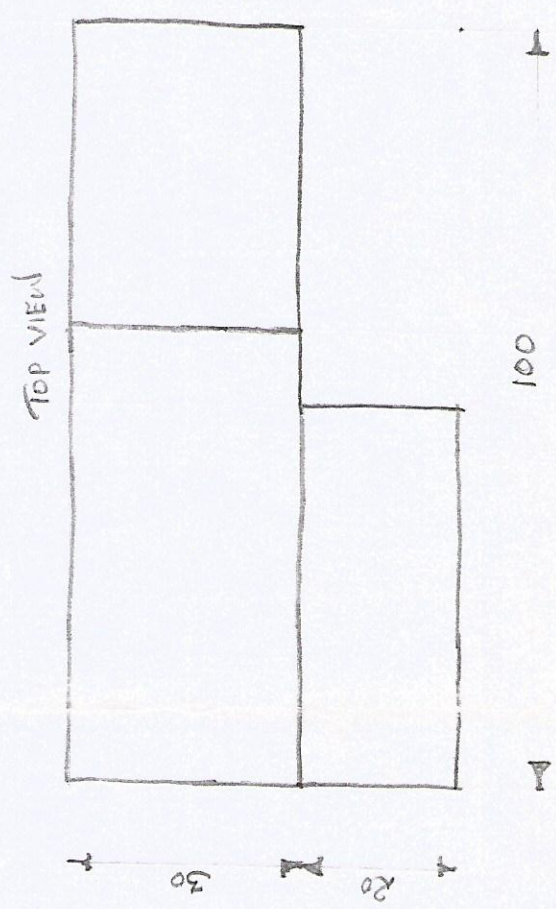
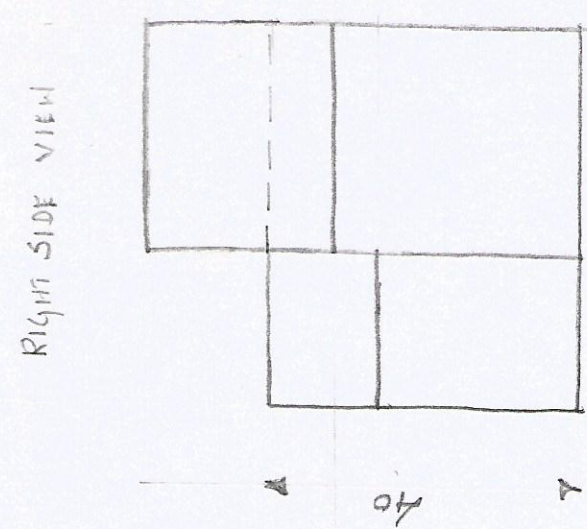
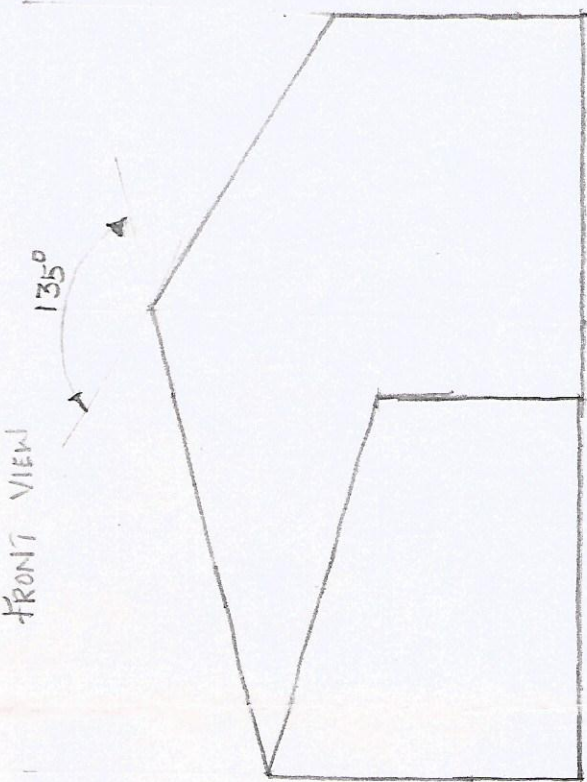

Cycloid

A cycloid is a curve generated by a point on the circumference of a circle as the circle rolls along a straight line. The rolling circle is called the generating circle and the line along which it rolls is called the directing line or base line.

Draw a cycloid given the diameter of the generating circle as 40 mm. And also draw the tangent and Normal of the curve at any point on it.

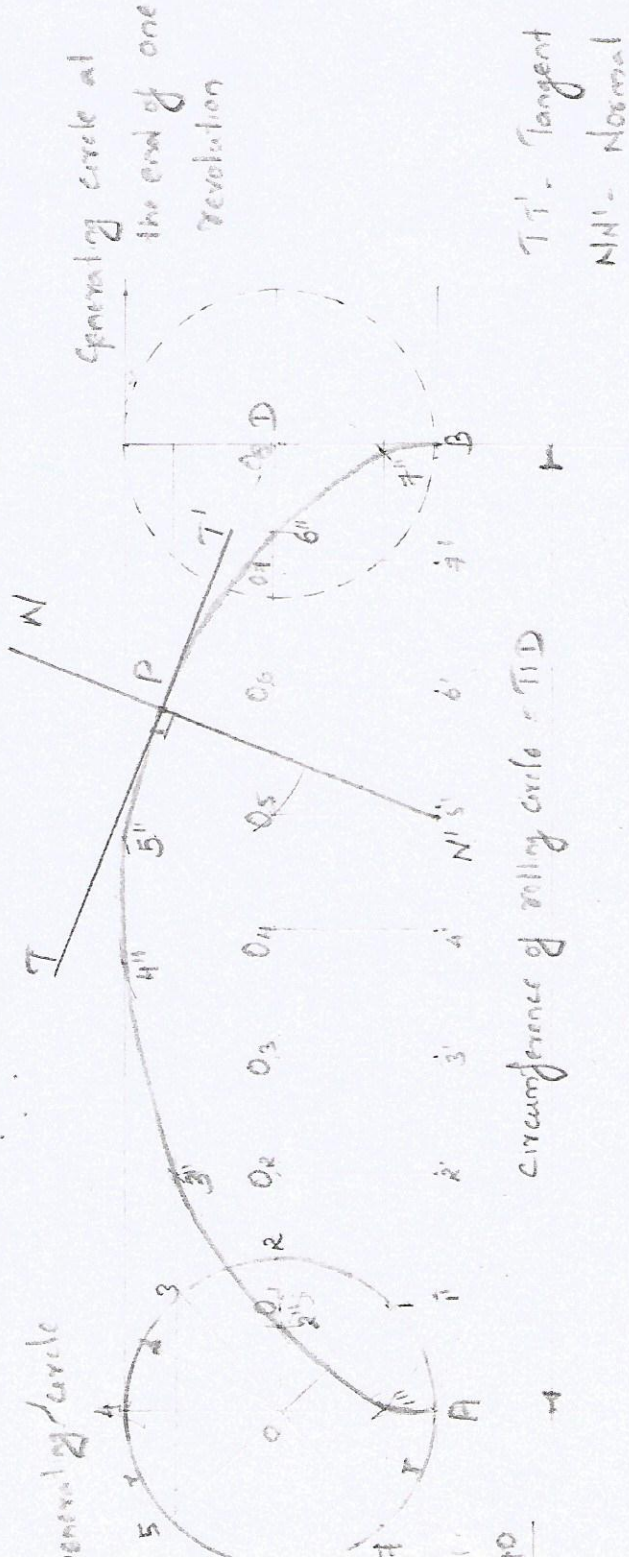

A circle of 50 mm diameter rolls along a straight line. A point P on the circumference of the circle is in contact with the straight line initially and the end of one revolution. Draw the cycloidal curve traced by the point P. Draw tangent & Normal to any point on the curve.

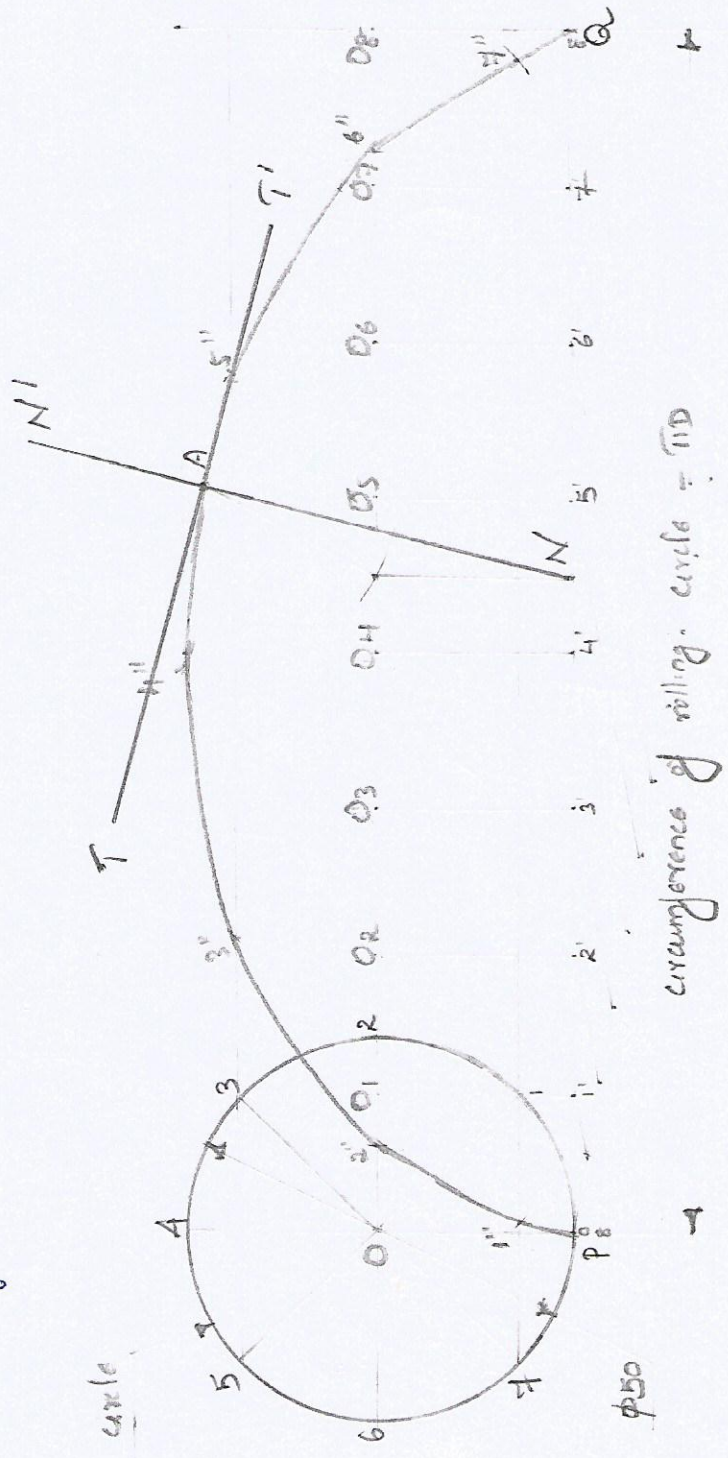

rolls along straight line without slip
Horizontal table

Rolls along straight line without slip
Horizontal table

Rolls along straight line without slip
Horizontal table

14

Involute
 An involute is a curve traced by a point on a string as it unwinds from around a circle or a polygon

Involute of a square

* Draw a square

* AB as radius B as centre draw an arc



* C as centre CE as radius

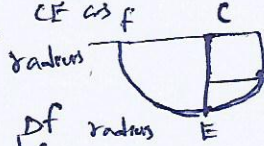

* D as centre Df as radius

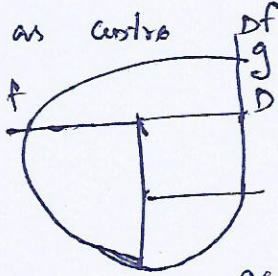

* A as centre Ag as radius.

Draw an Involute of a square of sides 20mm.

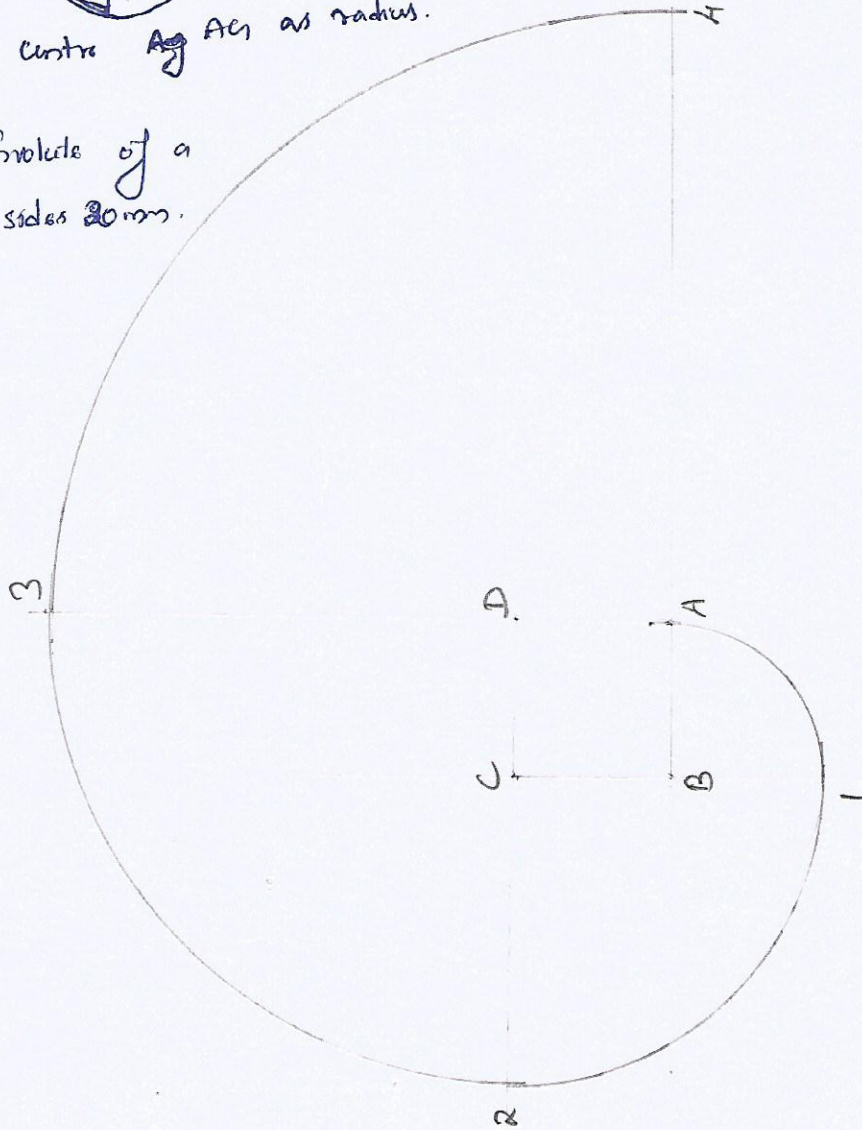

Side 25 mm

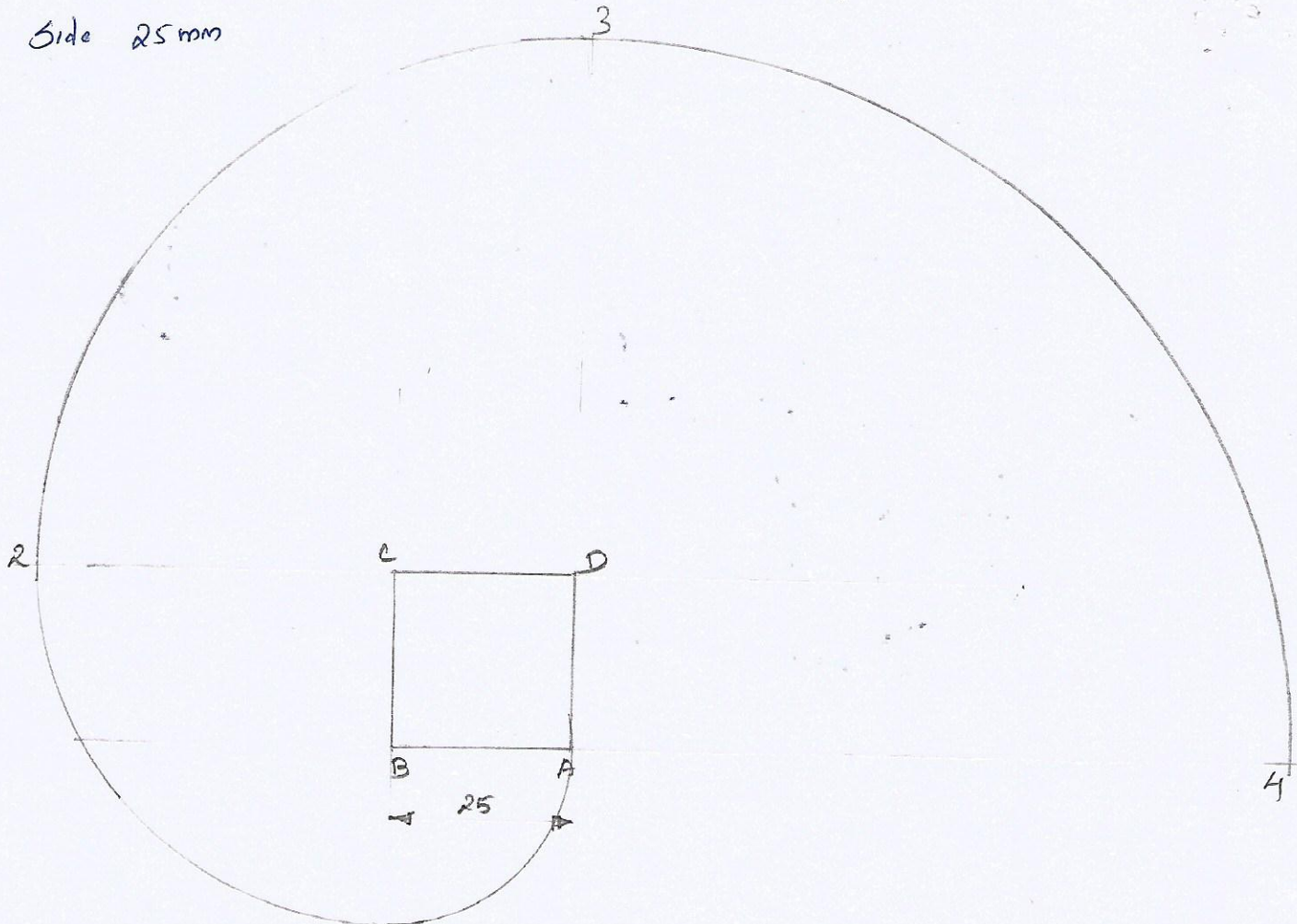

Draw an Involute of a triangle
of ^{base} Side 30 mm

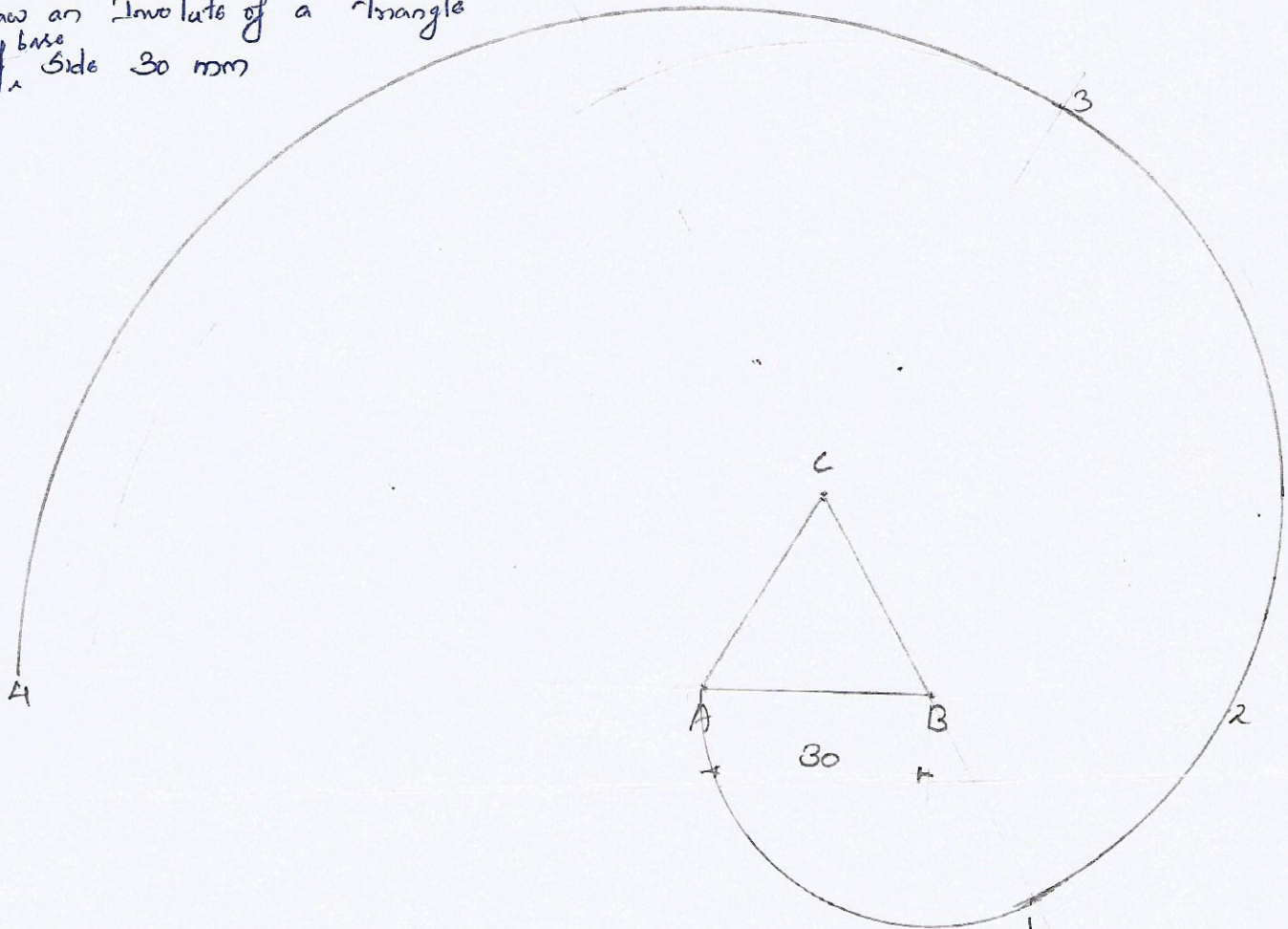

Draw an involute of a circle of diameter 40 mm

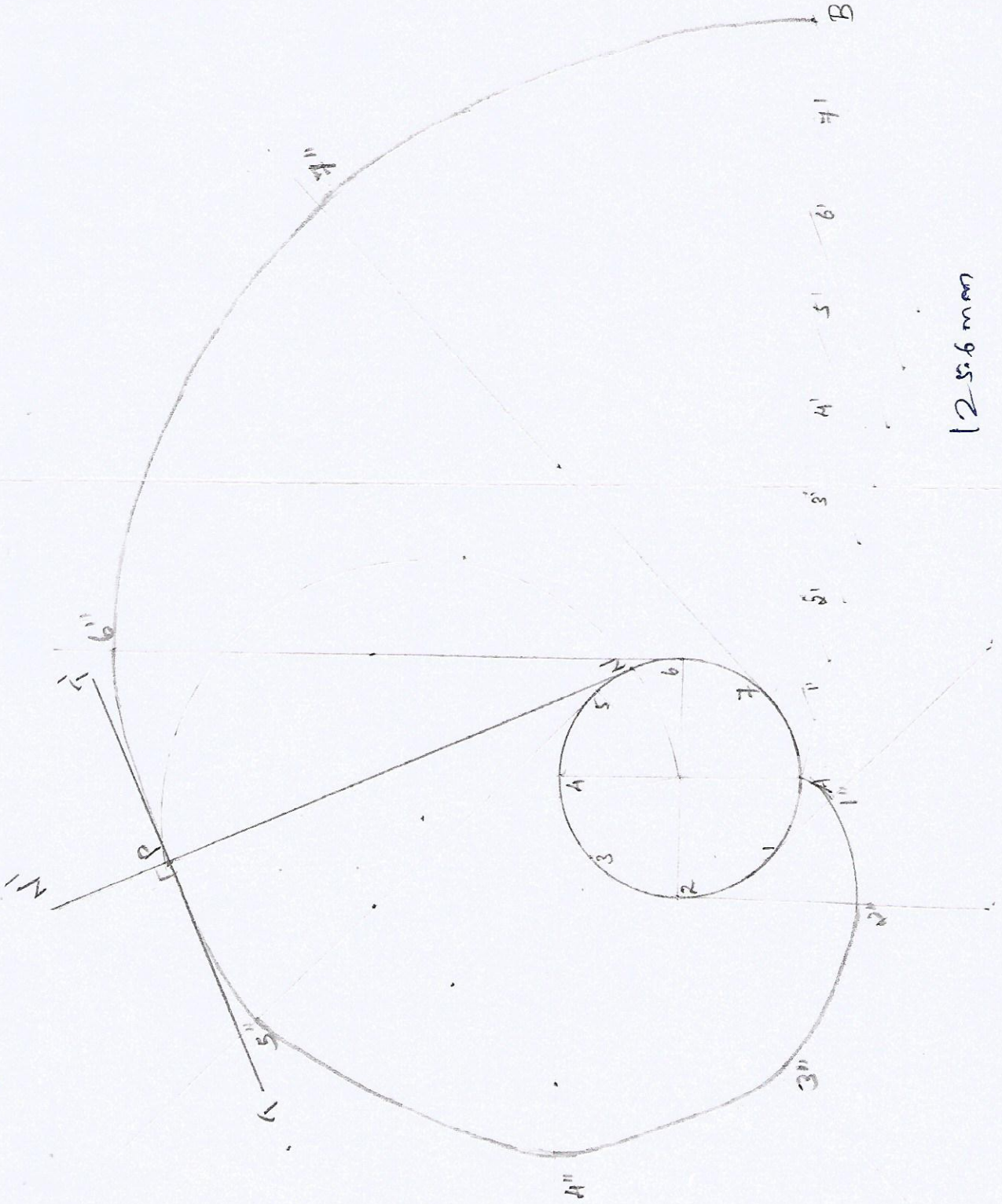

125.6 mm

An inelastic string of length 100 mm is wound around a circle of 26 mm diameter. Draw the path traced by the end of the string.

Also draw the tangent & Normal to the obtained curve at a point 80 mm away from the centre of the circle.

First Mark $UD = 8 \times 26 = 81.6$ mm

Divide 81.6 into 8 parts

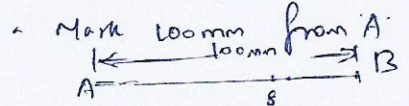
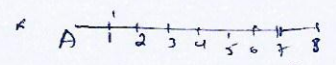

Divide 8 to B into two parts & mark 9 & 10

Draw the curve from point 'B'

Perimeter = 81.64 mm

$F \times 991$ ms

9th pen protractor

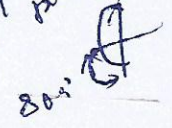

$$L = \frac{100 - 81.64}{2} = 18.26$$

$$L = 20$$

$$18.26 = 13 \times \theta$$

$$\theta = \frac{1.412}{20}$$

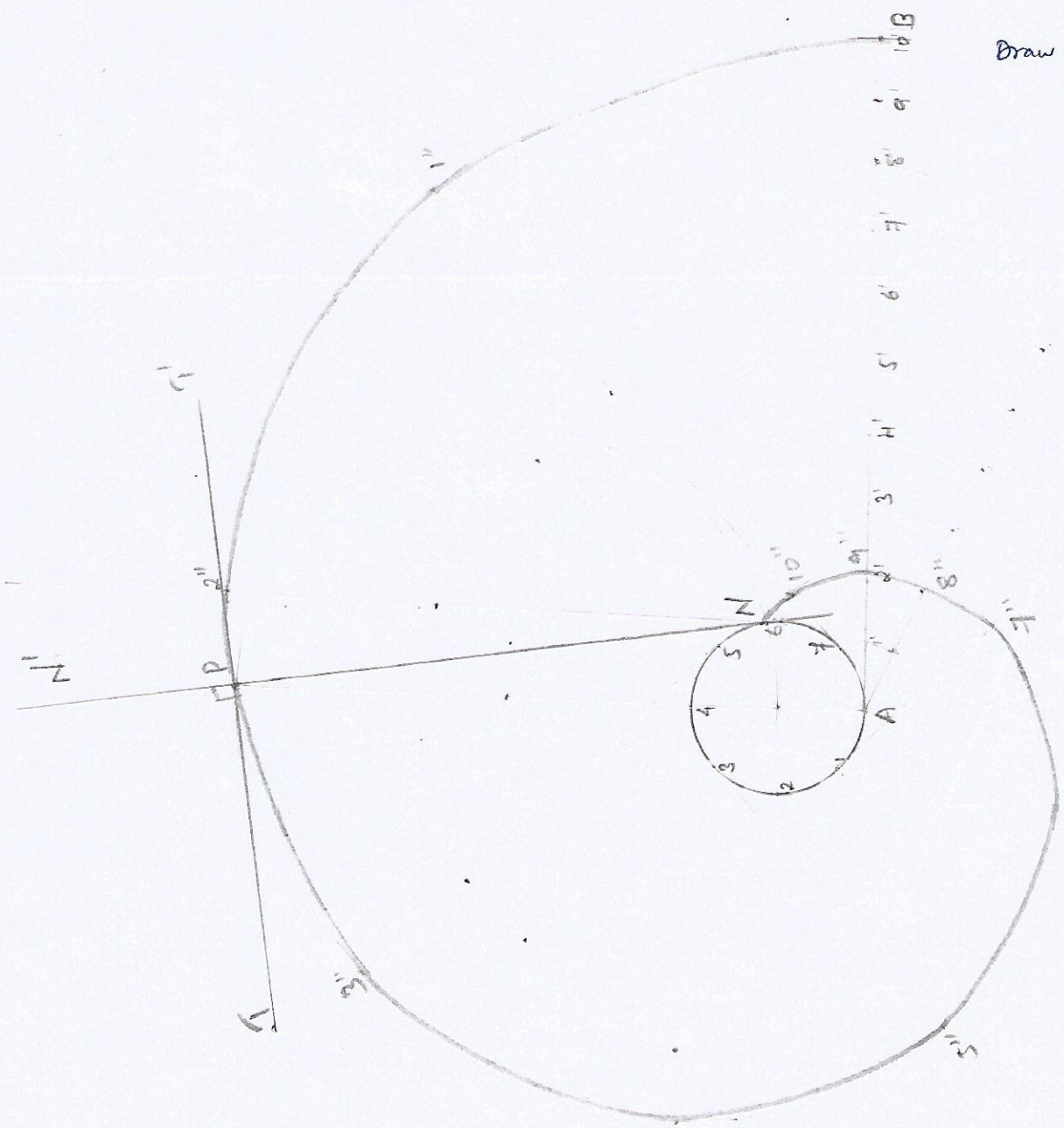

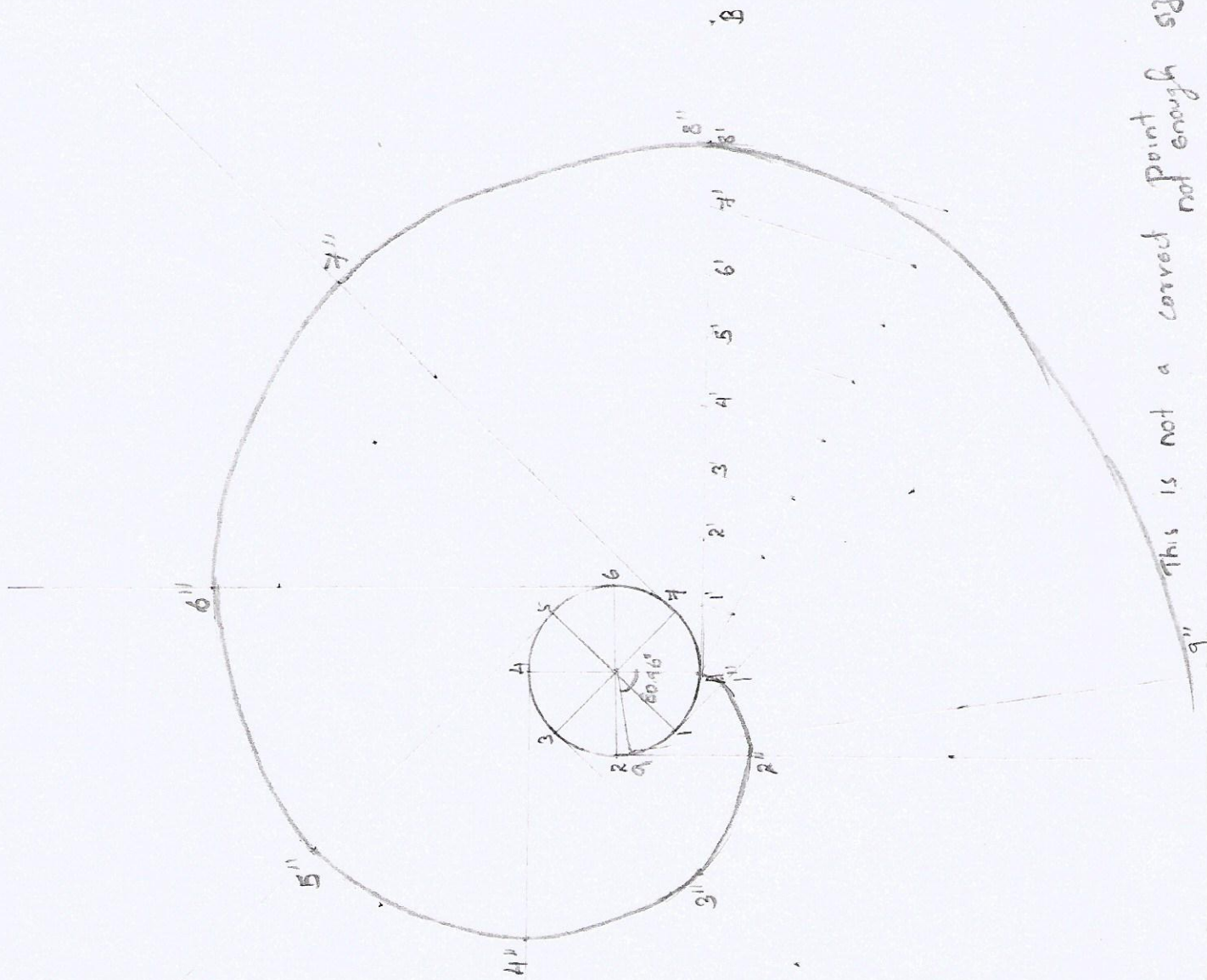

$$\text{Circumference} = \pi D$$

$$= \pi \times 26$$

$$= 81.64 \text{ mm}$$

$$L = r\theta$$

$$L = 100 - 81.64$$

$$= 18.36 \text{ mm}$$

$$18.36 = 13 \times \theta$$

$$\theta = 1.4123 \text{ rad} \times \frac{180}{\pi}$$

$$= \underline{\underline{80.96^\circ}}$$

This is not a correct point size (only paper)

Unit-II

Projection of Points, Lines and Plane surfaces

Projection of Points

Four Quadrants & Planes:

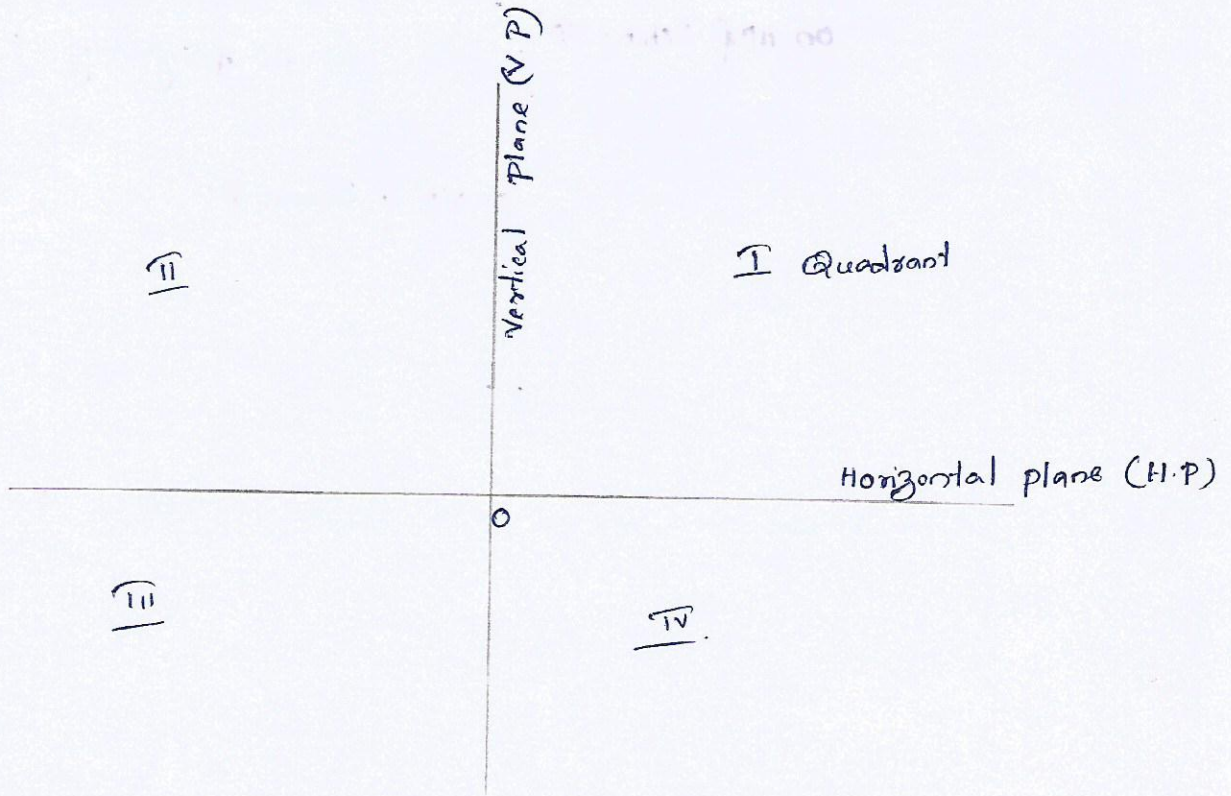

Position of Point in the four Quadrants:

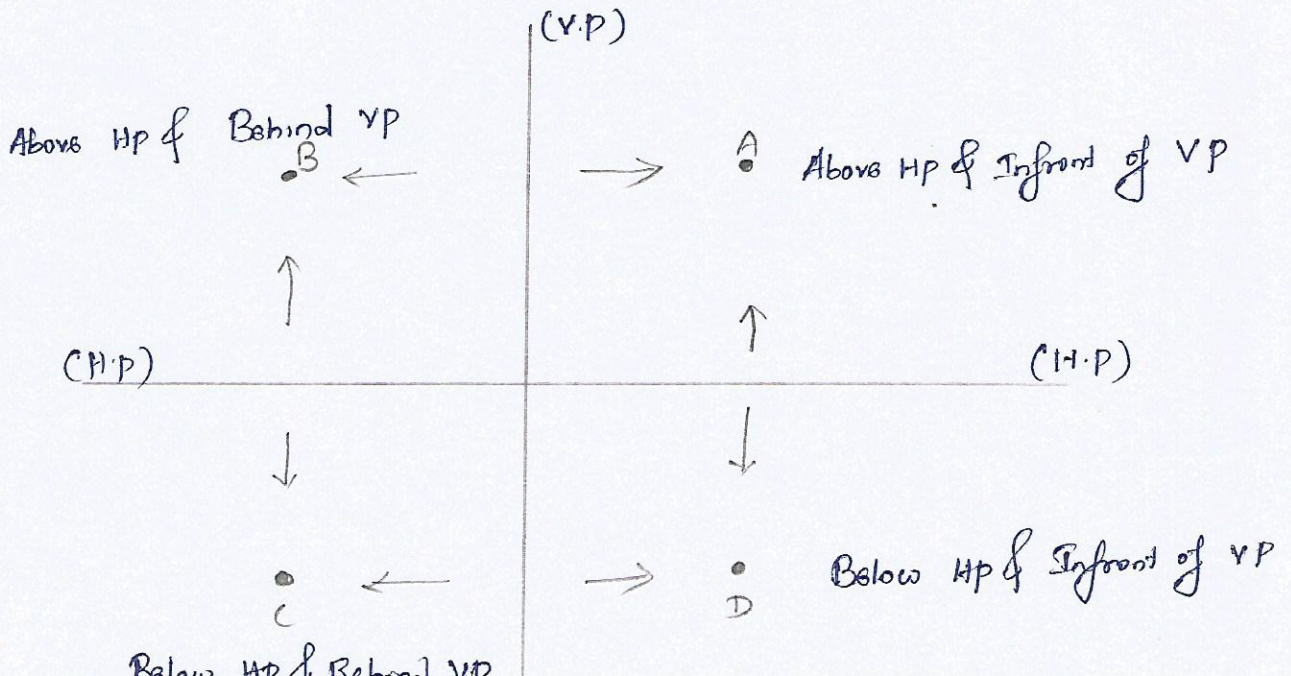

Position of Point on its Quadrants

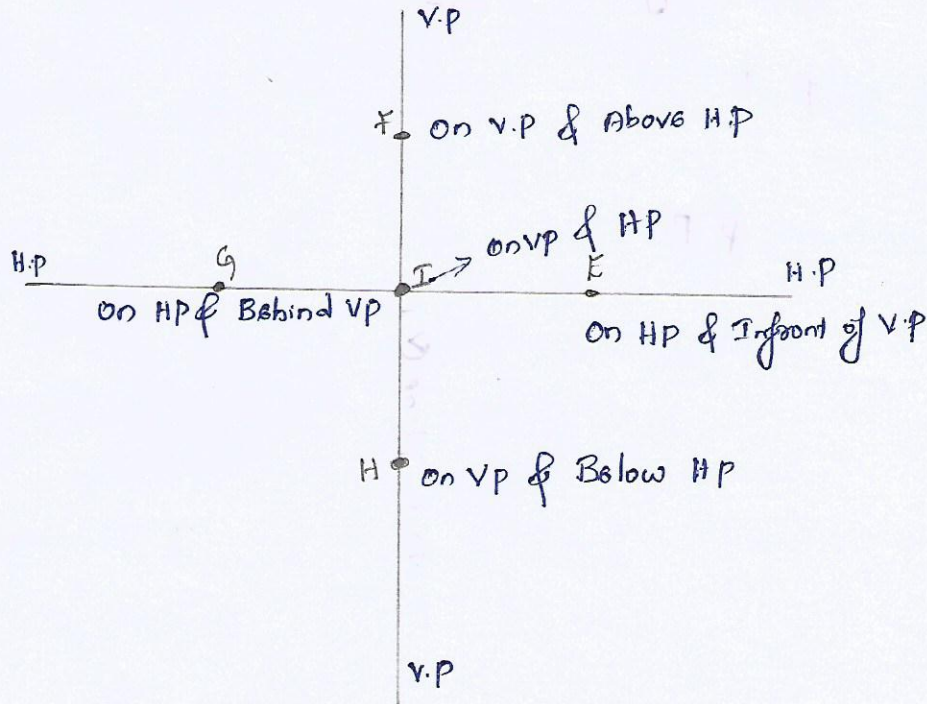

Draw the

A Point A is 20 mm above the H.P. and 40 mm in front of the V.P. Projection the point.

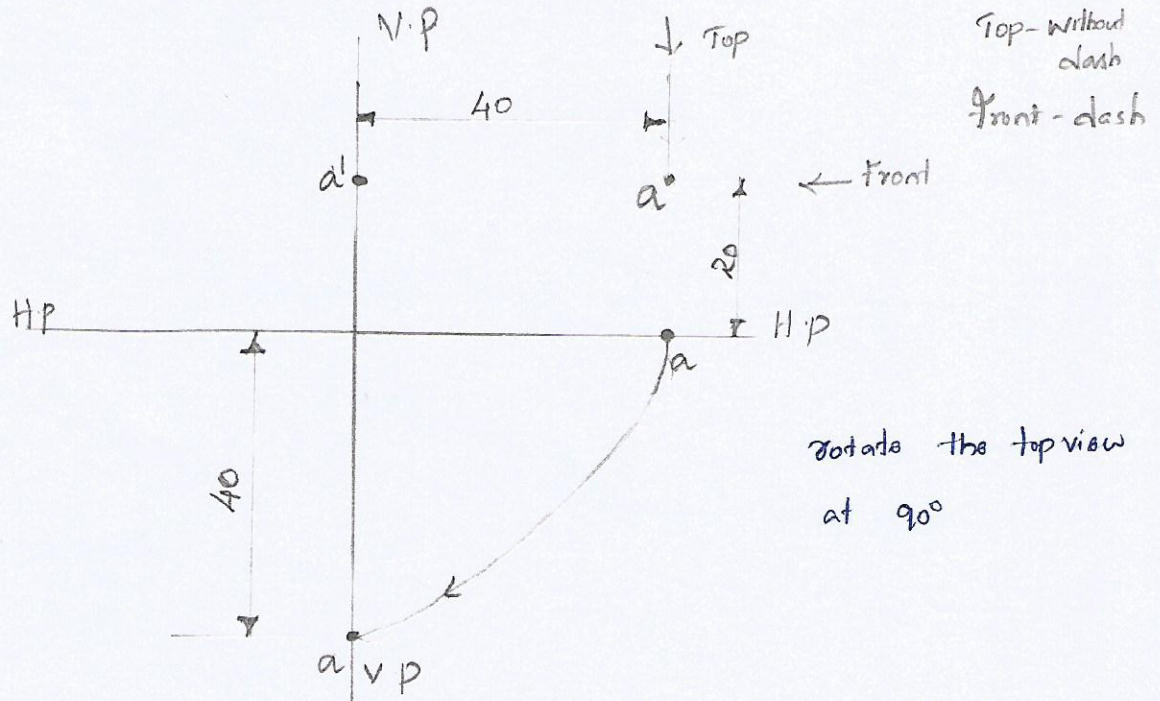

Rotate the top view at 90°

Short cut method:

HP refers \rightarrow front view

VP refers \rightarrow top view

front view should be marked with dash (a')

Top view should be marked without dash (a)

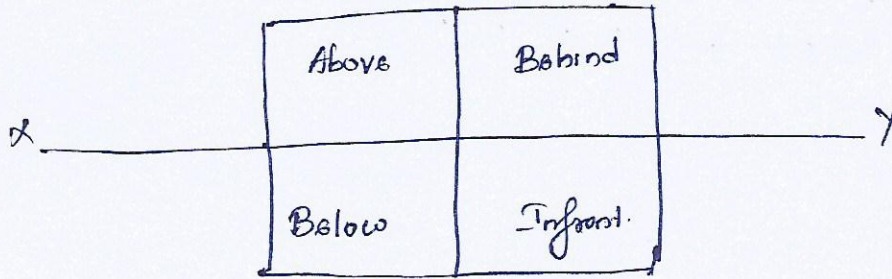

Top
↑
20mm above HP
front view with dash

40mm In front of VP
below
top view

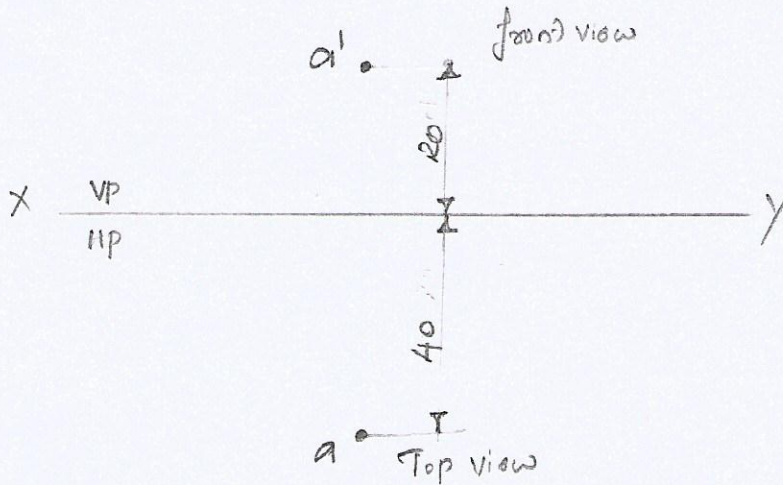

A point B is 50mm above the HP & 25mm behind the V.P. Project the Point.

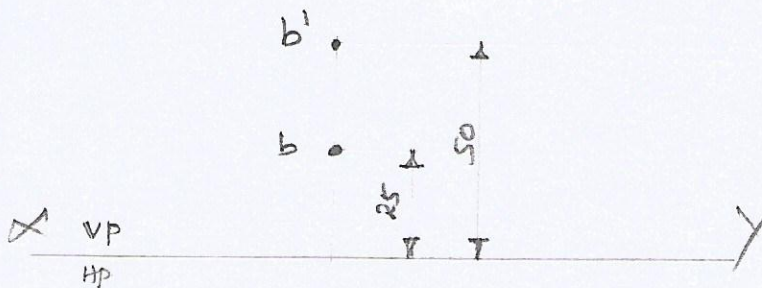

Mark the projection of the following points on a common reference line.

- i. P, 35 mm behind the V.P and 20 mm below H.P
- ii. Q, 40 mm in front of the V.P & 30 mm above the H.P
- iii. R, 50 mm behind the V.P & 15 mm above the H.P
- iv. S, 40 mm below the H.P & in the V.P.
- v. T, 30 mm in front of the V.P & 50 mm below the H.P
- vi. U, 35 mm behind the V.P & in the H.P.

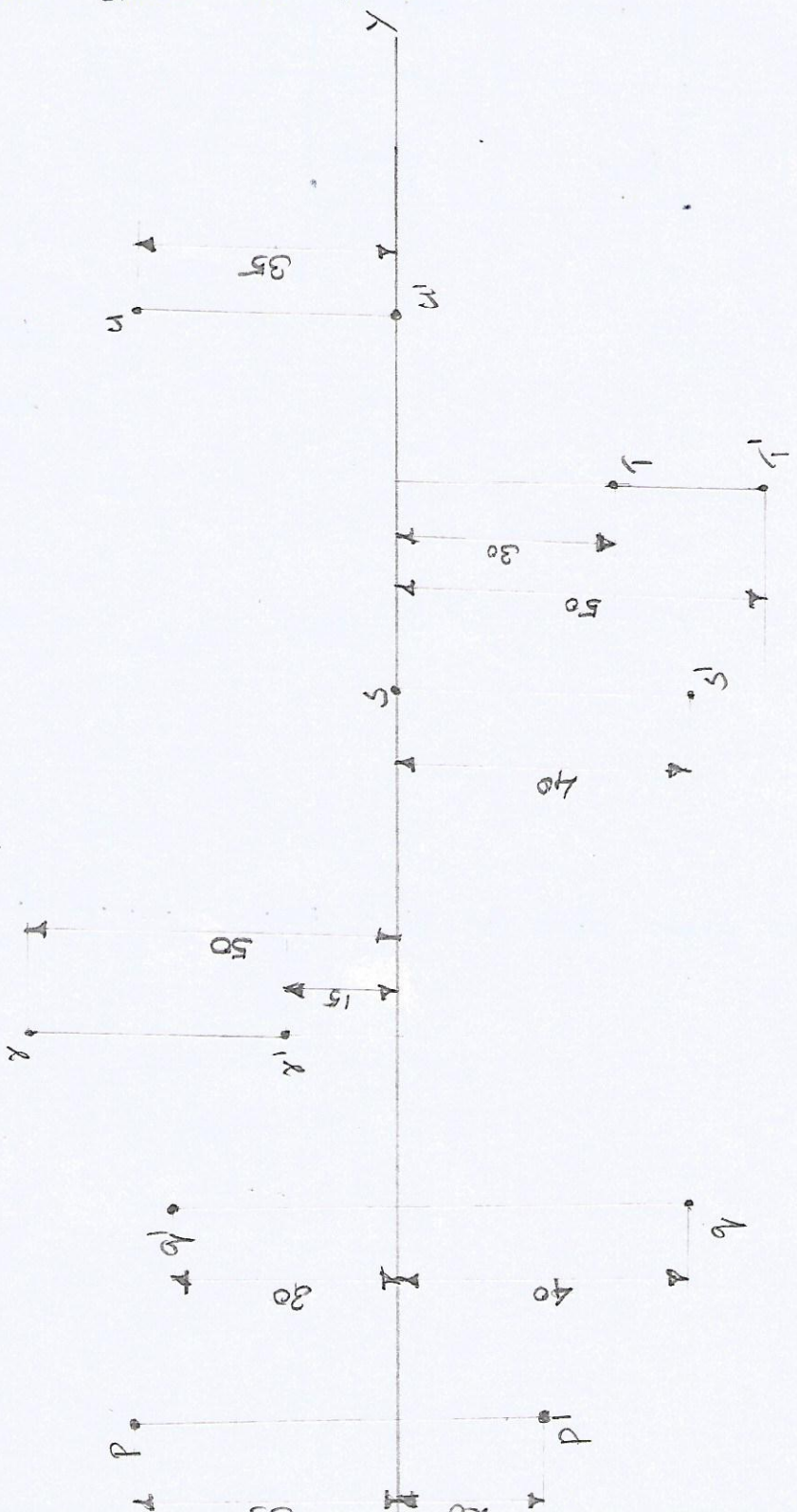

State Quadrant & specify the position of point for the following projections.

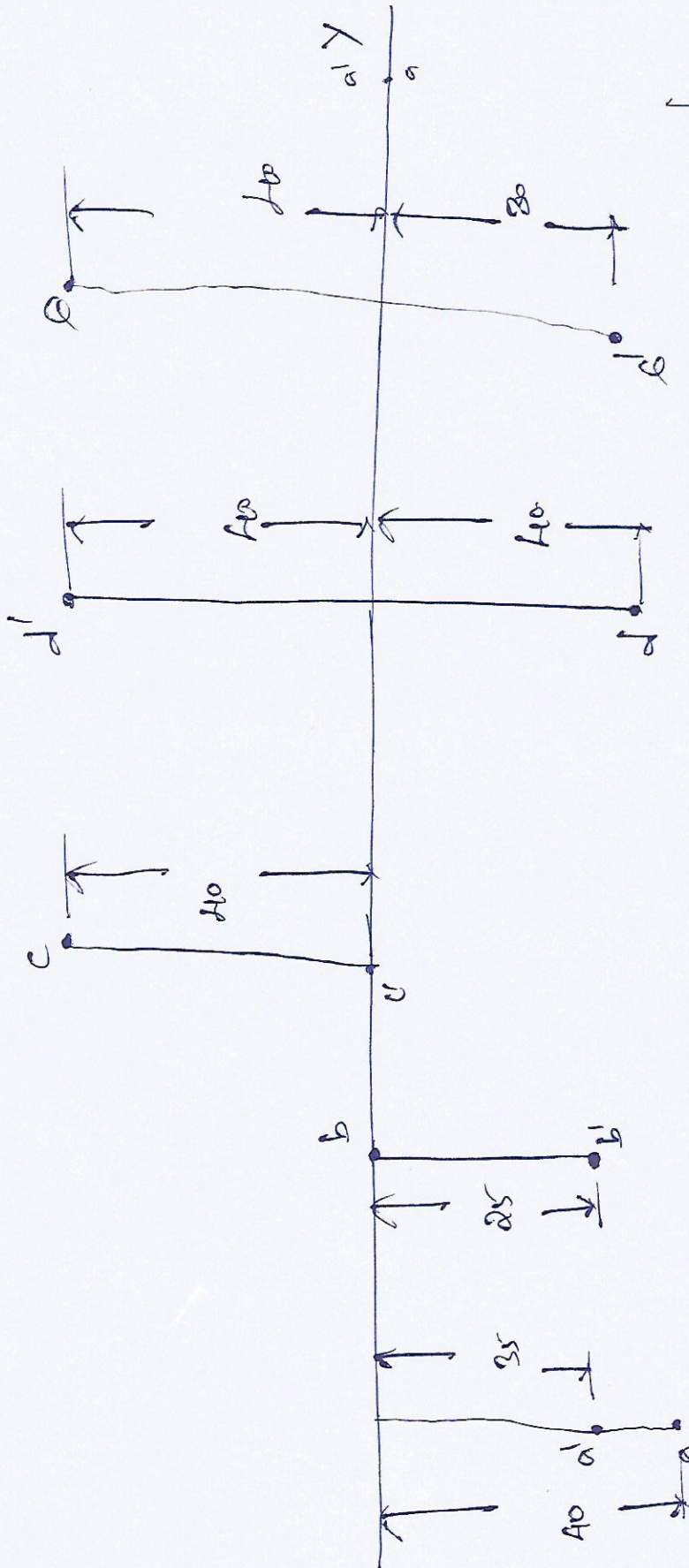

85mm below HP
 40mm above HP
 Ist Quadrant

On VP
 25mm below XY
 40mm above HP
 IInd & IVth

On the HP
 40mm behind VP
 IIIrd & Vth

40mm above HP
 30mm behind VP
 Ist & IInd

40mm behind VP
 30mm below HP
 IIIrd

On VP
 &
 On HP
 lies on the
 Intersection of
 both VP & HP

Projection of straight lines

A line joining any two points along the shortest route is called a straight line. Thus, the ends of a straight line are points.

Positions of a straight line:

1. Line Parallel to HP & VP.
2. Line Parallel to HP & Perpendicular to VP
3. Line Parallel to VP & \perp to HP
4. Line Parallel to HP & Inclined to VP
5. Line Parallel to VP & Inclined to HP
6. Line inclined to HP & lies on VP
7. Line inclined to VP & lies on HP.
8. Line inclined to both VP & HP.

1. Line Parallel to HP & VP

A line AB 50 mm long is placed parallel to both HP & VP. One end of the line A is 20 mm above HP and 25 mm in front of VP.

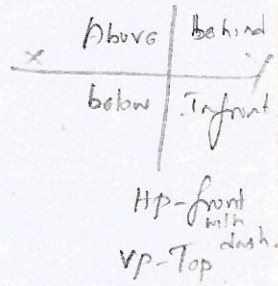
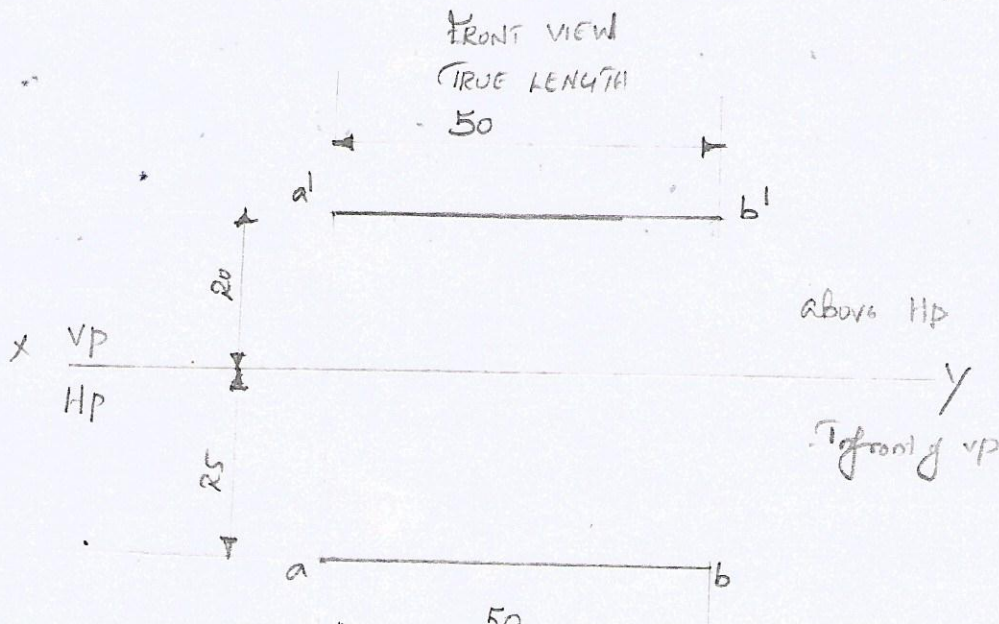
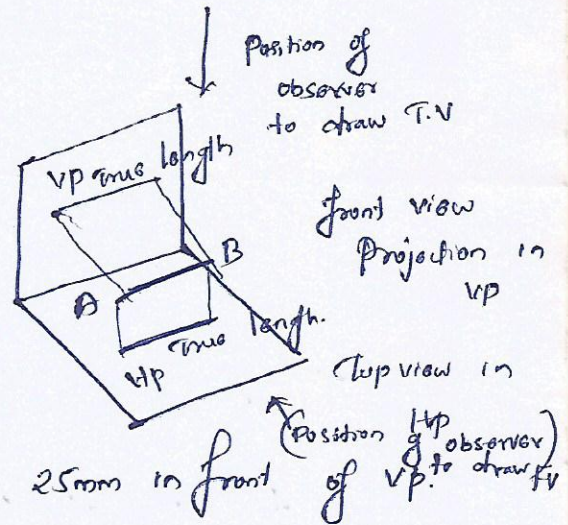

2. Line parallel to HP & \perp to VP:

A line AB 50mm long is parallel to HP & \perp to VP. One end A of the line is 15mm in front of VP & 20mm above HP. Draw its projections.

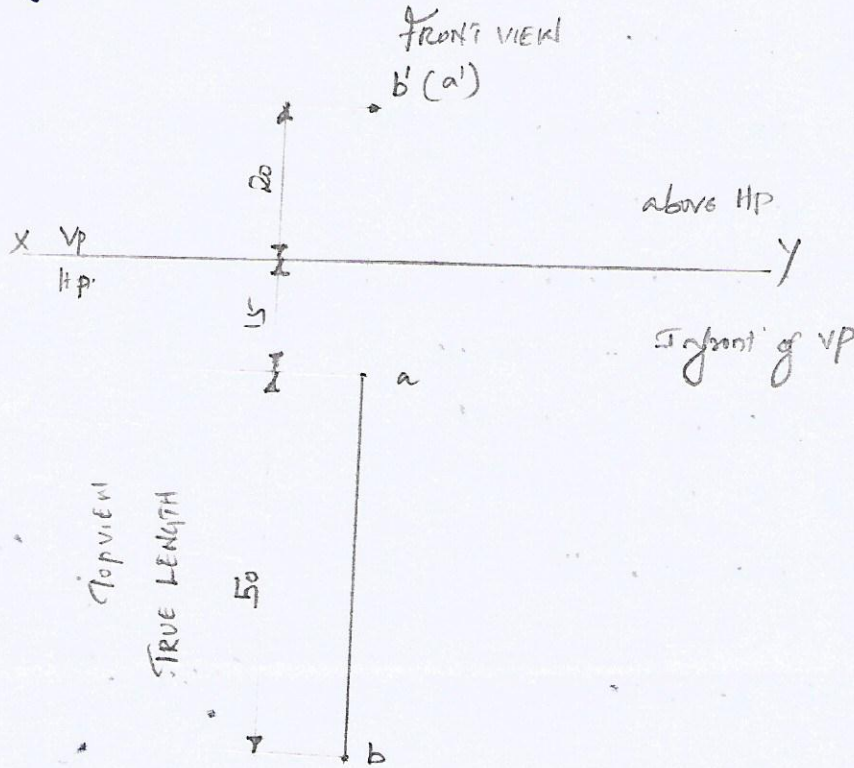
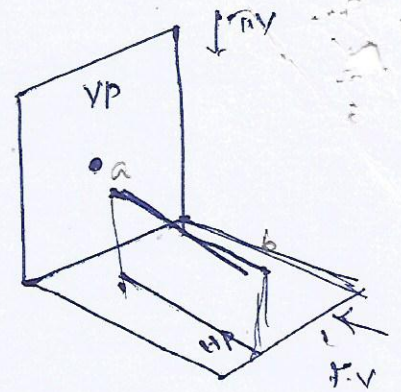

3. Line parallel to VP & \perp to HP:

A line AB 50mm long is parallel to VP and \perp to HP. The line is 15mm above the HP and 20mm in front of VP. The end B is nearer to HP. Draw its projections.

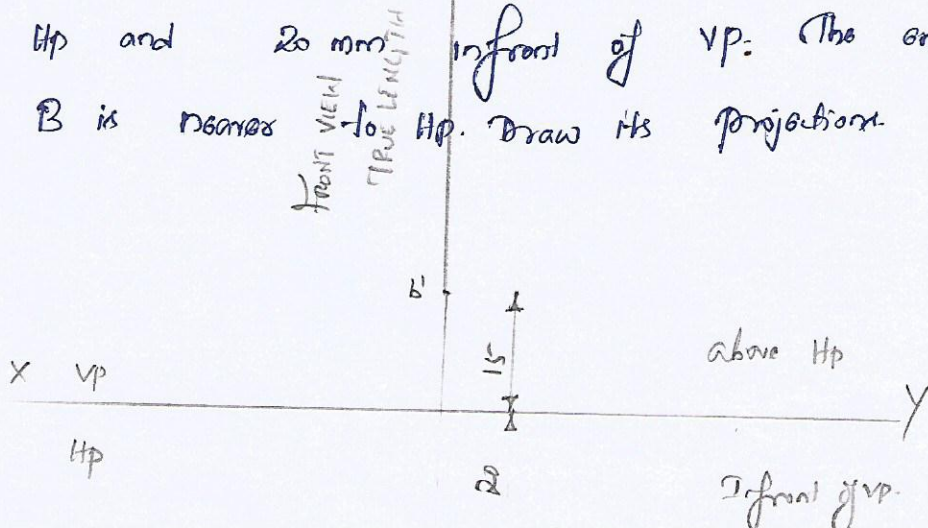
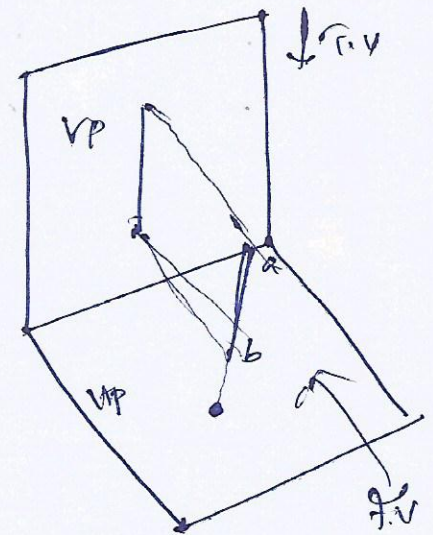

4. Line parallel to HP & inclined to VP:

A line AB 60 mm long is parallel to HP and inclined 40° to VP. The point A is 15 mm above HP & 20 mm in front of VP.

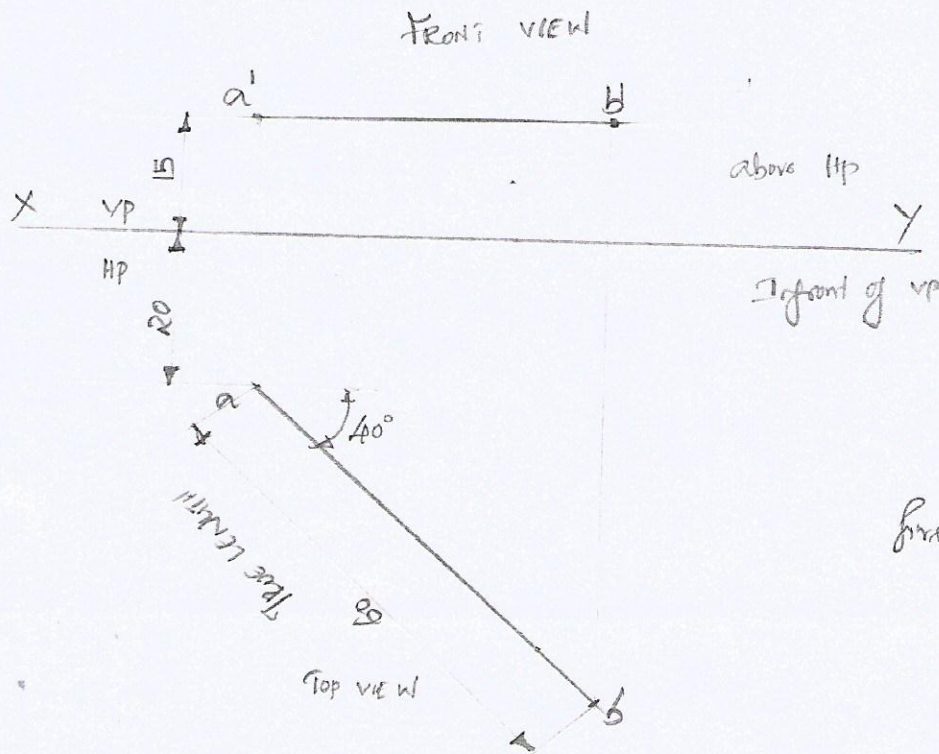
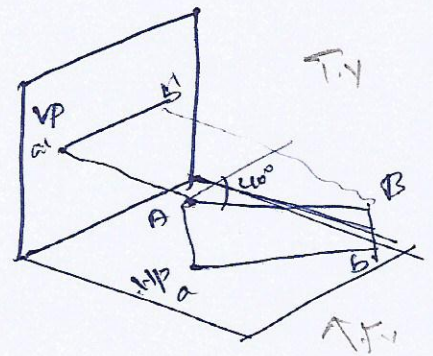

5. Line parallel to VP & inclined to HP:

A line AB 60 mm long is parallel to VP & inclined 60° to HP. The end A is 15 mm above HP & 45 mm in front of VP. Draw its projections.

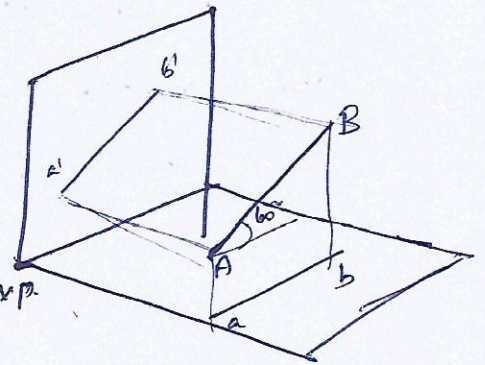

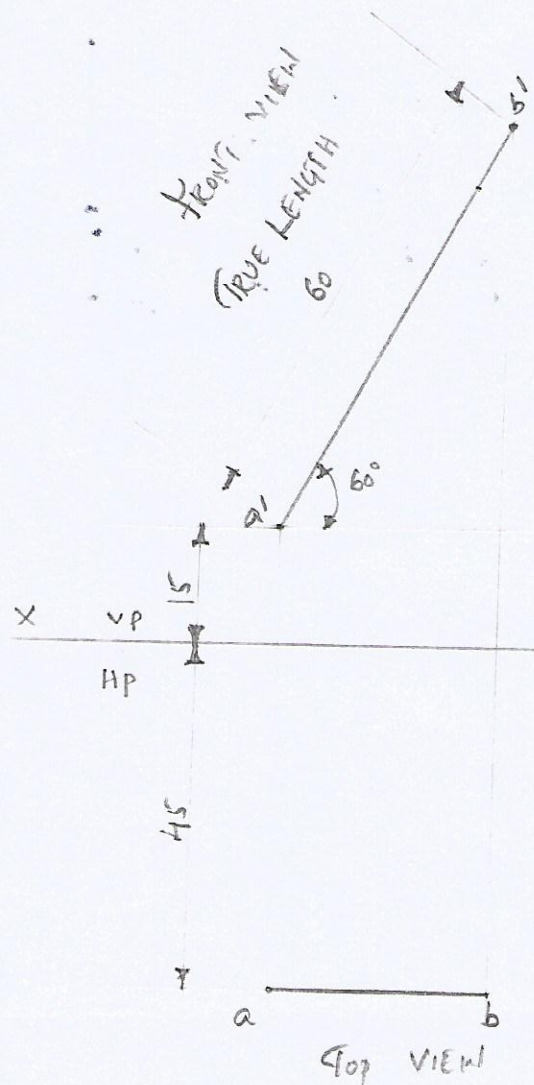

|| to VP
Inclined to HP

take angle
from VP

first draw the
Inclined line

above HP

In front of VP

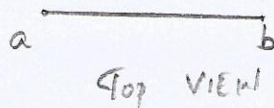

6. Line inclined to HP and lies on VP:

A line AB 60mm long is lying on VP and inclined at 60° to HP. The end A is 15 mm above HP. Draw its projections.

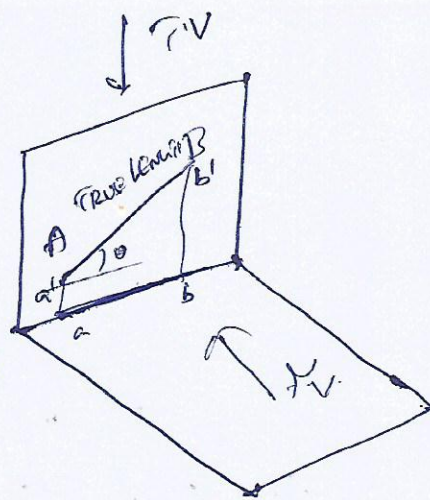

FRONT VIEW
TRUE LENGTH
60



Inclined to HP
angle from VP

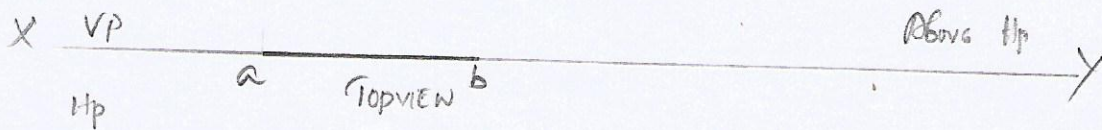

7. Line inclined to VP & lies on HP:

A line AB 60 mm long is lying on HP and inclined at 40° to VP. The end A is 20 mm in front of VP. Draw its projections.

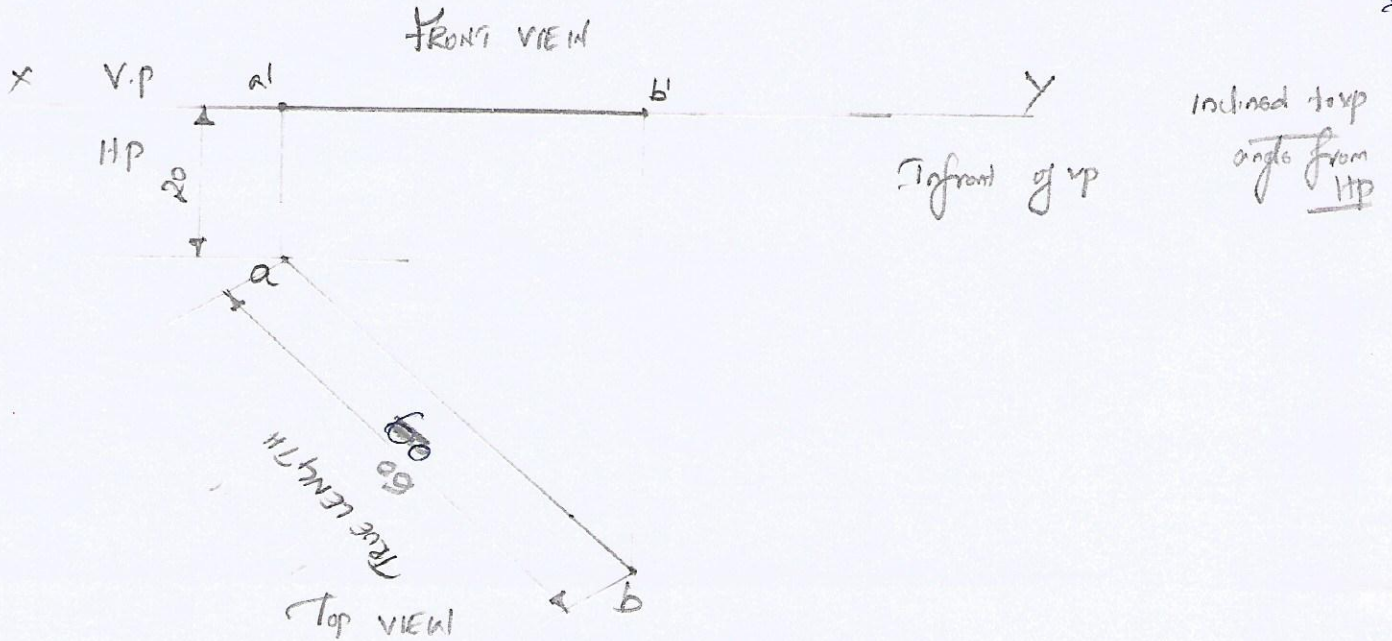
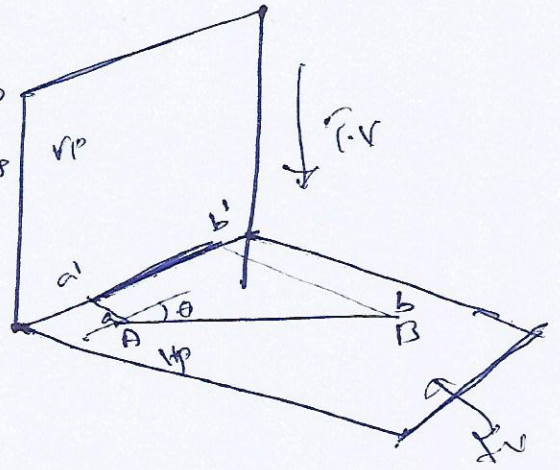

8. Line inclined to both VP & HP:

Inclined to VP

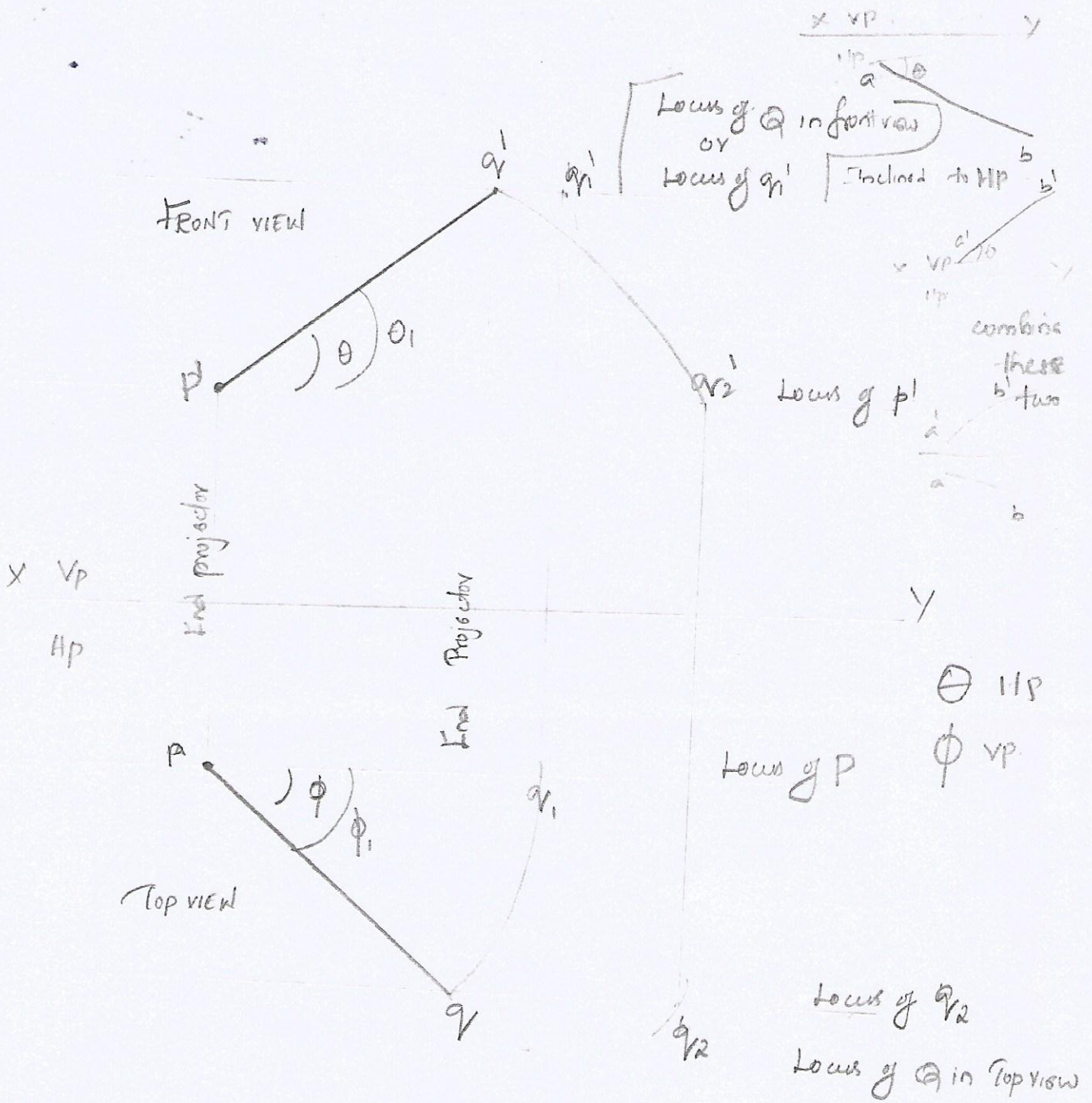

$P'q_1, Pq_2 \rightarrow$ True length

$P'q'$ \rightarrow front view

$Pq \rightarrow$ Top view

$\theta \rightarrow$ Angle of inclination with HP

$\phi \rightarrow$ " " with VP.

1. One end P of a line Pa, 55mm long is 35mm in front of the VP and 25mm above the HP. The line is inclined at 40° to the HP and 30° to the VP. Draw the Projections of Pa.

Given: True length Pa = 55mm
 End P 35mm in front of VP
 25mm above HP
 Inclination with HP = 40°
 " With VP = 30°

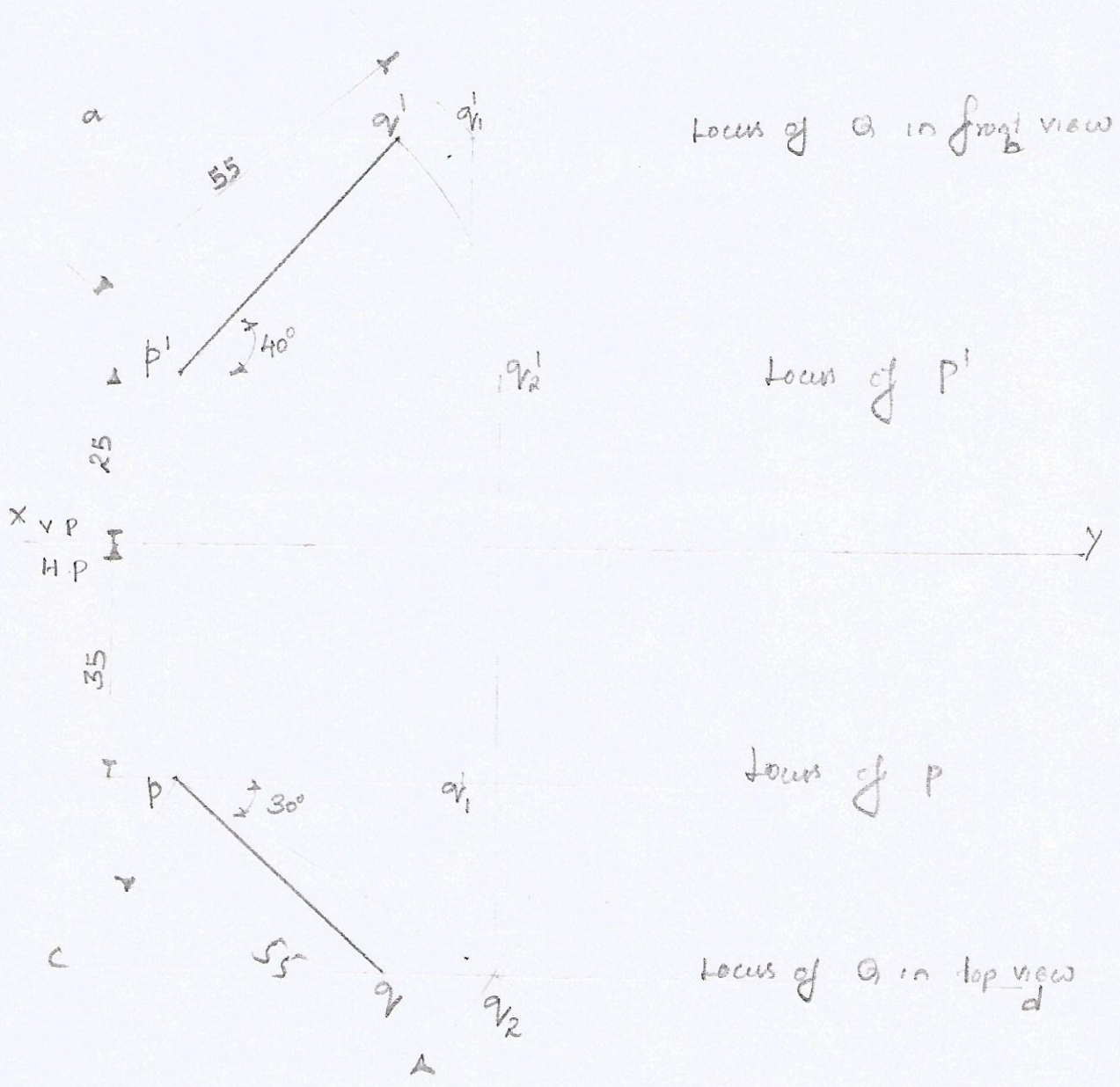

2. One end S of a line SR, 70mm long is in both the HP & the VP.
 The line is inclined at 40° to the HP and at 35° to the VP.
 Draw its Projections.

Given: True length SR = 70mm
 End S in HP & VP
 Inclination with HP = 40°
 " With VP = 35°

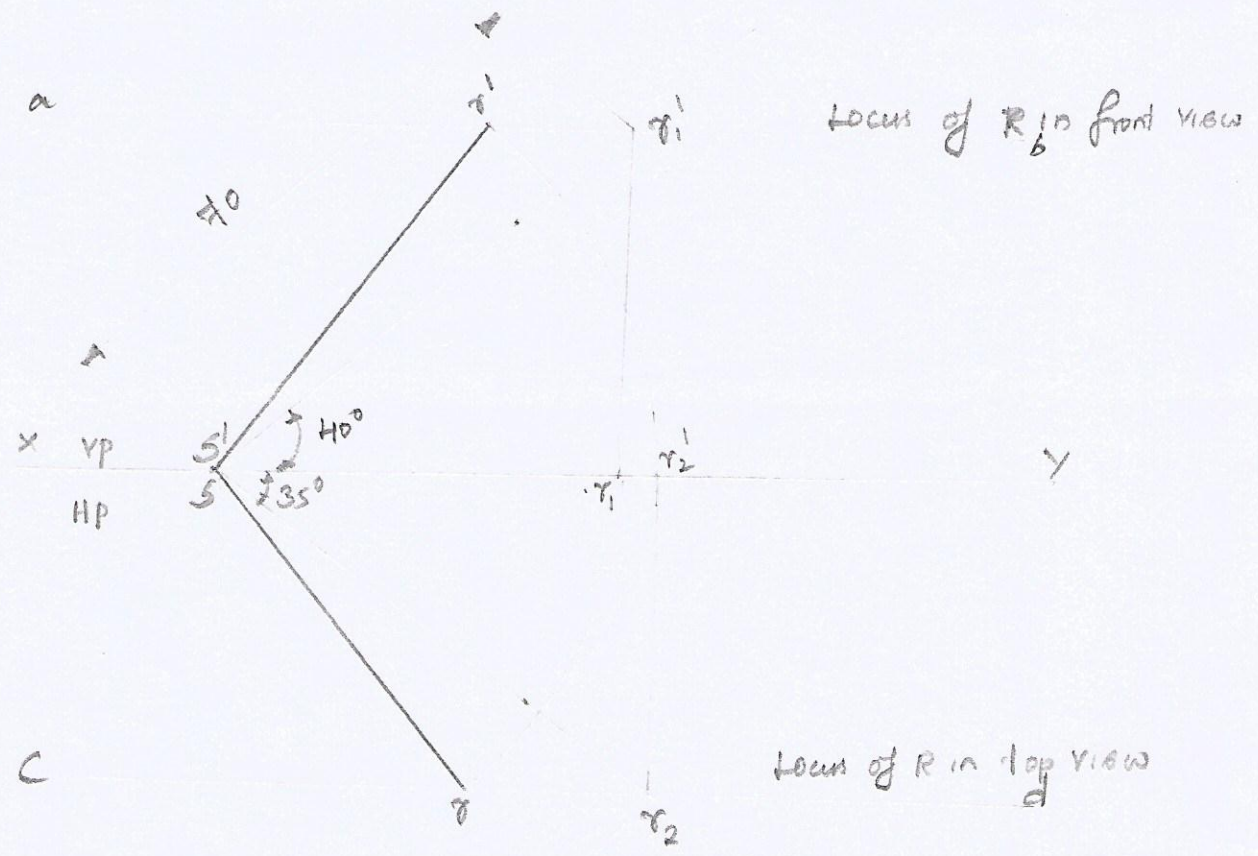

$S'r'$ → Top view
 Sr → Front view

3. A line NS, 80mm long has its end N, 10mm above the HP & 15mm in front of the VP. The other end S is 65mm above the HP and 50mm in front of the VP. Draw the projections of the line and find its true inclinations with HP & VP.

Given: True length NS = 80 mm
 End N 10 mm above HP
 15 mm in front of VP
 End S 65 mm above HP
 50 mm in front of VP

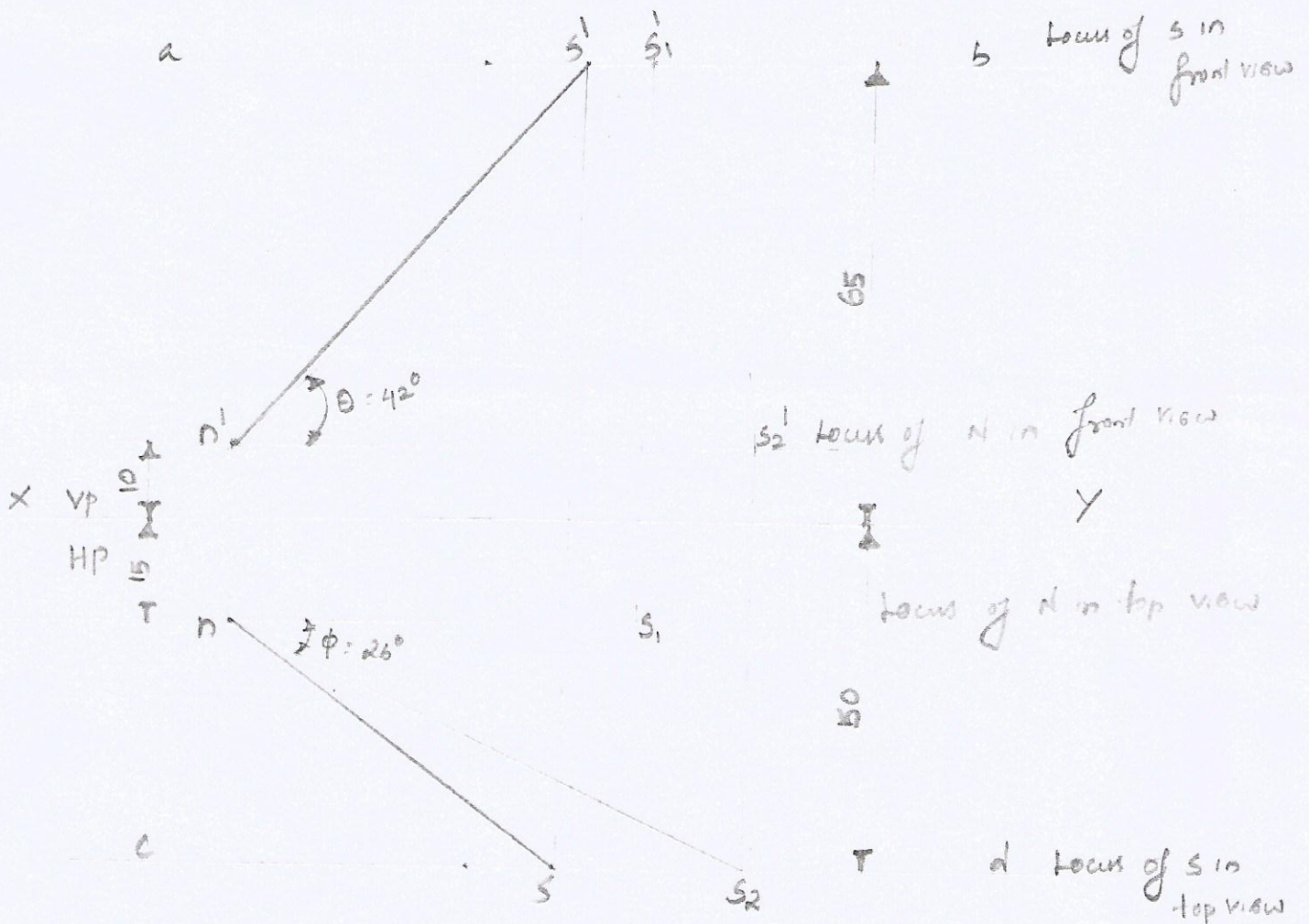

$n's' \rightarrow$ front view

$ns \rightarrow$ top view

Inclination with HP = 42°

" " VP = 26°

A. A line PF, 65mm long has its end P, 15mm above the HP and 15mm in front of the VP. It is inclined at 55° to the HP and 35° to the VP. Draw its Projections.

Given: True length $PF = 65\text{mm}$
 end P 15mm above HP
 15mm in front of VP
 Inclination with HP = 55°
 " " " " VP = 35°

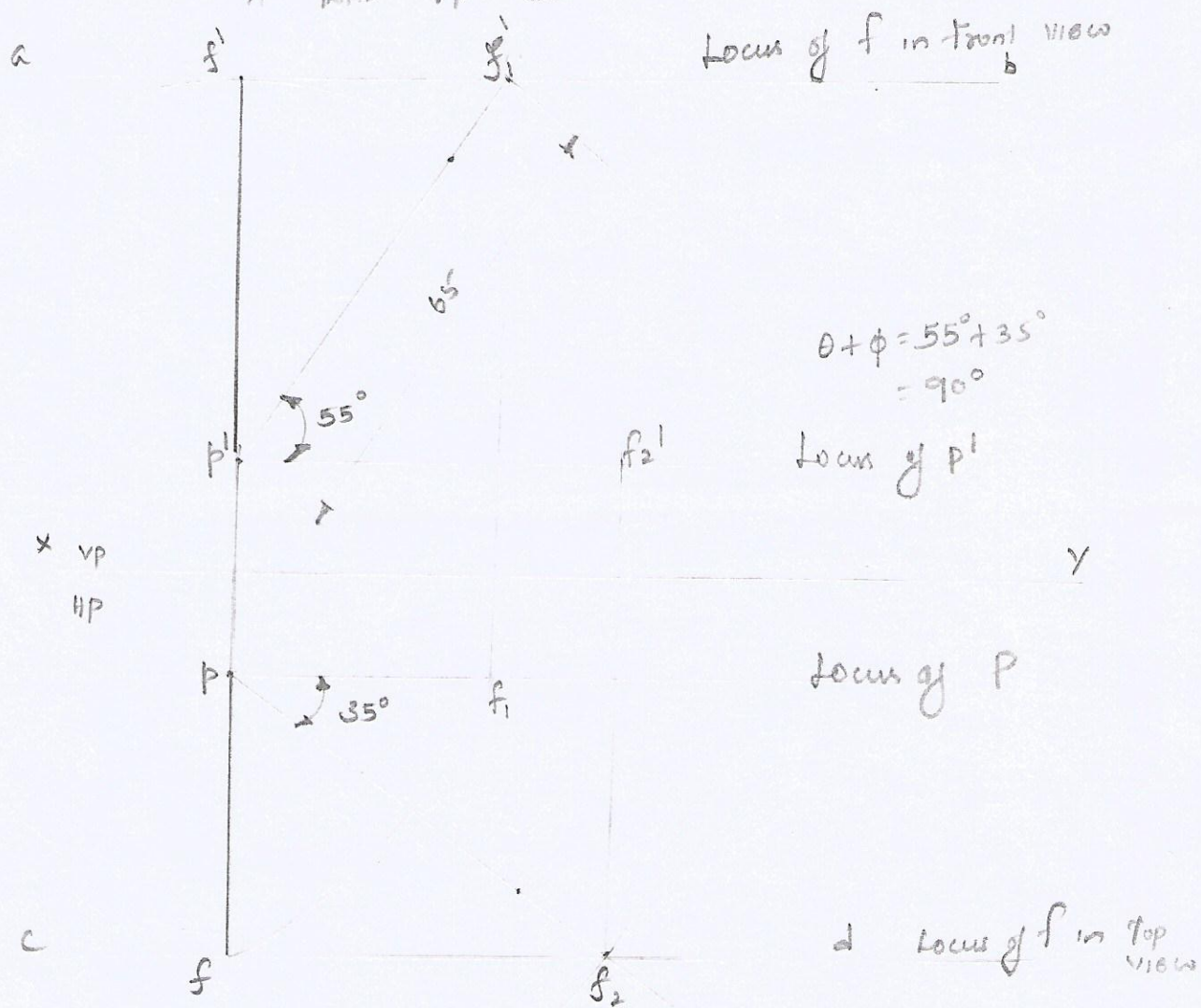

$P'f'$ - Front view

Pf - Top view

5. The end P of a line PA, 70 mm long is 15 mm above the Hp and 20 mm in front of the Vp. A is 40 mm above the Hp. Its top view is inclined at 45° to the Vp. Draw the projections of the line and find its true inclinations with the Vp & the Hp.

Given:
 True length = 70 mm PA
 End P 15 mm above Hp
 20 mm in front of Vp
 A 40 mm above Hp
 Inclination of top view $PQ = 45^\circ$
 with Vp

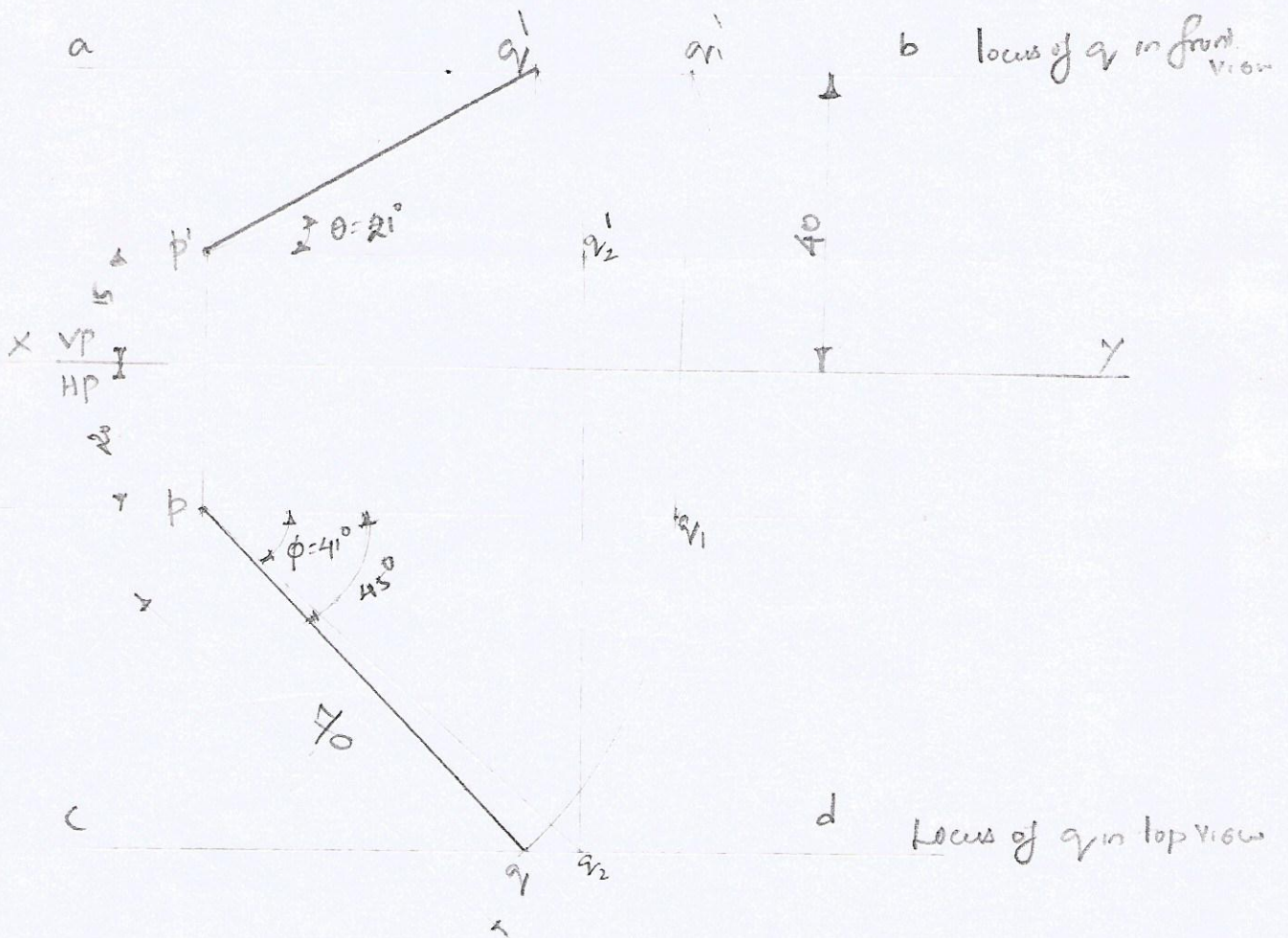

Inclination
 with Hp $\theta = 21^\circ$
 " Vp $\phi = 45^\circ$

b. A line AB, end A is 10 mm above HP and 20 mm in front of VP. The other end B is 50 mm above HP and 60 mm in front of VP. The end projectors are the same projector. Draw it's projection. Also find the true length and true inclinations with HP & VP.

Given:

End A is 10 mm above HP
 " 20 mm in front of VP

End B is 50 mm above HP
 " 60 mm in front of VP

End projectors are same. $\Rightarrow \theta + \phi = 90^\circ$

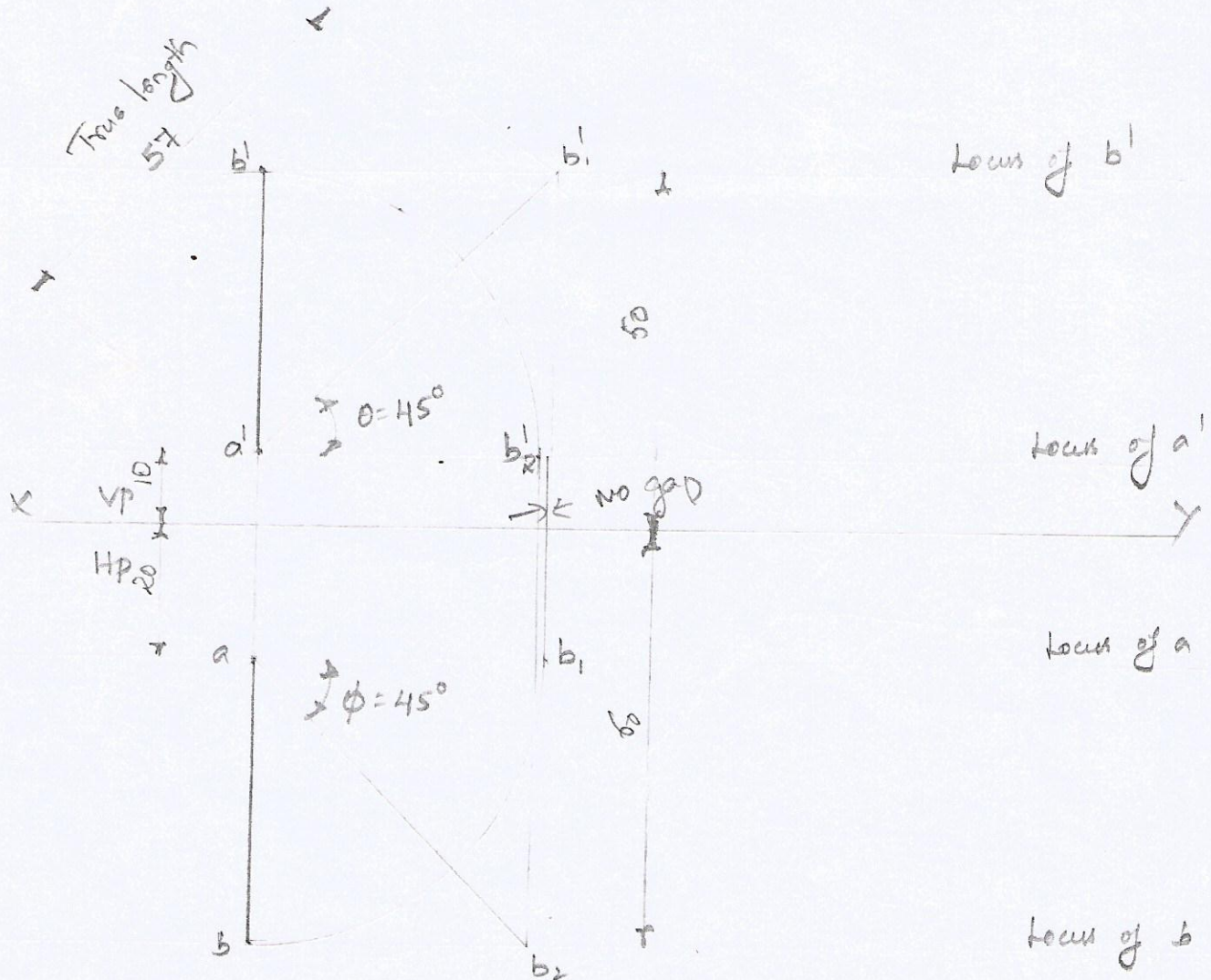

$\theta = 45^\circ$

$\phi = 45^\circ$

7. A line EF, 85 mm long has its end E, 25 mm above the HP and 20 mm in front of the VP. The top and front views of the line have lengths of 55 mm and 70 mm respectively. Draw the projections of the line and find its true inclinations with the VP and the HP.

Given

True length EF = 85 mm

End E 25 mm above HP & 20 mm in front of VP

Length of F.V. = 70 mm
T.V. = 55 mm

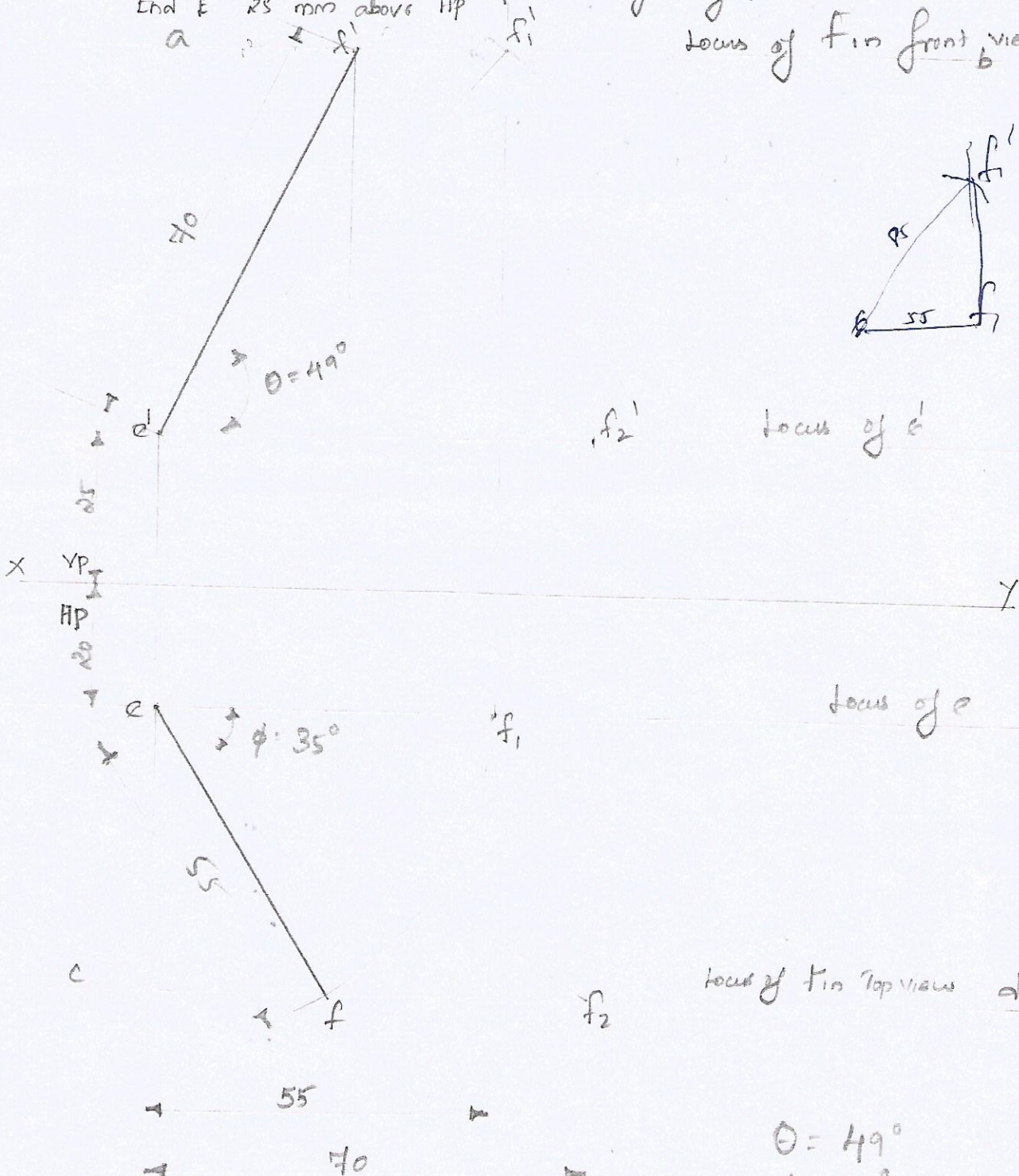

$\theta = 49^\circ$
 $\phi = 35^\circ$
 ef = Top view

8. A line PQ has its end P , 10mm above the HP and 20mm in front of the VP . The end Q is 35mm in front of the VP . The front view of the line measures 75mm. The distance b/n the end projectors is 50mm. Draw the Projections of the line and find its true length and its true inclinations with the VP and the HP .

Given:

End P 10 mm above HP
 " 20 mm in front of VP
 End Q 35 mm in front of VP
 Length of front view 75 mm
 Distance b/n end projectors = 50 mm

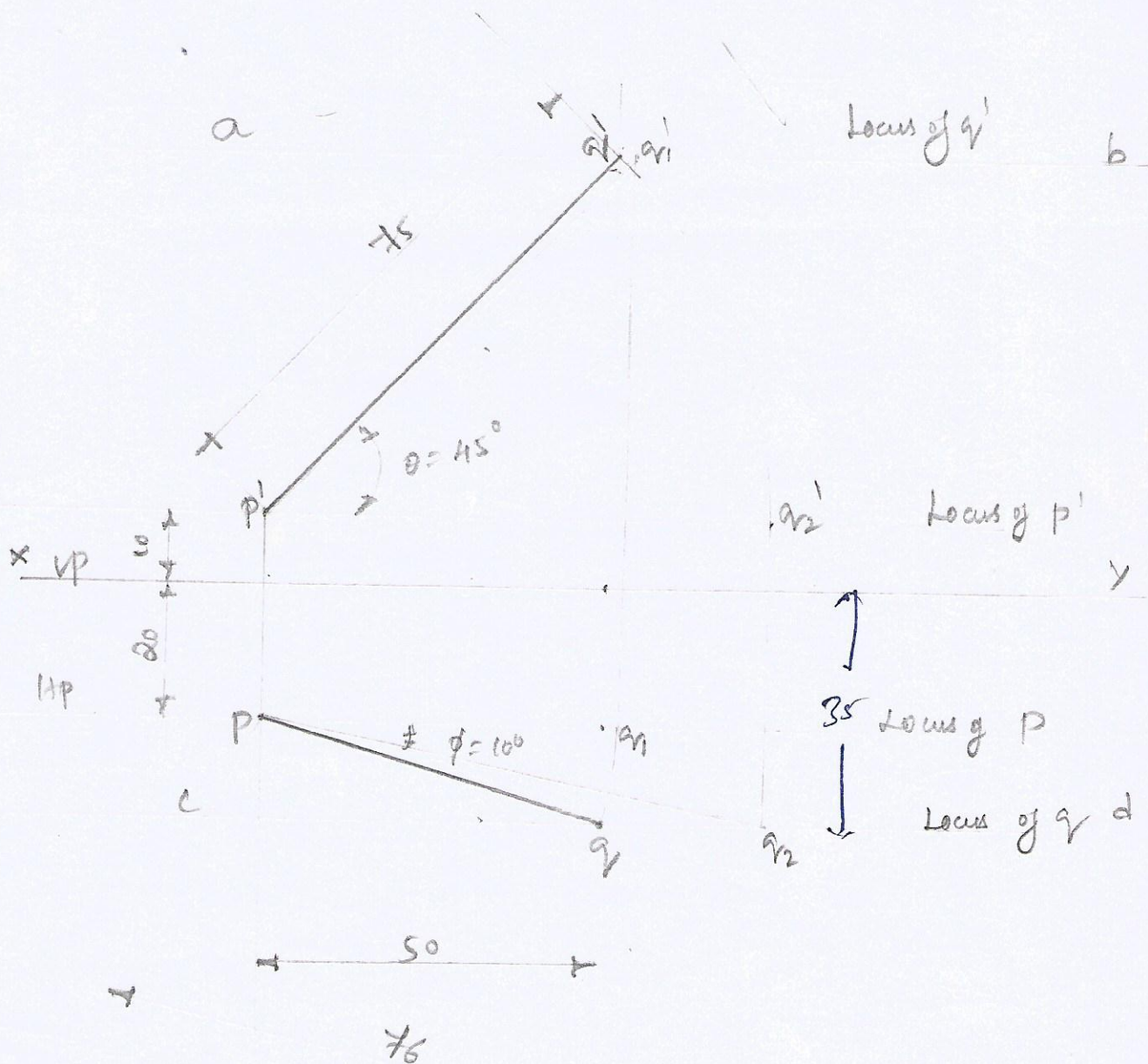

9. One end P of a line PQ, 80mm long is 25mm above the Hp and 20mm in front of Vp. (The line is inclined at 35° to the Vp, its top view has a length of 50mm. Draw the projection of the line and find its true inclination with the Hp.

Given: True length PQ = 80mm
 End P 25mm above Hp
 20mm in front of Vp
 Inclination with Vp = $\phi = 35^\circ$
 Length of Top view = 50mm

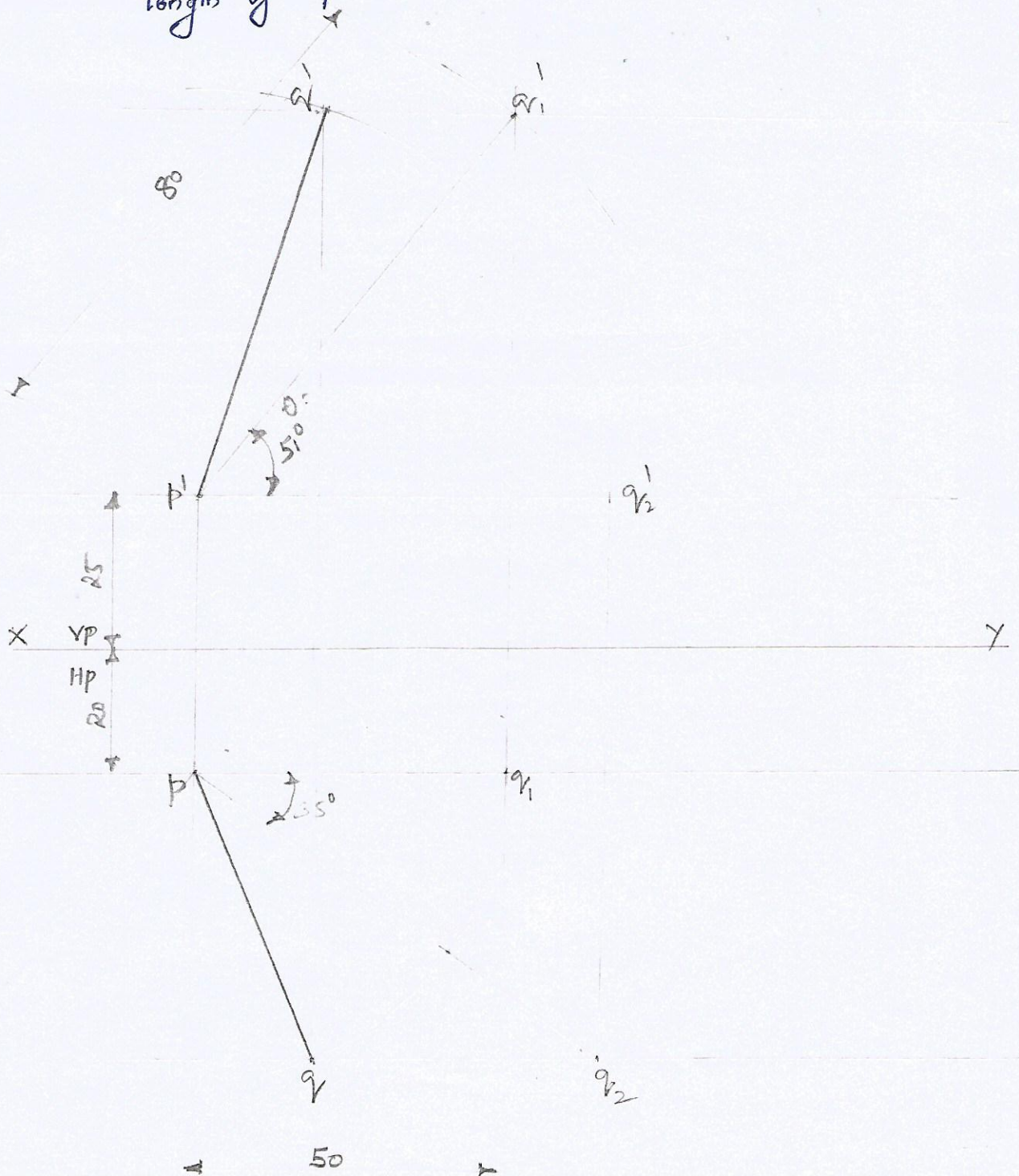

10.

A line measuring 65 mm long has one of its ends 45 mm in front of VP and 20 mm above HP. The top view of the line is 45 mm long. The other end is 20 mm in front of VP and is above HP. Draw its projections and find the true inclinations with HP & VP.

Soln.

$PQ = 65 \text{ mm}$

End P 45 mm in front of VP
20 mm above HP

Length of top view = 45 mm

Q 20 mm in front of VP & above HP

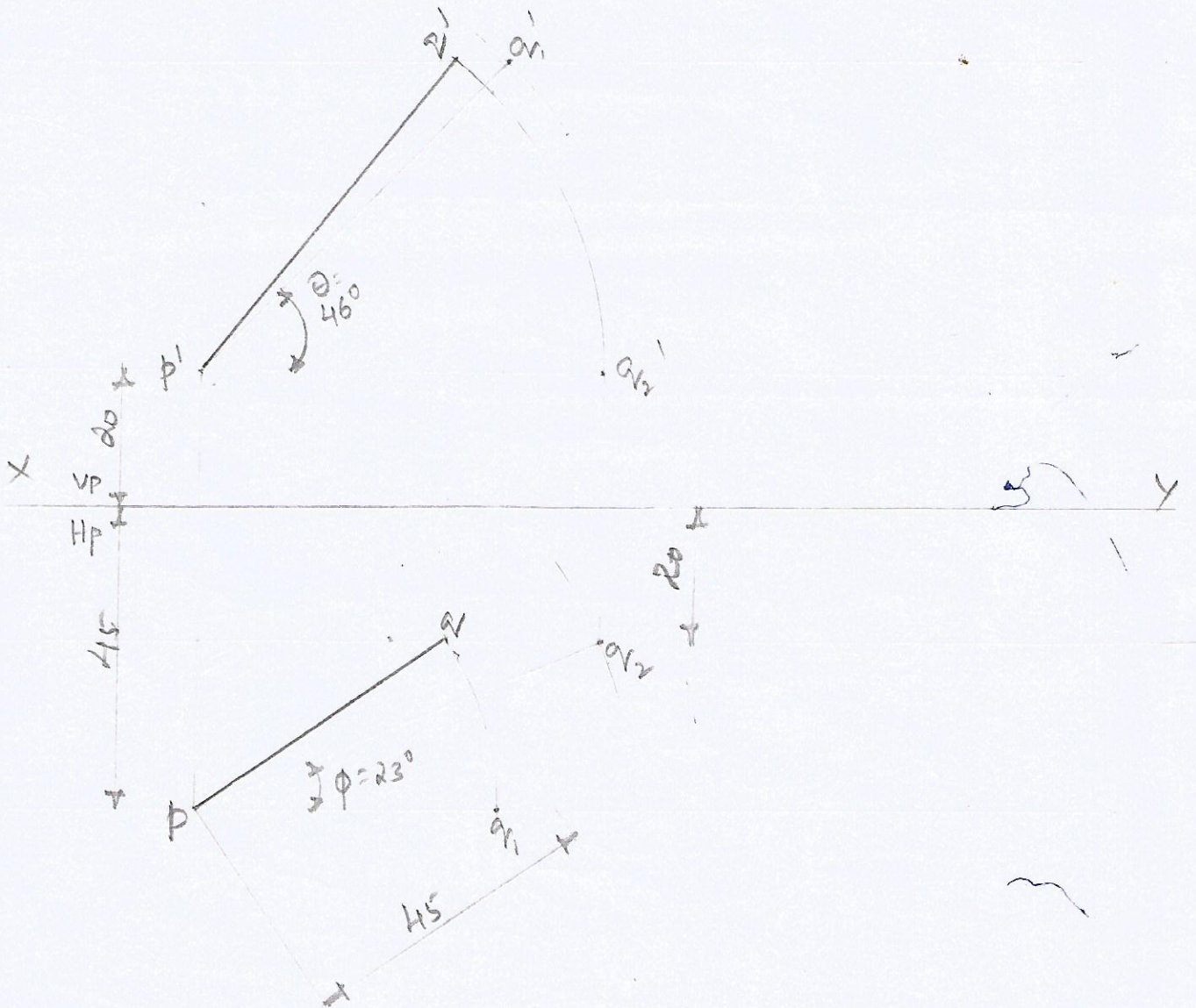

11. A straight line ST has its end S , 10mm in front of the VP and nearer to it. The mid-point of the line is 50mm in front of the VP and 40mm above the HP. The front and top views measure 100mm and 120mm respectively. Draw the projections of the line. Also find its true length and true inclinations with the HP and the VP.

- Given:
- End S 10mm in front of VP
 - Mid point 50mm in front of VP
 - " 40mm above HP
 - length of top view = 100mm
 - " front view = 120mm

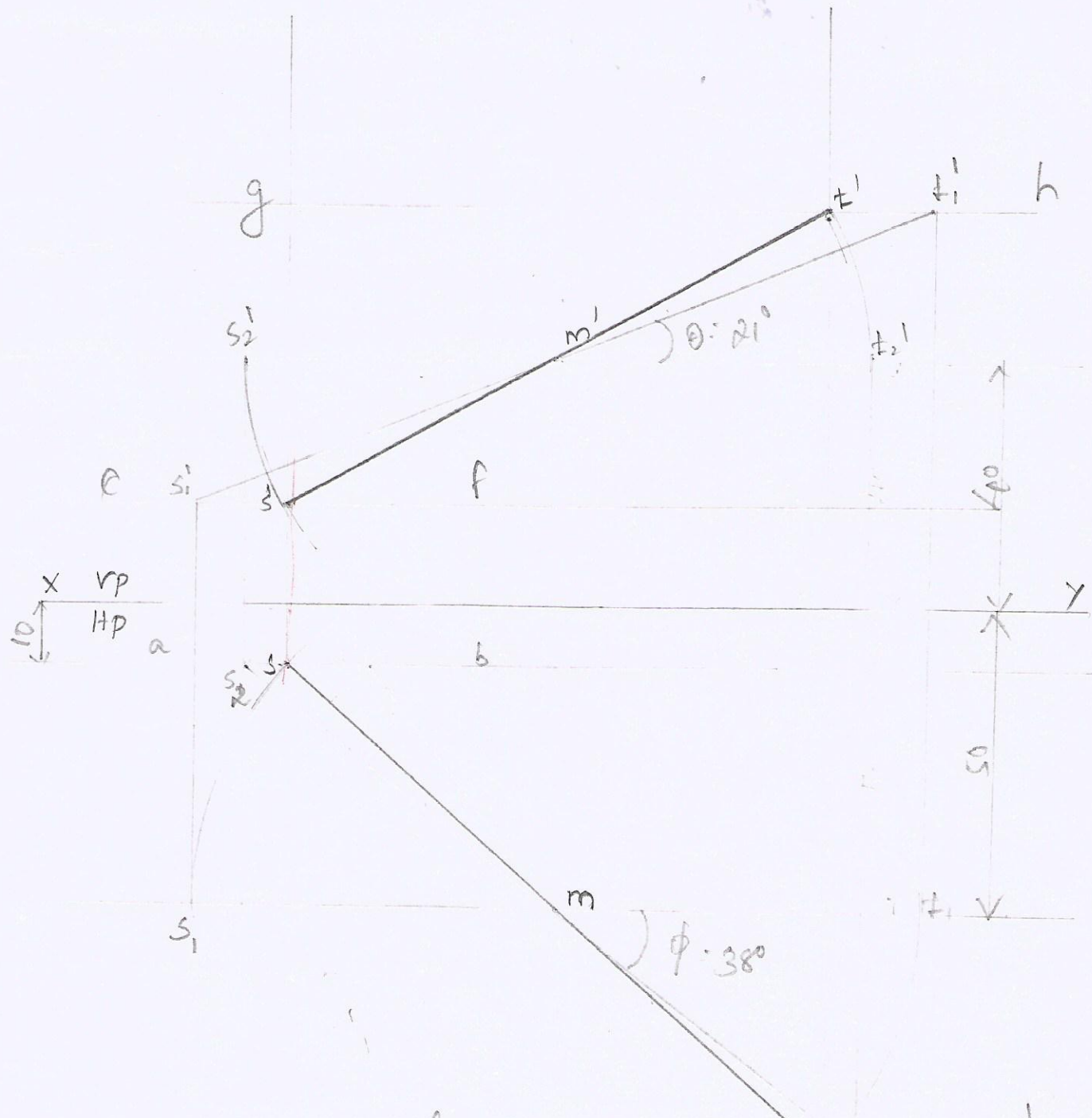

A line PQ has its ends 10 mm and 45 mm above the HP and the length of its front view is 70 mm. The line is inclined at 25° to the HP. The HT of the line is 15 mm in front of the VP. Draw the projections of the line and find its true length and true inclination with the VP. Also show its VT.

Given:

End P 10 mm above HP

Q 45 mm above HP

Length of front view = 70 mm

$\theta = 25^\circ$

HT 15 mm in front of VP.

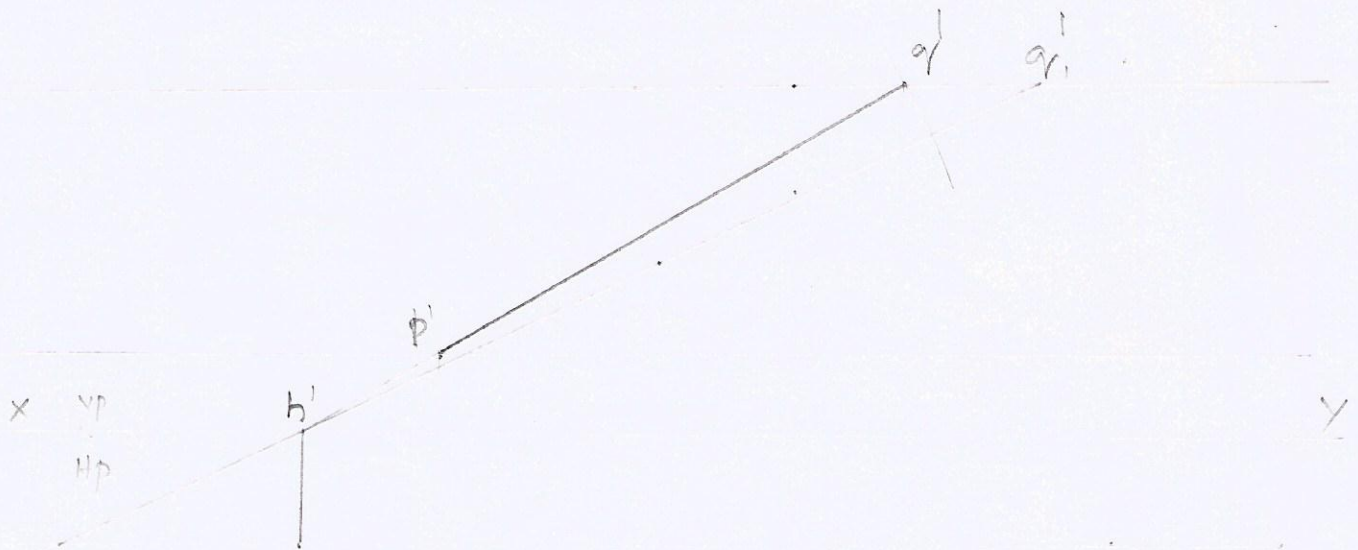

Projections of planes

Position of plane:

1. Plane \perp^r to both the reference planes
2. Plane \perp^r to the HP & Parallel to the VP.
3. Plane \perp^r to the VP & Parallel to the HP.
4. Plane \perp^r to the HP & inclined to the VP.
5. Plane \perp^r to the VP & inclined to the HP

1. Plane \perp^r to both the HP & the VP:

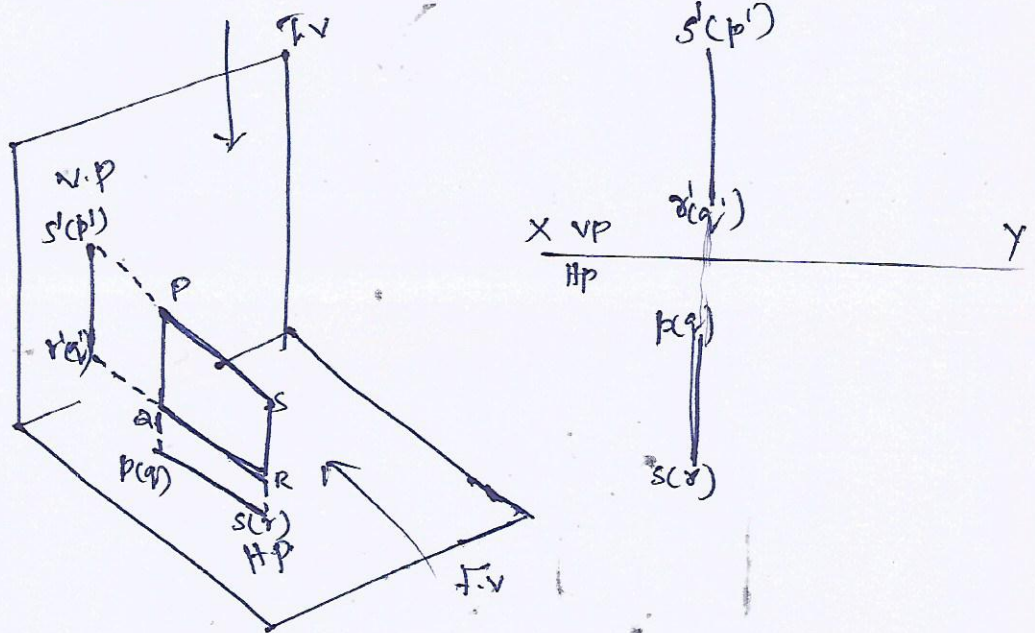

2. Plane \perp^r to the HP & Parallel to the VP:

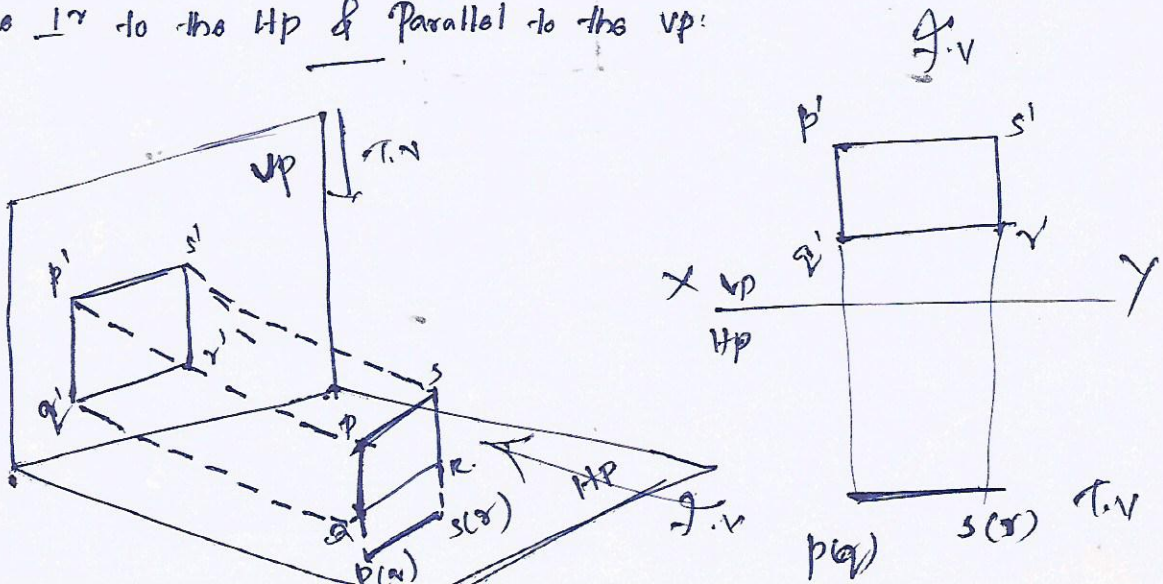

3. Plans \perp to the VP & Parallel to the Hp:

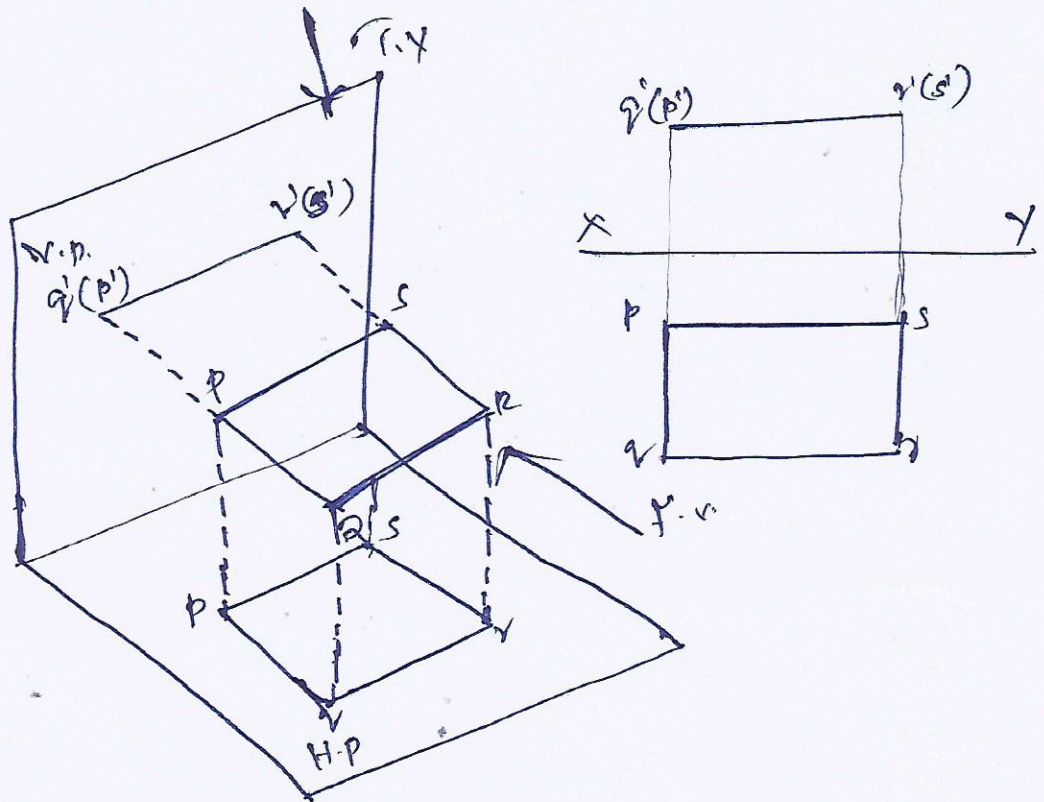

4. Plans \perp to the Hp and inclined to the VP:

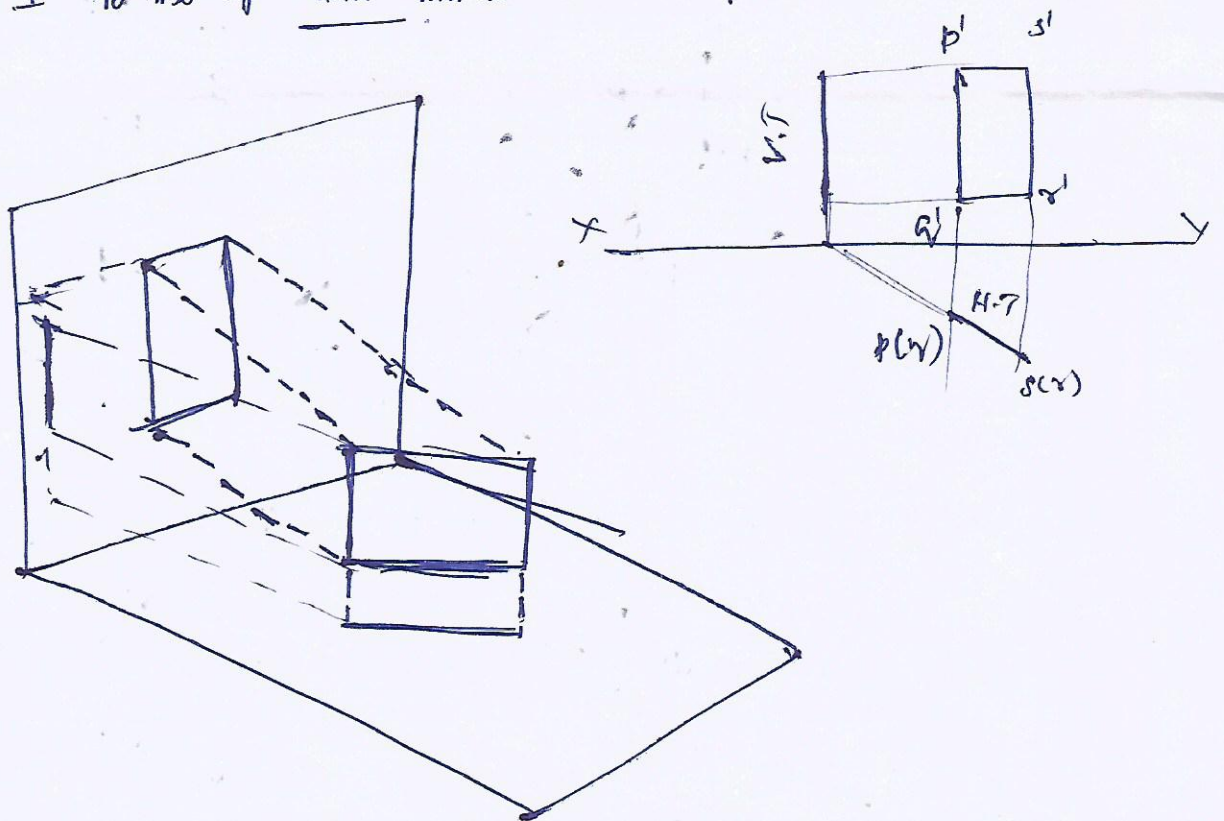

A square lamina of side 35mm is parallel to the HP with one of its sides inclined at 30° to the VP. The lamina is 20mm above the HP. Draw its top and front views and ~~show~~ its traces.

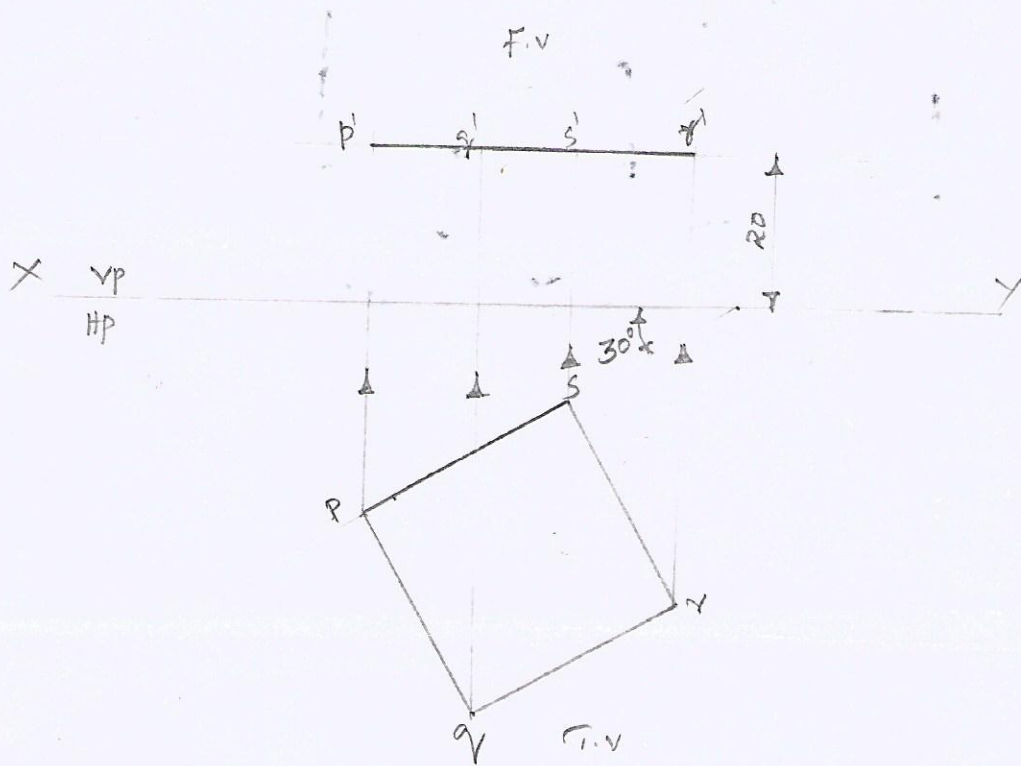

Position	
Surface Generation	
Side Inclination	

5. Plane \perp^r to the VP & inclined to the HP:

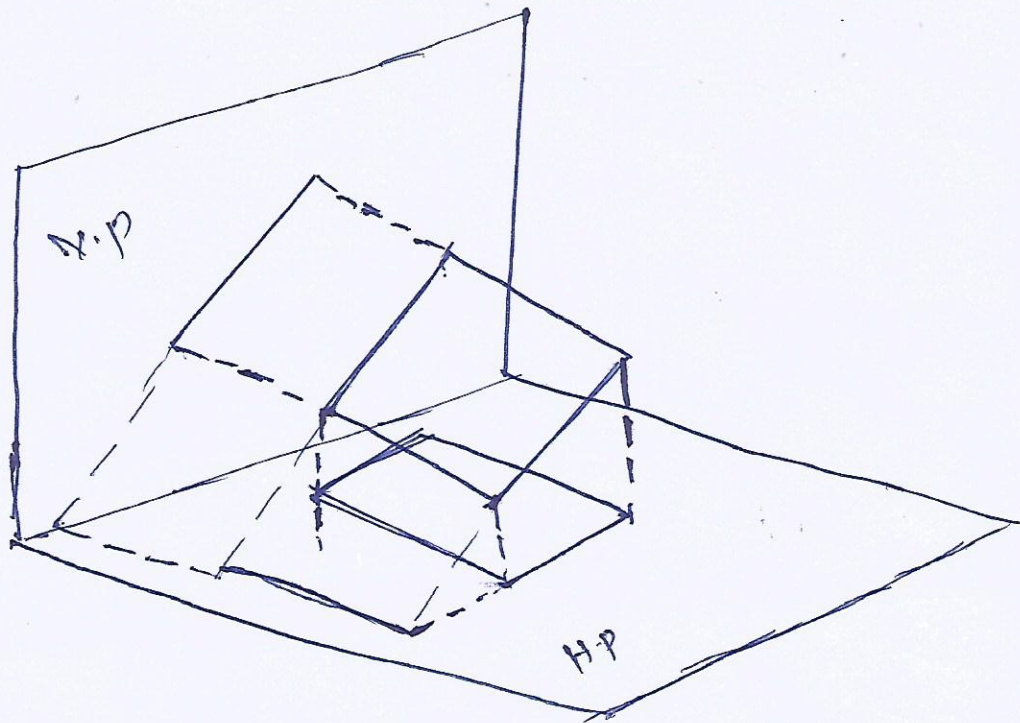

1. A square lamina PQRS of 40 mm side with one of its edges on Hp, and lamina inclined at an angle of 40° to Hp and one of its edges inclined at an angle of 35° to VP.

Position	Surface inclination	Side inclination
Edge on Hp	lamina inclined at 40° to Hp	Edge inclined at 35°

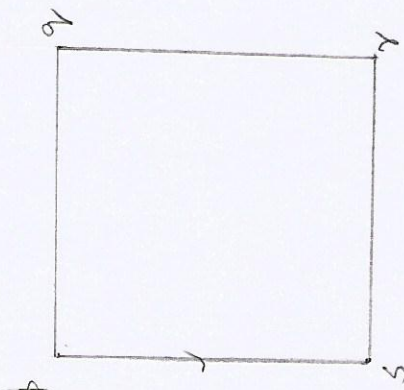
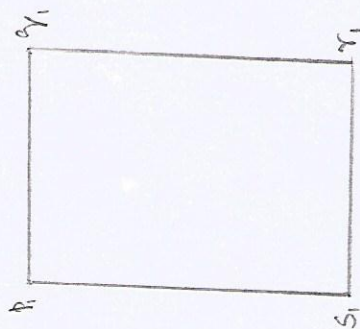
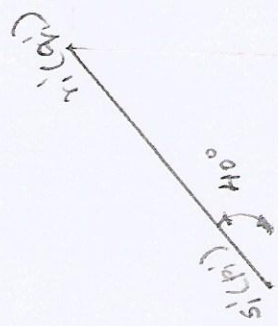
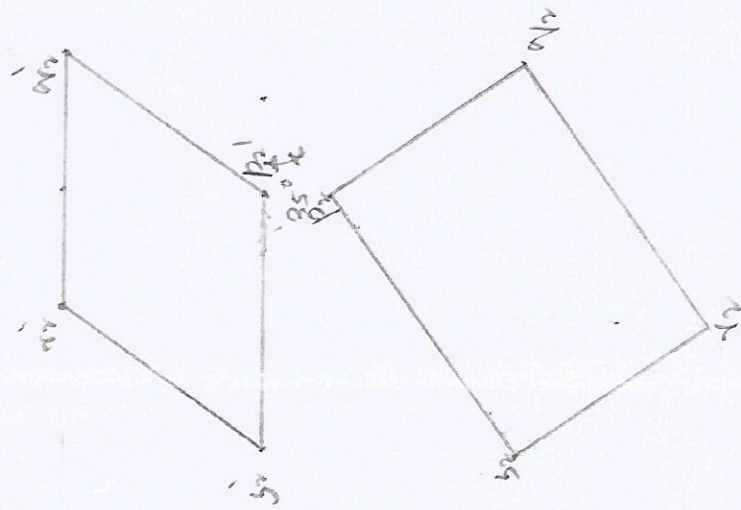

2. A Pentagon of side 40 mm is resting on the ^{HP} ground on one of its base edges, the surface of the Pentagon is inclined at 45° to HP. Draw the front and top views.

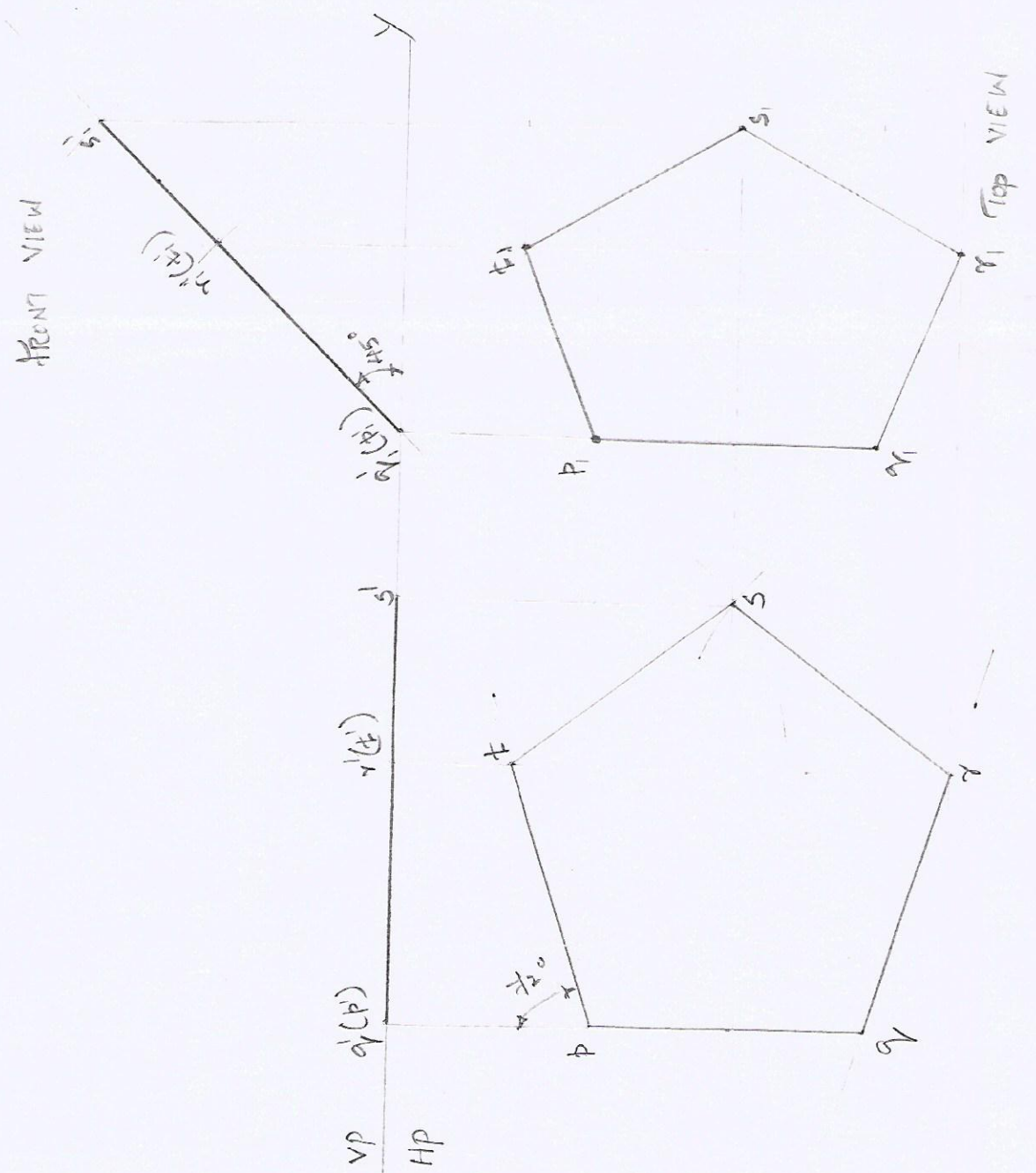
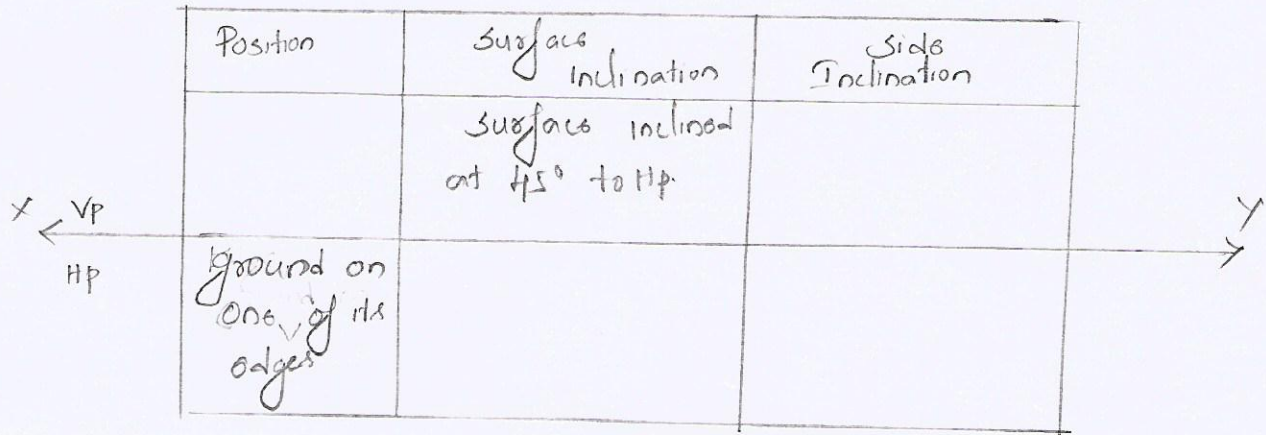

6
 Drawing side in
 the side
 side

3. A Pentagon of side 35mm is resting on V.P on one of its edges. Side
 The surface of the Pentagon is 40° to V.P. Draw its Projection.

Position	Surface Inclination	Side Inclination
Edge resting on VP		
	Surface 40° to VP	

← x VP
HP

Y →

FRONT VIEW

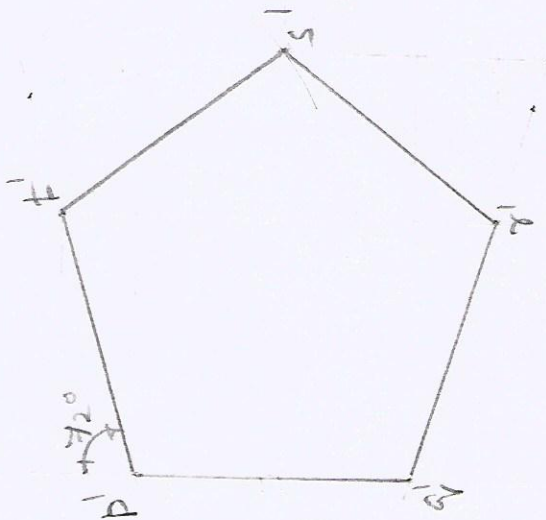
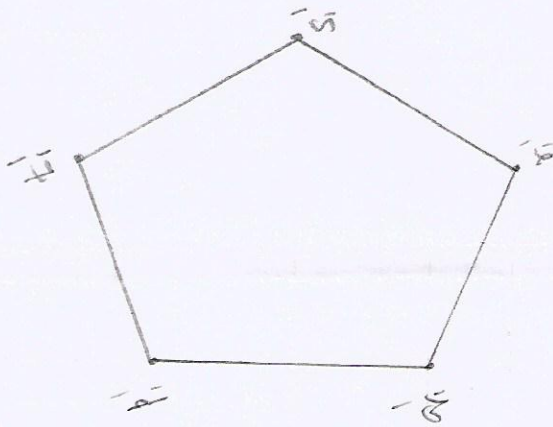

Y

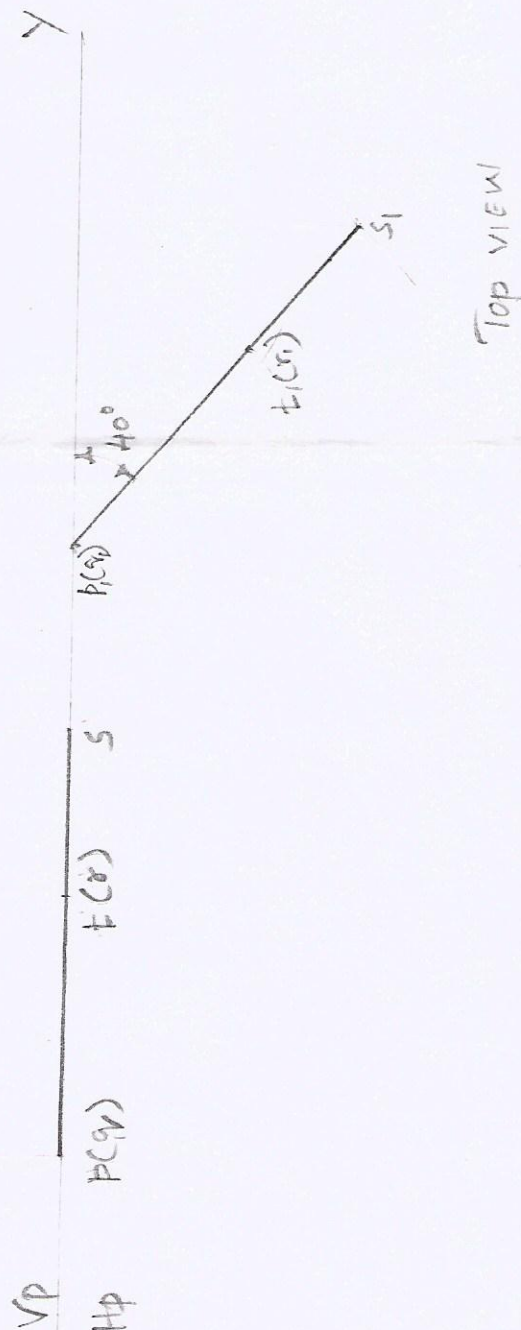

TOP VIEW

VP
HP

4. A Pentagon of side 30mm rests on the ground on one of its corners with the sides containing the corner being equally inclined to the ground. The ~~side~~ ^{side} opposite to the corner on which it rests is inclined at 30° to the VP and is parallel to the HP. The surface of the Pentagon makes 50° with the ground. Draw the top & front views of the Pentagon.

H.W.
rest on VP.
corner resting on HP

Position	Surface Inclination	Side Inclination
rest on ground on one of its corner	Surface 50° with ground (HP)	Side opposite to the corner is 30° to VP.

FINAL FRONT VIEW

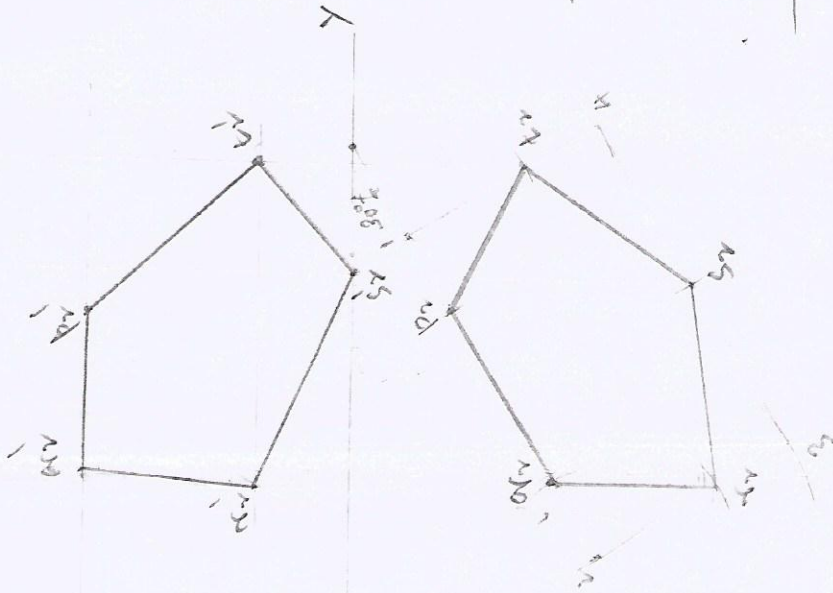

FINAL TOP VIEW

First the draw the shape then 1:2:1

TRUED SURFACE

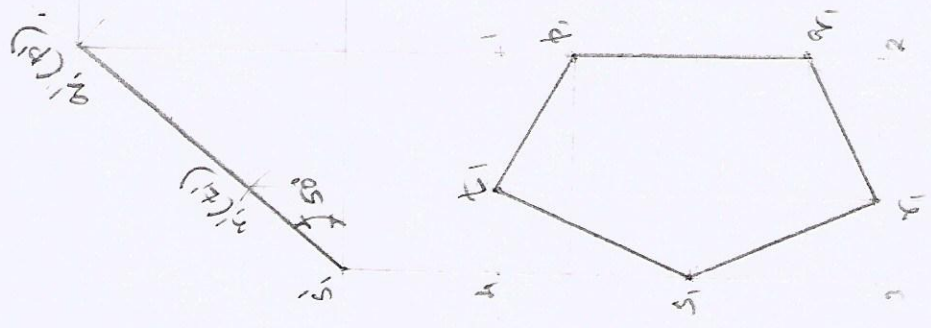

rest on ground the corner in left side

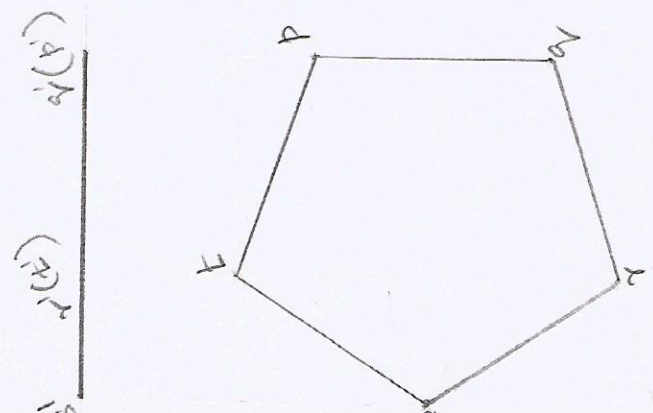

5. A hexagonal plate of side 20mm rests on the Hp on one of its sides inclined at 45° to the vp. The surface of the plate makes an angle of 30° with the Hp. Draw the front & top views of the plate.

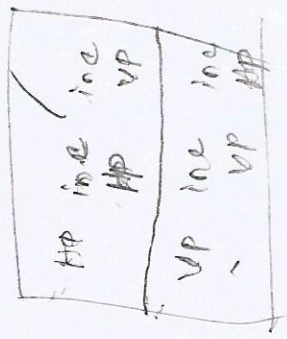
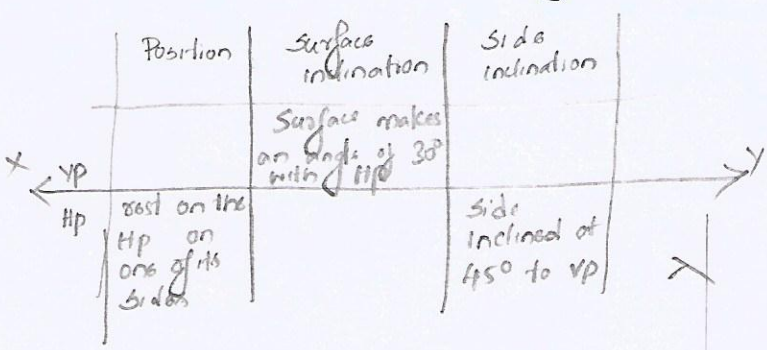

FINAL FRONT VIEW

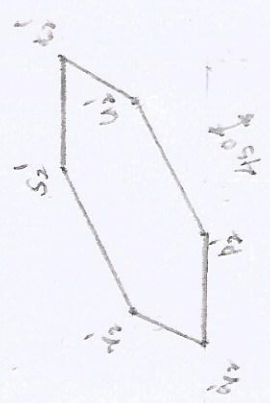

FINAL TOP VIEW

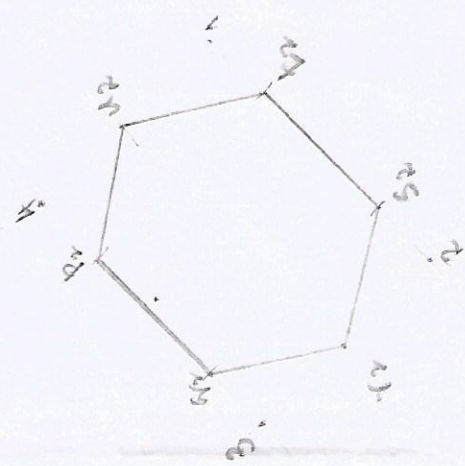

TILTED SURFACE

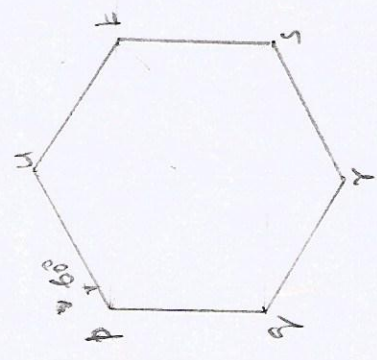
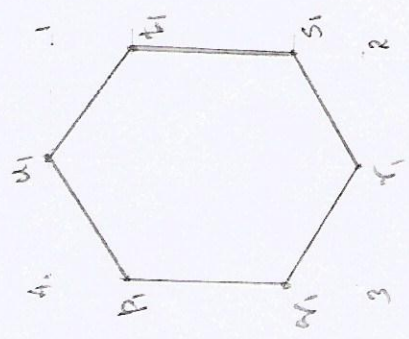
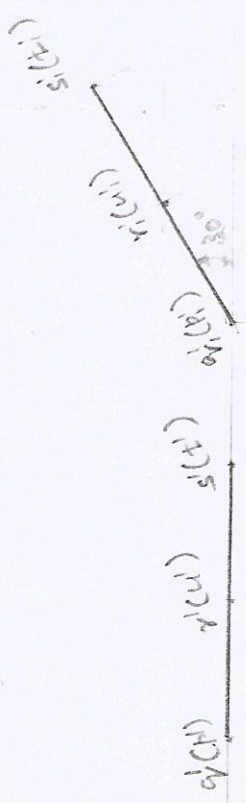

6. A hexagonal lamina of side 30mm is resting on V.P. on one of its side and resting edge is inclined at 40° to H.P. It's surface is inclined at 35° to V.P. Draw its Projection.

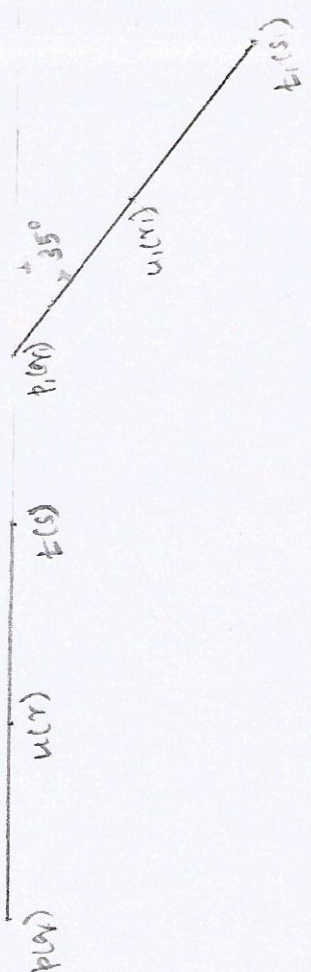
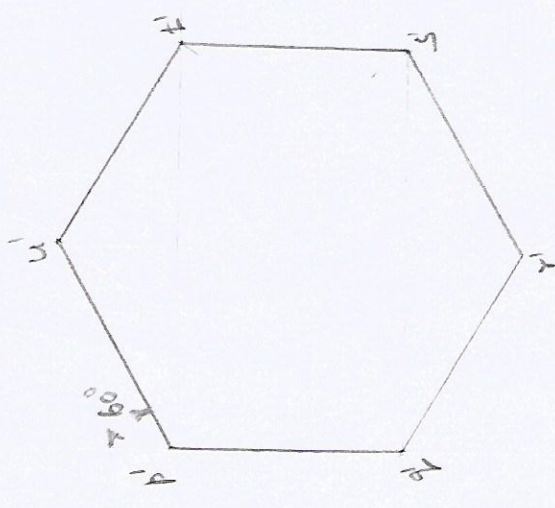
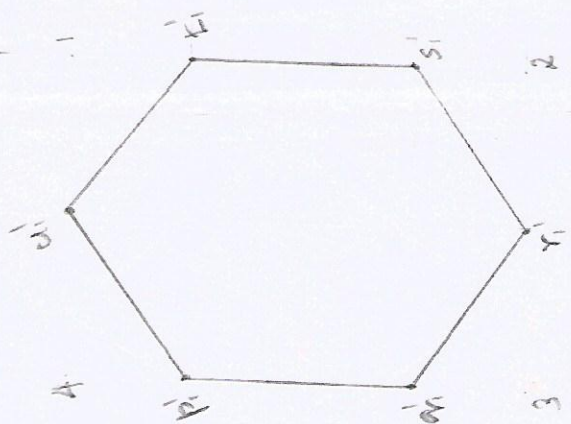
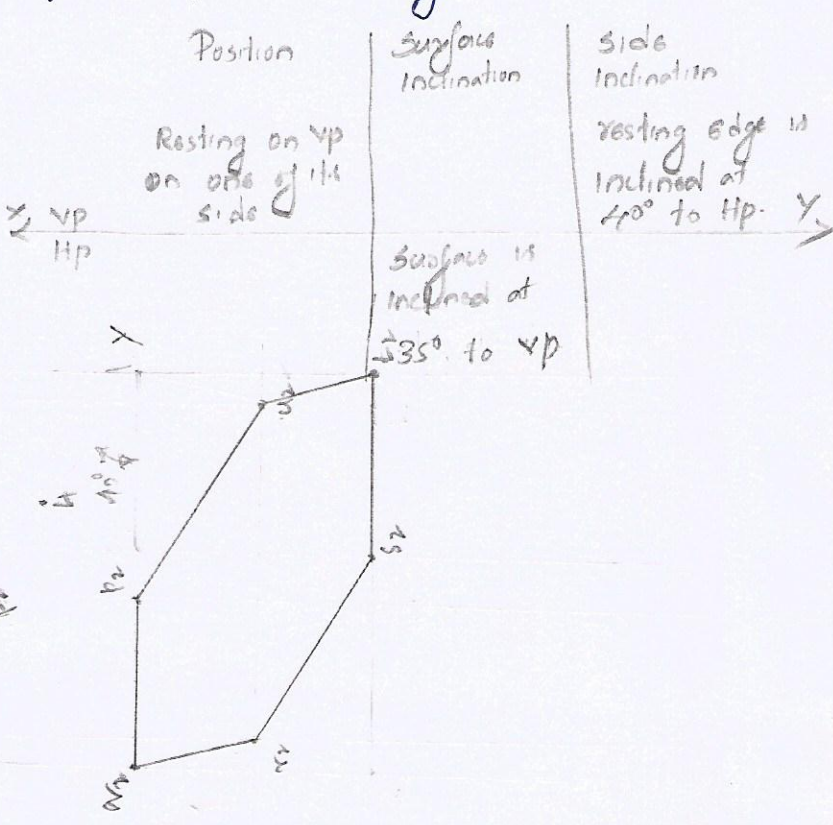
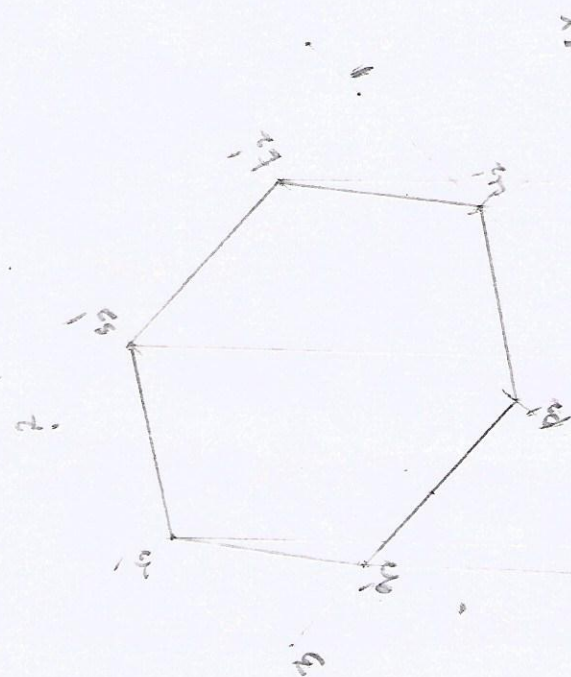

7. A square lamina PQRS of side 40 mm rests on the ground on its corner P in such a way that the diagonal PR is inclined at 45° to the HP and apparently inclined at 30° to the VP. Draw its Projections.

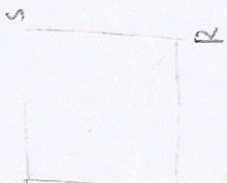
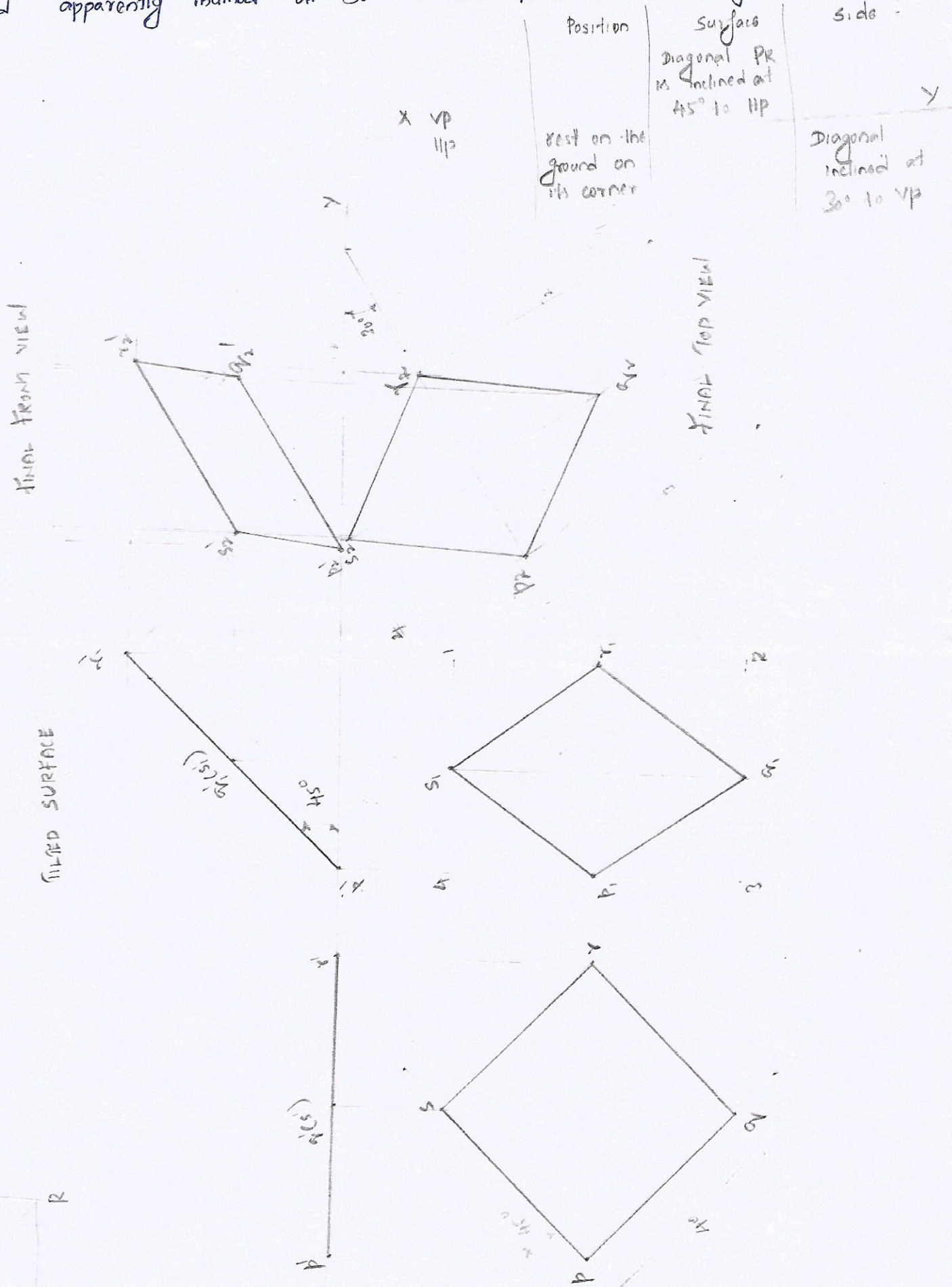

8. A circular plate of diameter 70mm has the end P of the diameter PQ in the HP and the plate is inclined at 40° to the HP. Draw its projections when the diameter PQ appears to be inclined at 45° to the VP in the top view.

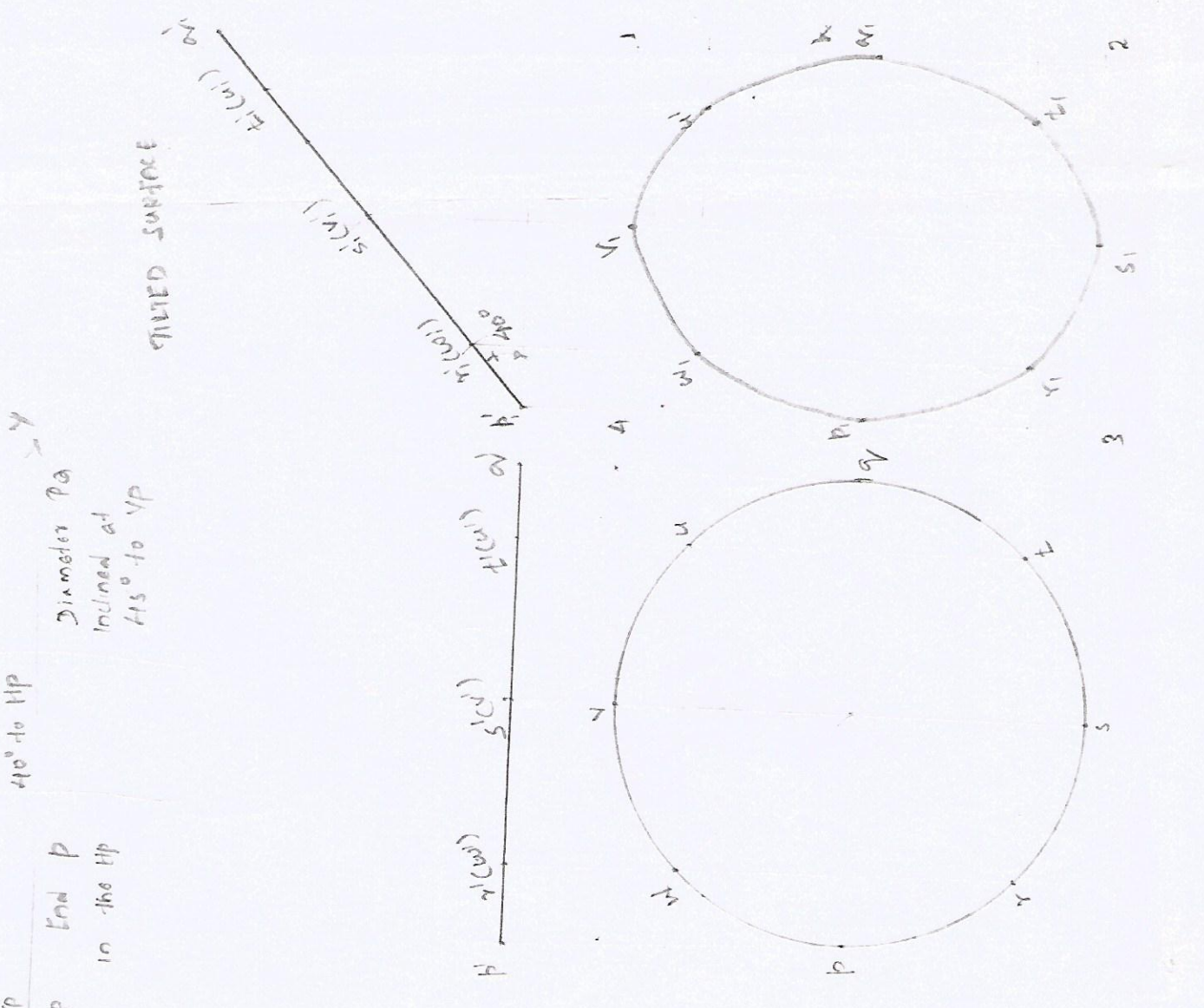
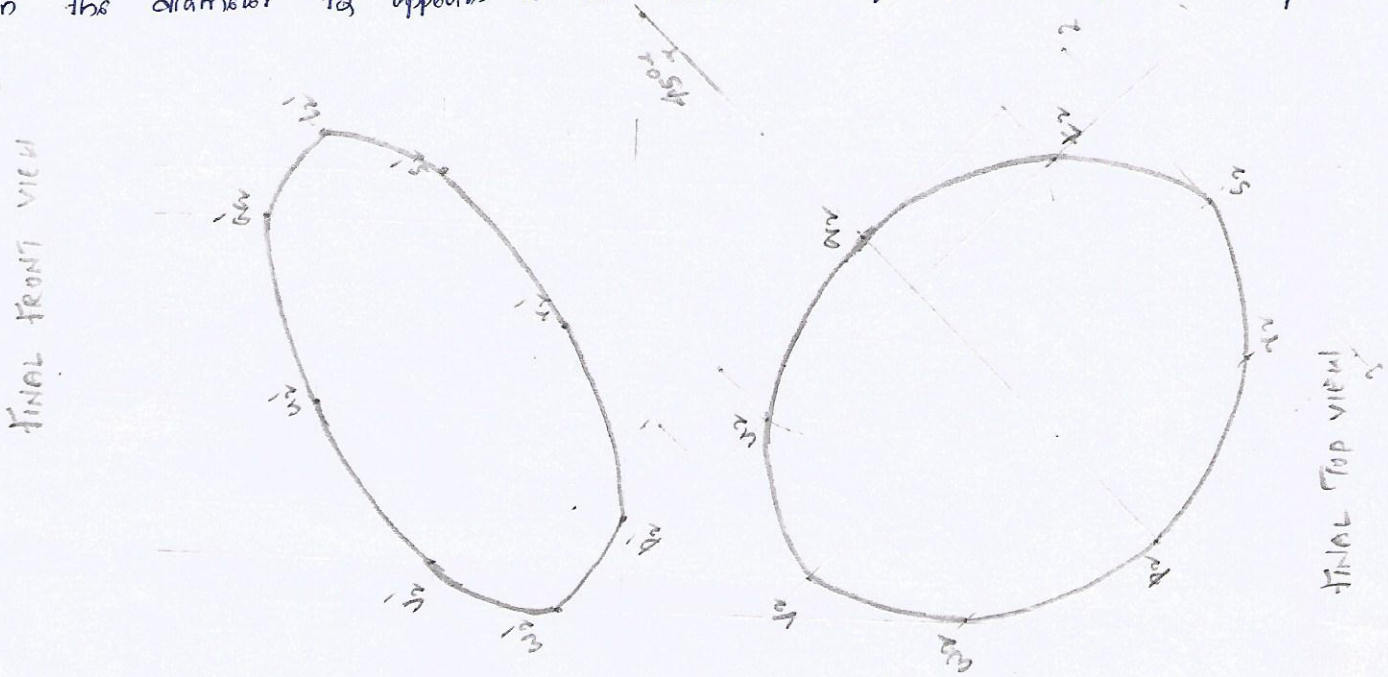

Position	Surface	Side
VP	Plate is inclined at 40° to HP	Side
HP	End P in the HP	
VP	Diameter PQ inclined at 45° to VP	

Unit. III

Projections of solids

Cylinder

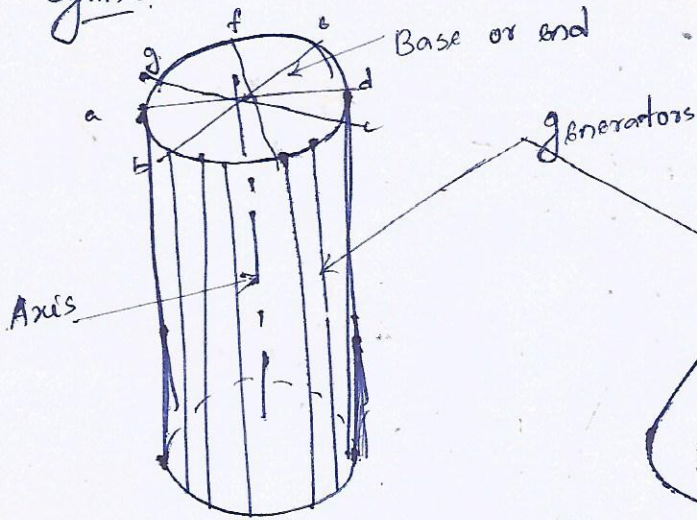

Cone

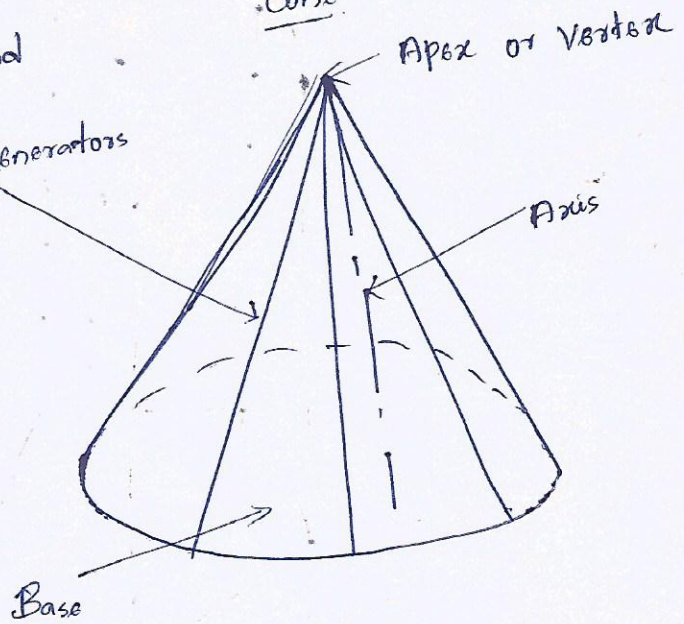

Triangular Prism

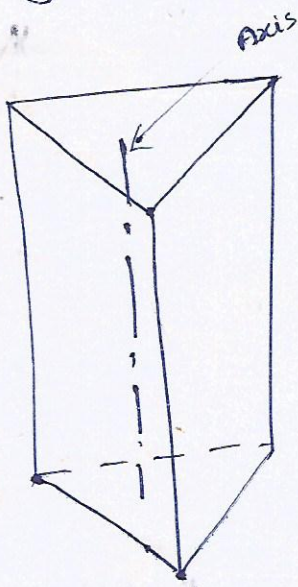

Square Prism

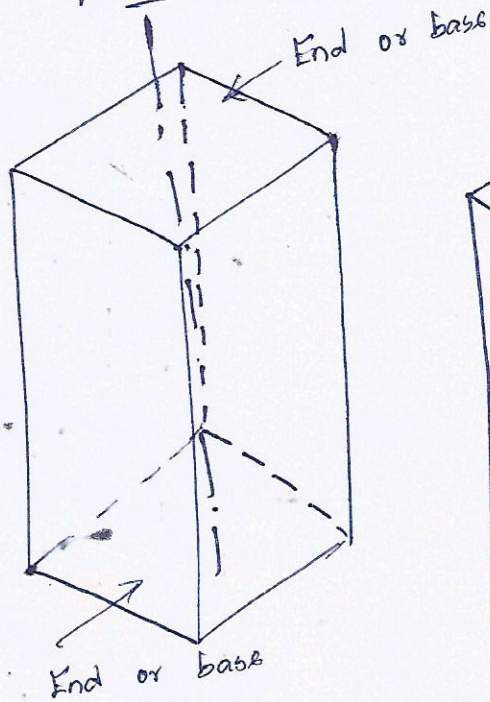

Rectangular Prism

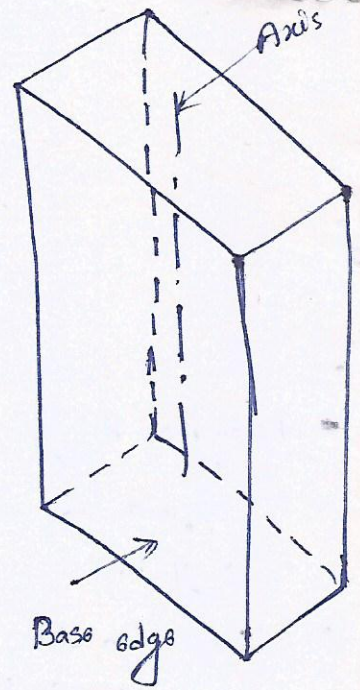

Pentagonal Prism

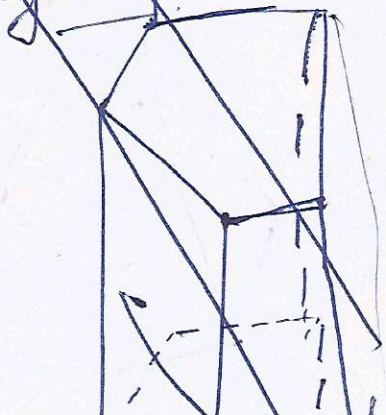

Pentagonal Prism

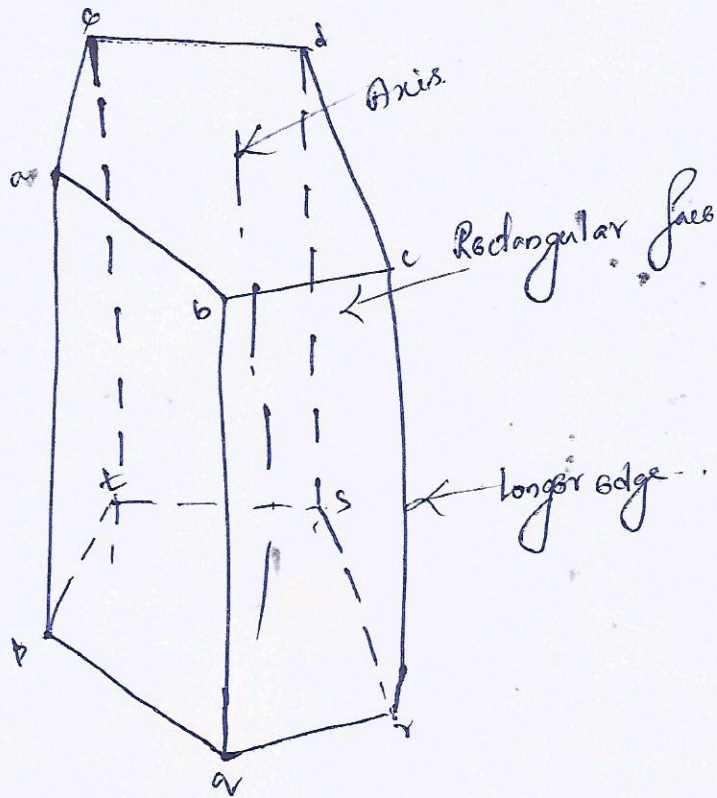

Hexagonal Prism

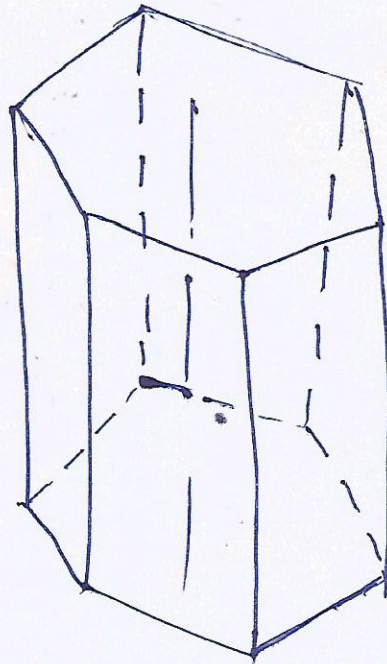

Pentagonal Pyramid

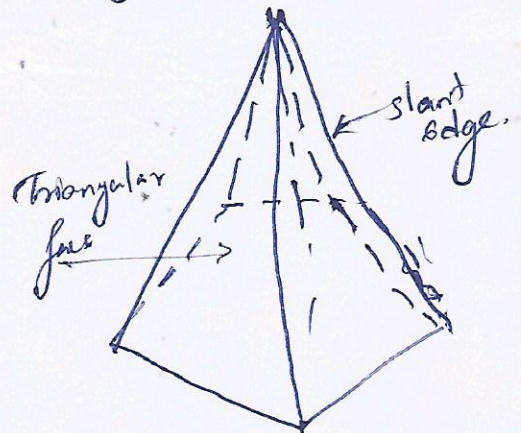

Hexagonal Pyramid

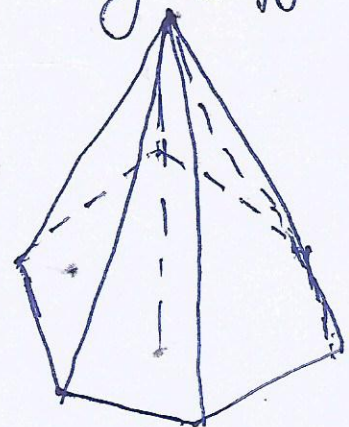

- Resting on Hp / ground
front view touches the X-y line
- Inclination with Hp : means draw the circle, Pentagon etc in Hp.
- Lying on Hp means front view touches the X-y line.

Vp - means top view

Base inclined at 45° to the HP

Axis inclined at 45° to the HP

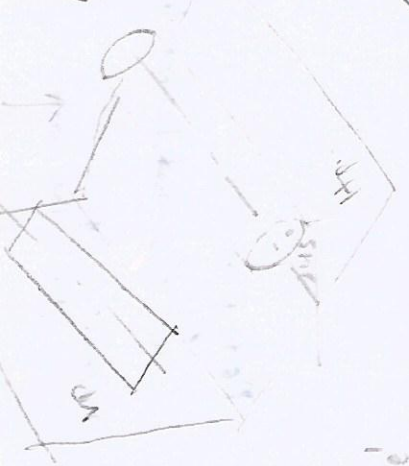

1. A cylinder of diameter 40mm and axis length 50mm is resting on the HP on a point, so that its ^{Base} axis is inclined at 45° to the H.P. and parallel to the V.P. Draw its projection.

base Angle = 90° - Axis angle
H/W Resting on the VP
 Base & axis inclined at 45° to the HP

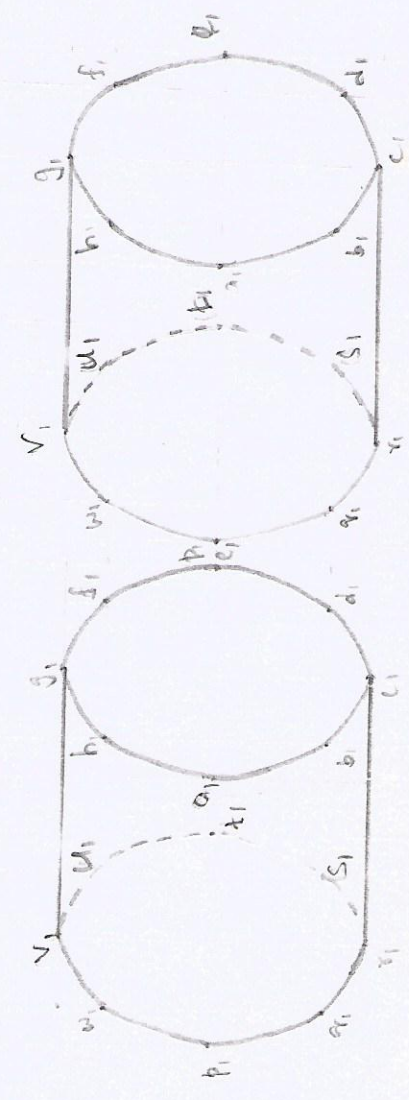
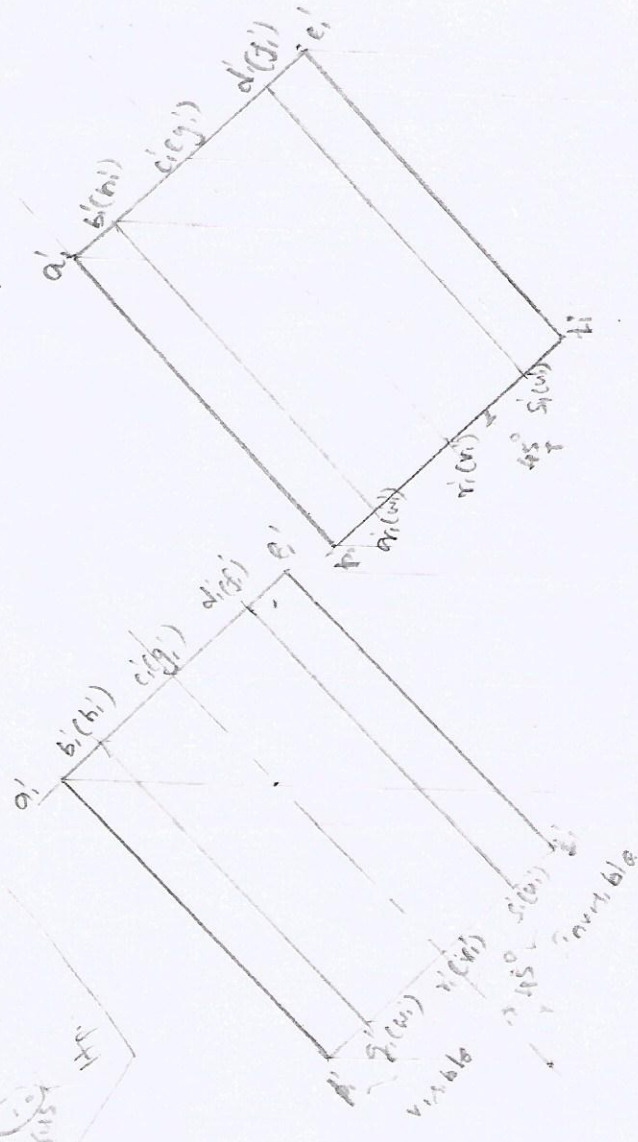
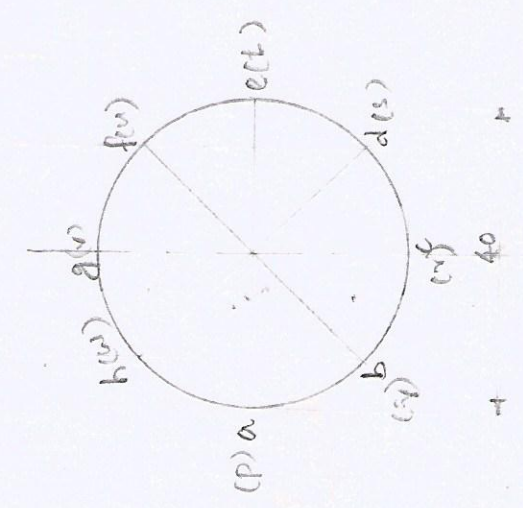
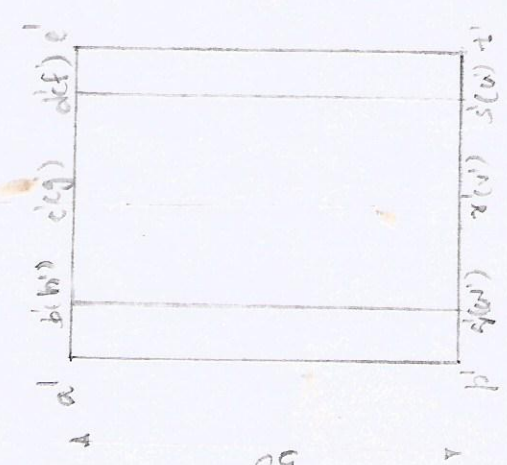

Resting on HP
 ... front view touches the XY line
 inclined to HP : draw the circle in HP

2. A cone of base diameter 40mm and altitude 70mm is resting on V.P. with its base axis inclined at 30° to V.P. Draw its Projections.

H.W. resting on HP with its axis (or) Base inclined at 30° to V.P.

Base inclined at 30° to VP



VP
Axis inclined to VP at 30° to VP

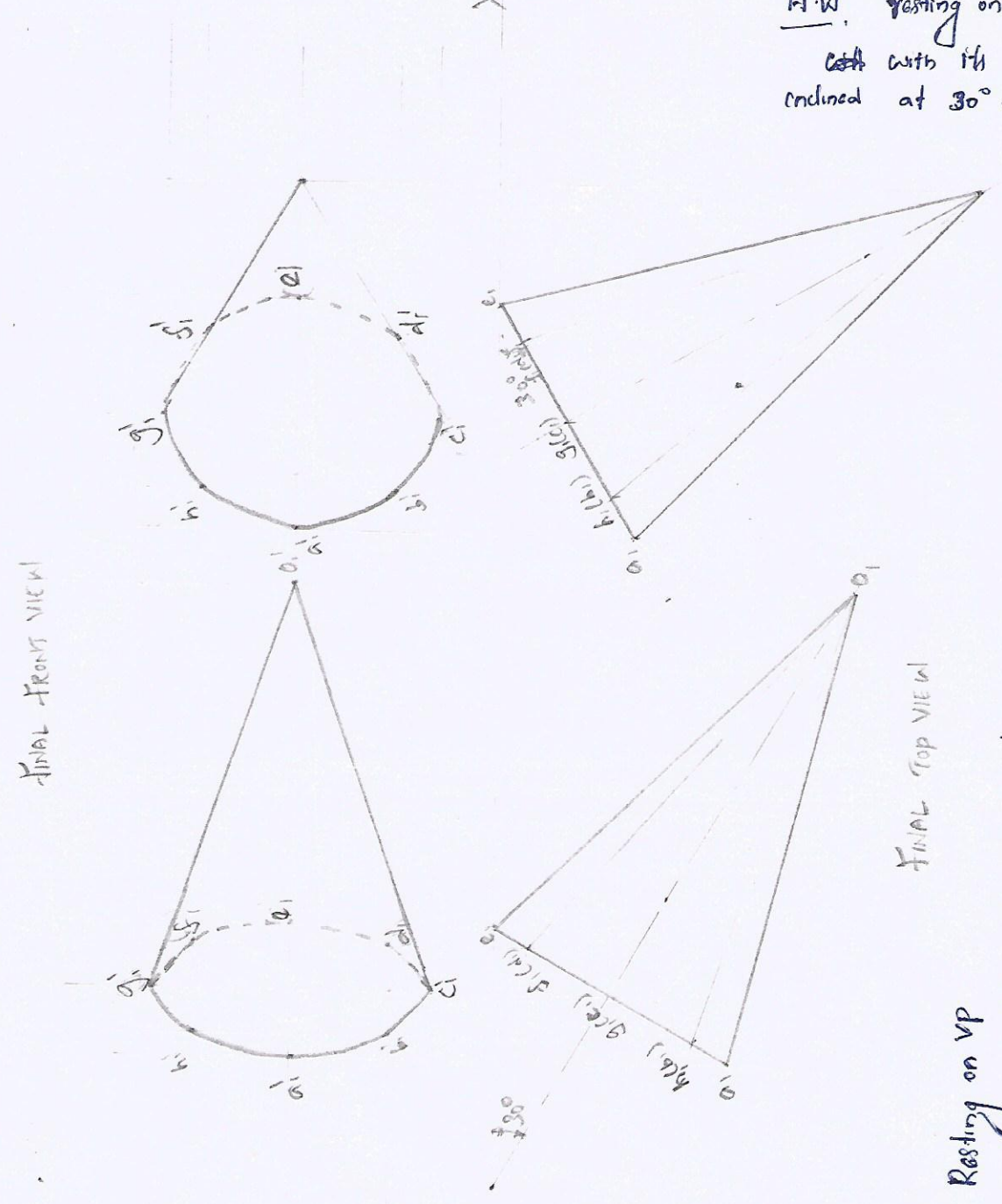

Resting on VP
 \therefore Top view ~~touches~~ touches the x-y line
 Inclined to VP
 \therefore Draw the circle in VP.

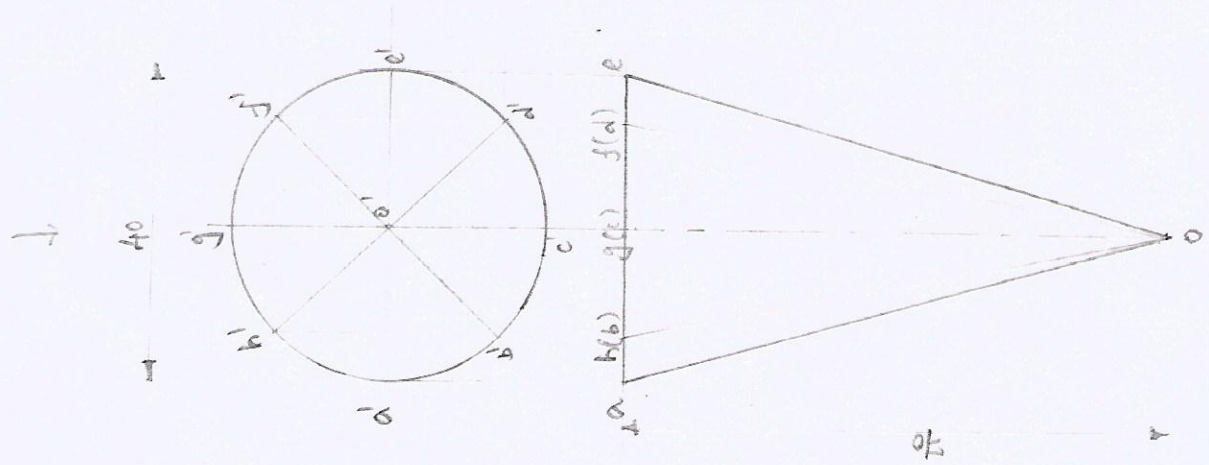

3. Draw the Projection of a cylinder of diameter 50mm and axis length 80mm when it is lying on the ground on one of its generator, with its axis inclined at 45° to V.P.

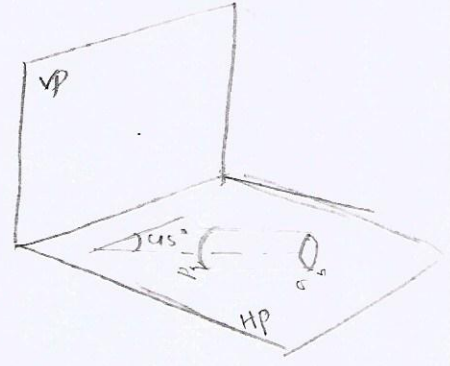

Lying on ground i. front view shows the xyline
 Inclined to VP: Draw the circle in VP
 FINAL FRONT VIEW

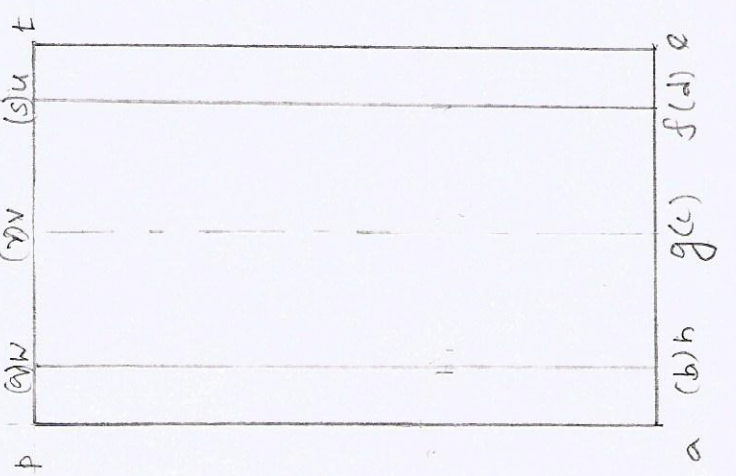
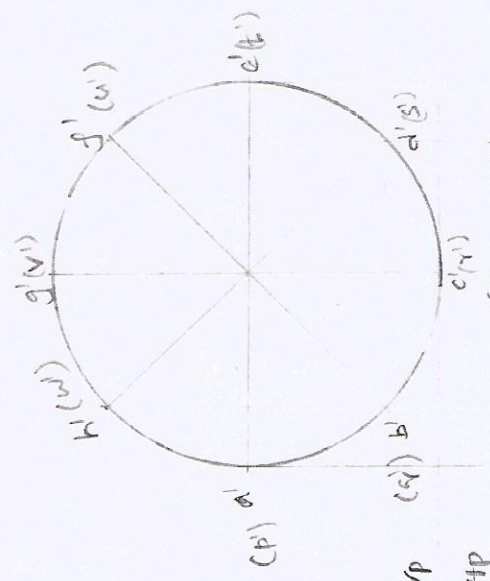
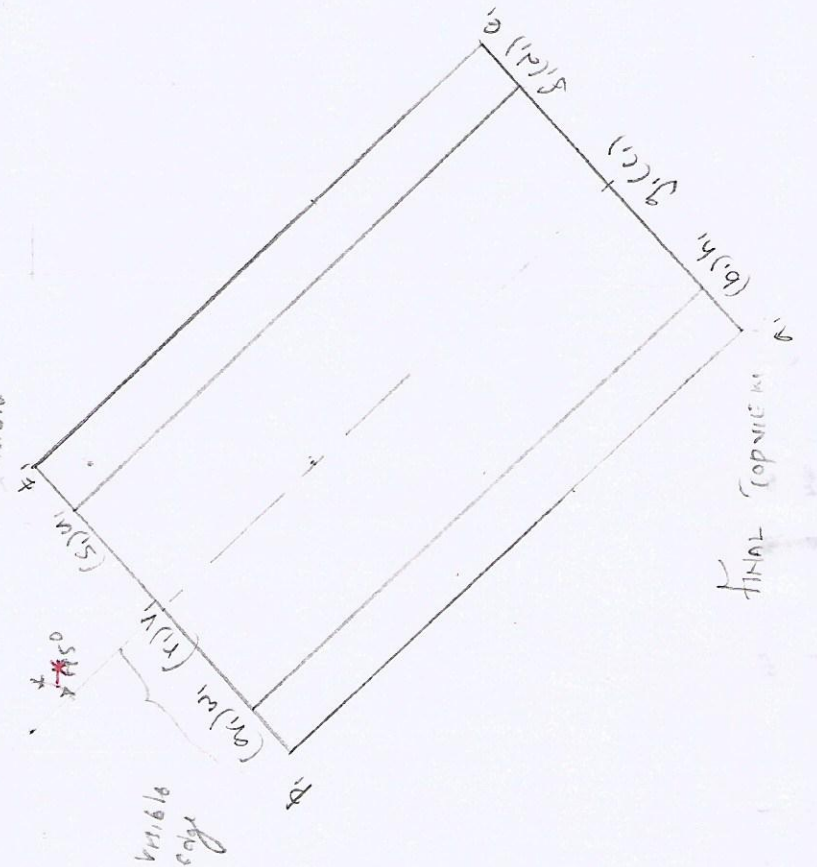
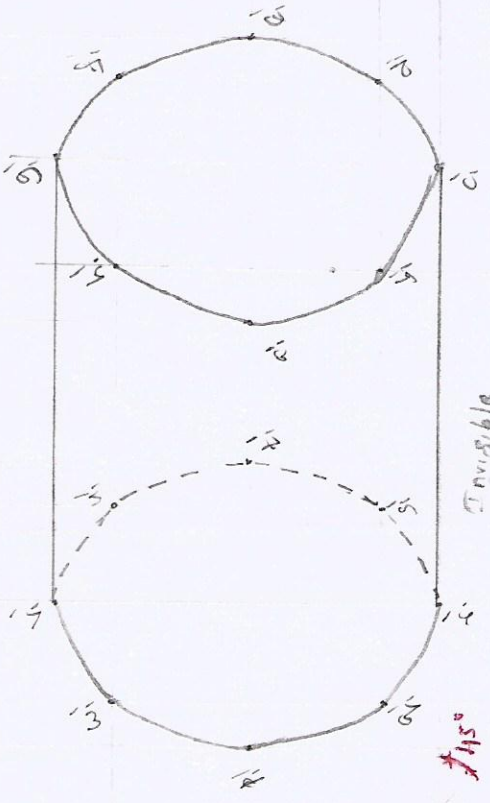

4. A cone of base diameter 40mm and axis length 65mm resting on H.P. on a point in the circumference of the base with ^{one} of its slant generators lying on the ground to the H.P. Draw its projection.

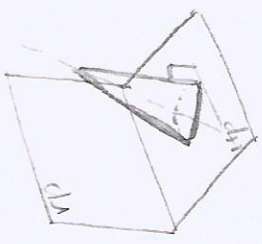

slant generator is lying on the ground

Resting on H.P. front view touches the x-line
 IR to H.P. Draw circle in H.P.

slant generator is IR to H.P.

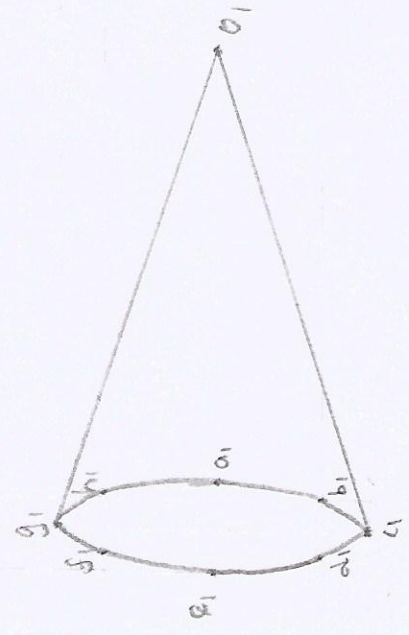
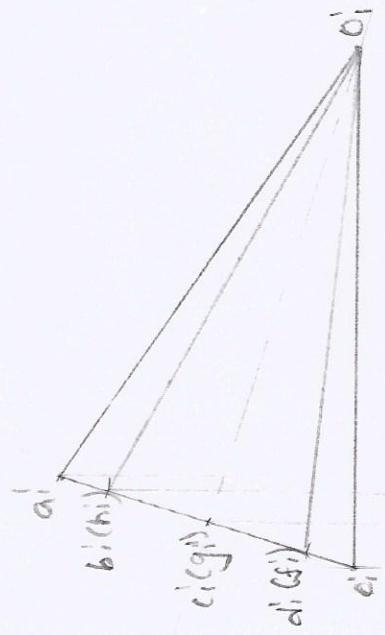
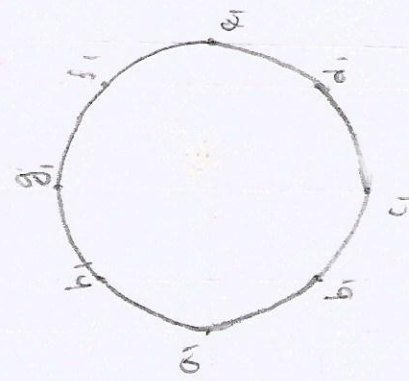
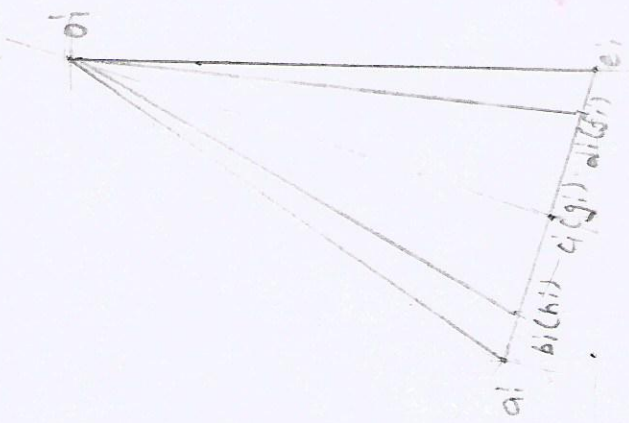
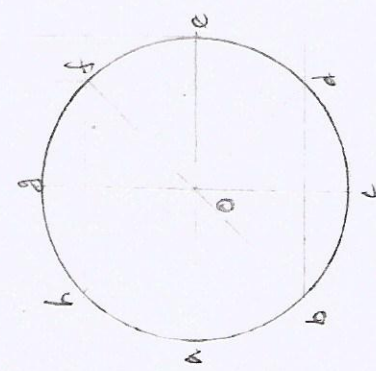
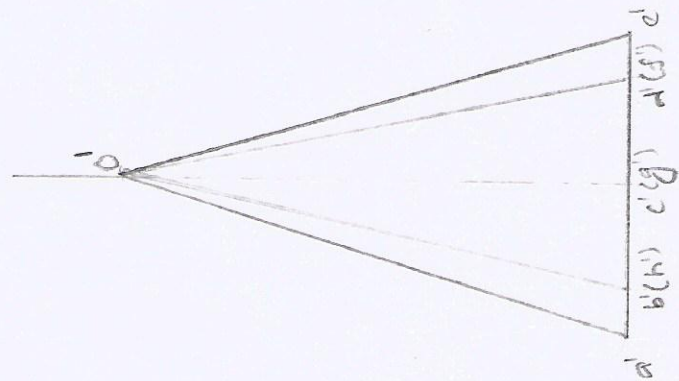

5. A cone of base diameter 40 mm and height 56 mm is freely suspended from one of its base point such that its axis is parallel to V.P. Draw its Projection.

Centre of gravity of cone = $\frac{h}{4} = \frac{56}{4} = \underline{\underline{14 \text{ mm}}}$

but 14 - axis is below

First trace, G & P in \perp line

Parallel to V.P. = Inclined to H.P. = Draw circle in H.P.

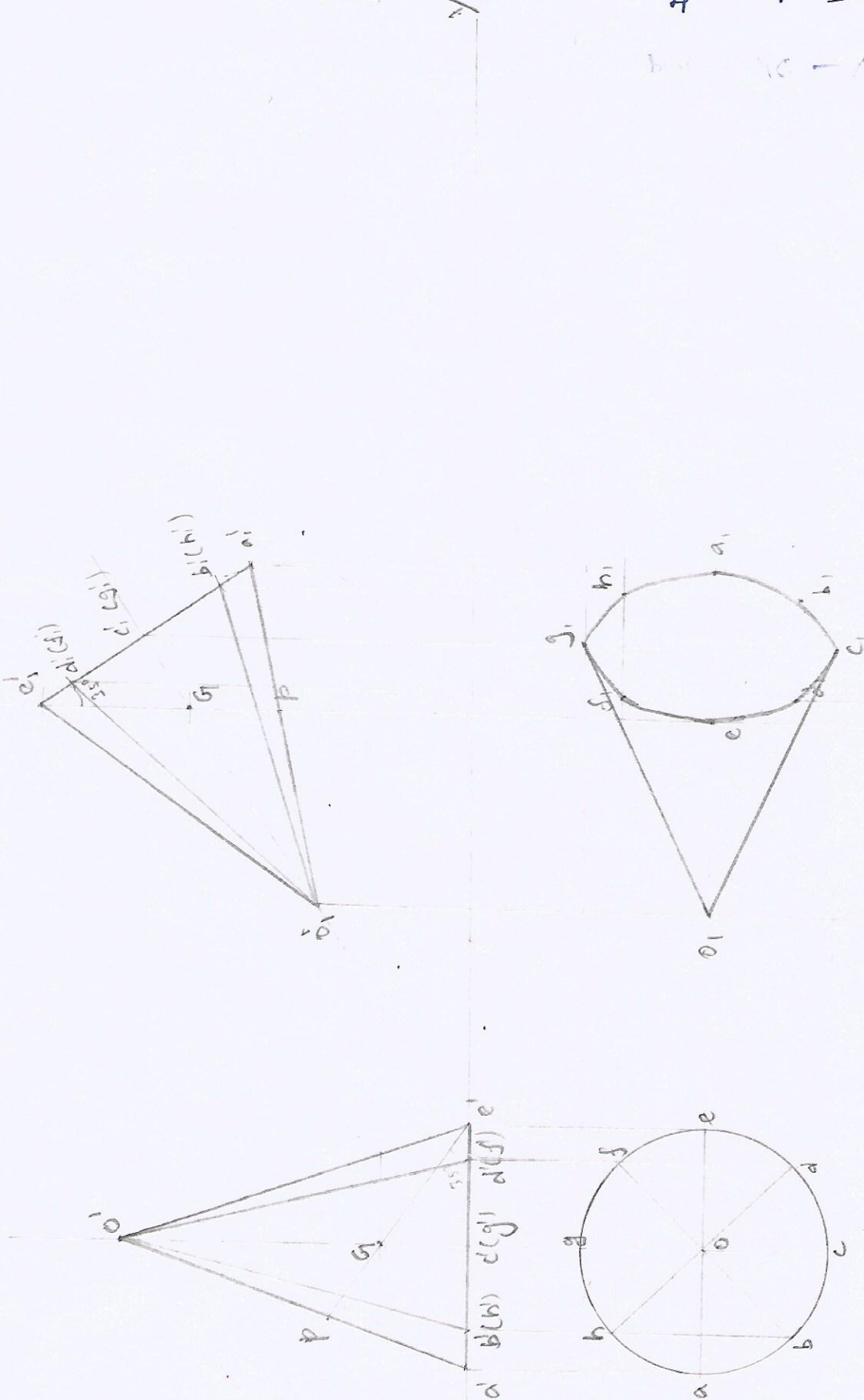

6. A Pentagonal Prism of 30mm side of base and height 80mm is resting on one of its edges of the base in such a way that the axis makes an angle of 45° with the H.P. and axis parallel to V.P. Draw its other Projections of the Prism.

Axis inclined at 45° with HP

H.W.
resting on one of its corner of the base

resting on HP

Bottom View
Side View
Above
Below

Base inclined at 45° with HP

45° with HP
Draw Pentagon in HP

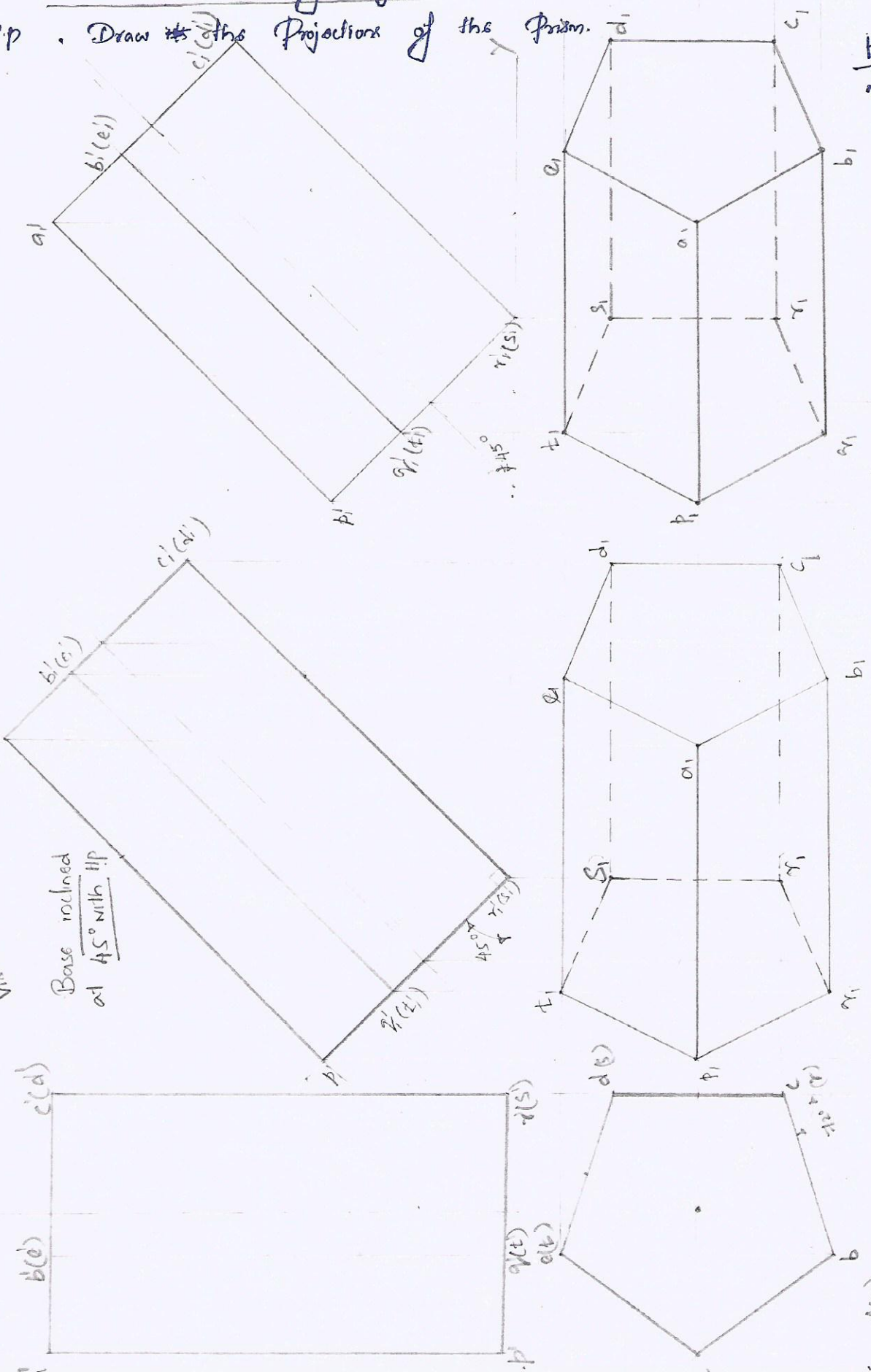

TRUE TOP VIEW

axis inclined in slope as
Pentagon shape

Q. A Pentagonal Prism of base side 30mm and axis length 55mm is lying on the ground on one of its rectangular faces with its axis inclined at 45° to V.P. Draw its front & top views.

Lying on ground:
 Front view touches the x-y line
 Inclined to VP.
 Draw the Pentagon in VP.

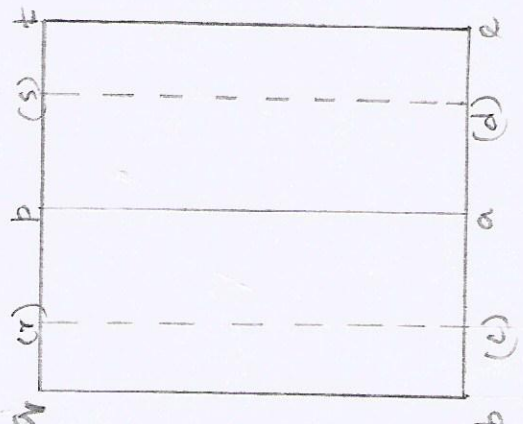
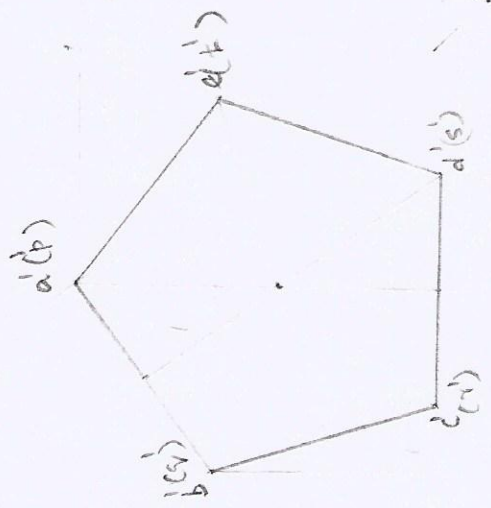
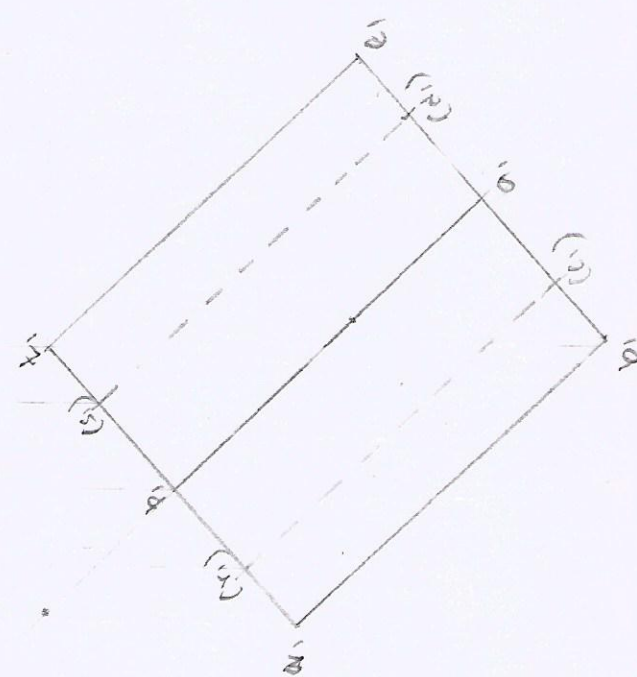
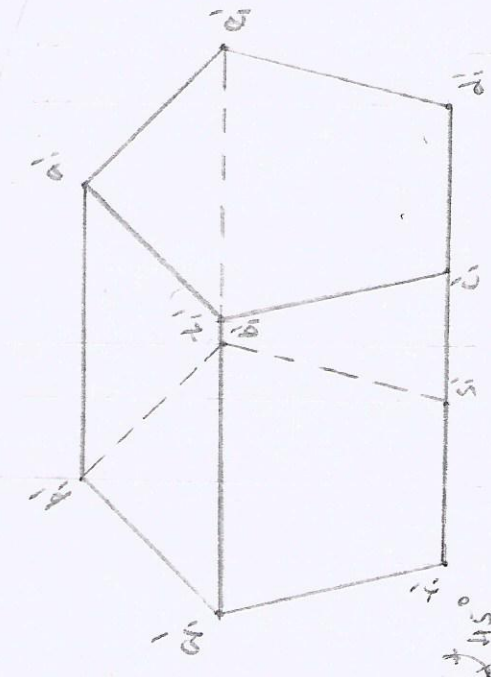
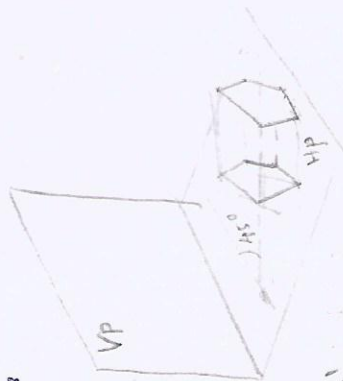

8. A hexagonal Prism of base side 35mm and axis length 65mm is lying on the ground on one of its rectangular faces with its axis inclined at 35° to v.p. Draw its Projections.

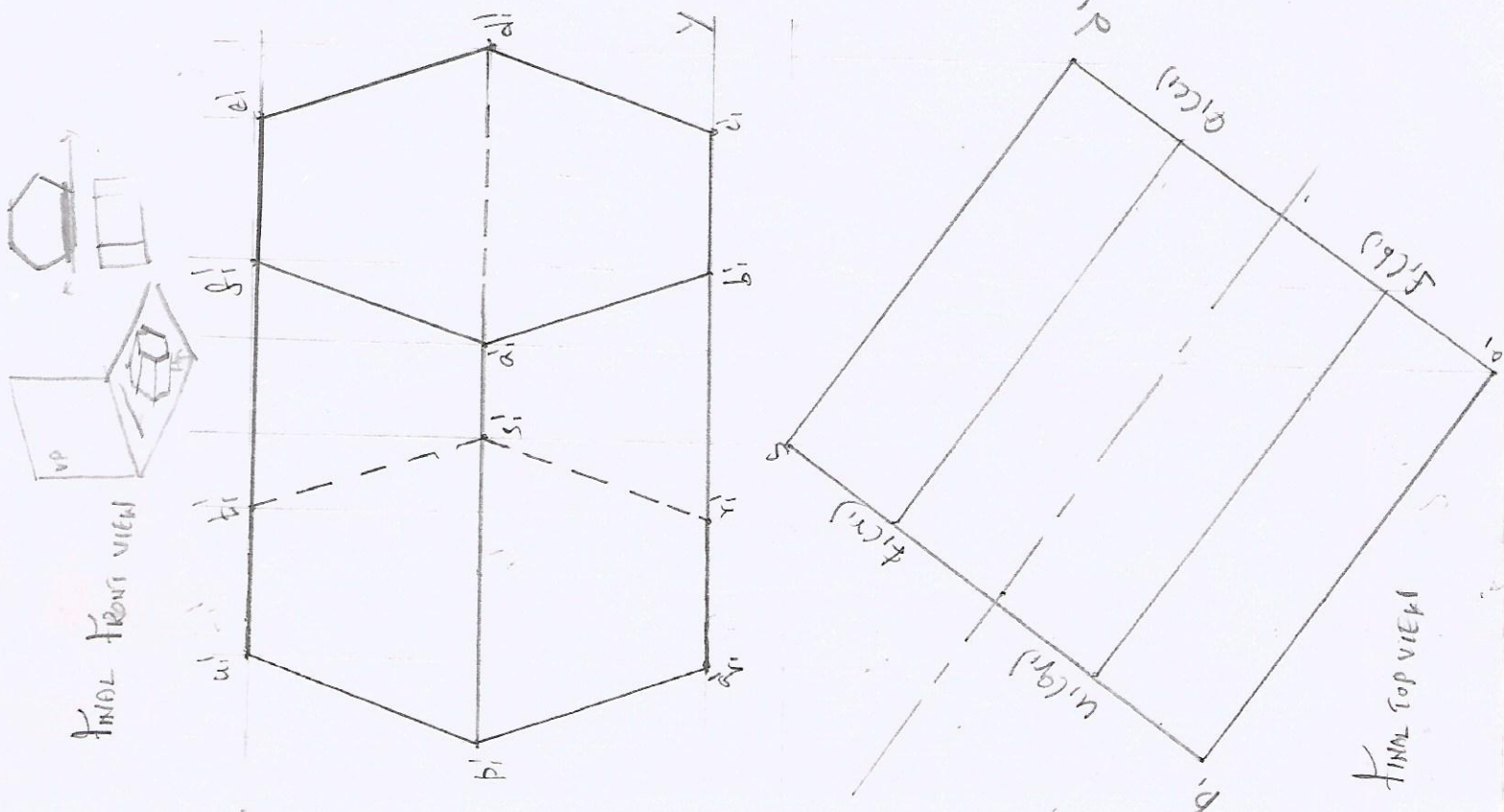

lying on ground... front view touches the x-y line
 inclined to v.p. Draw the projections in v.p.

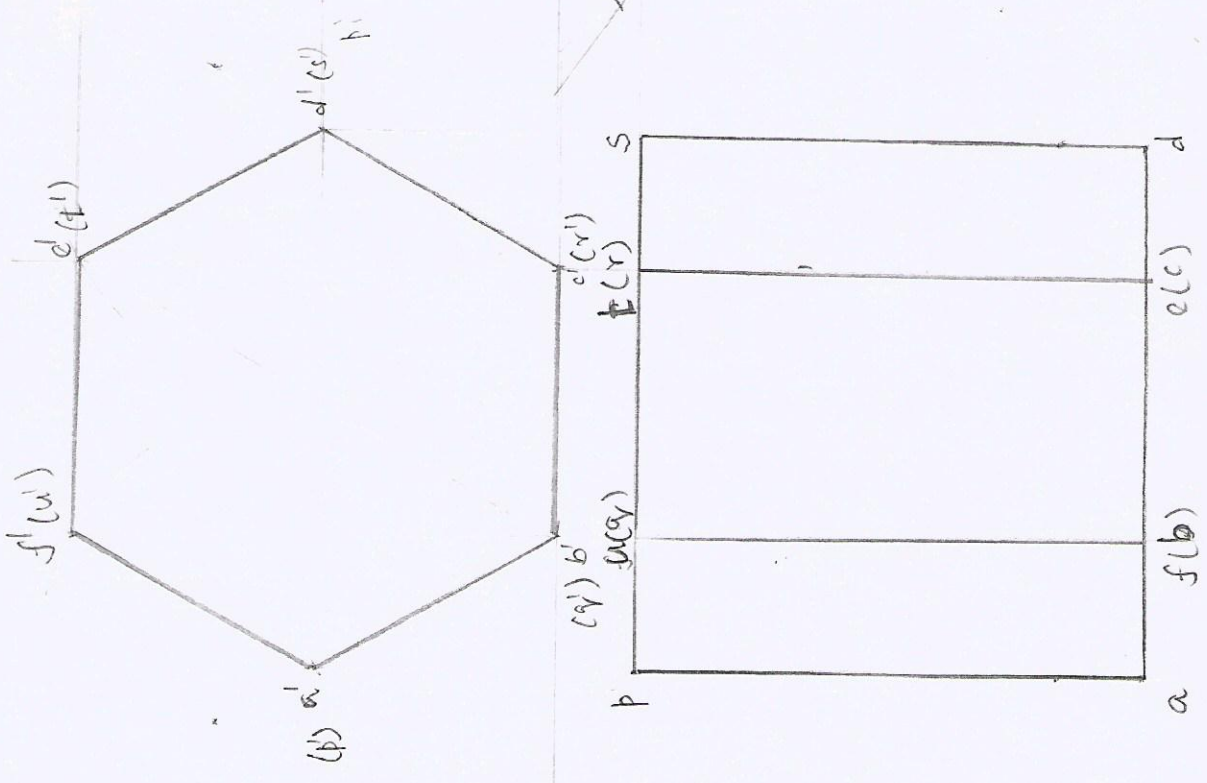

9. A hexagonal Prism of base side 35mm and axis height 65mm is lying on the ground on one of its longer edges with its axis inclined at 35° to the v.p. Draw its Projection.

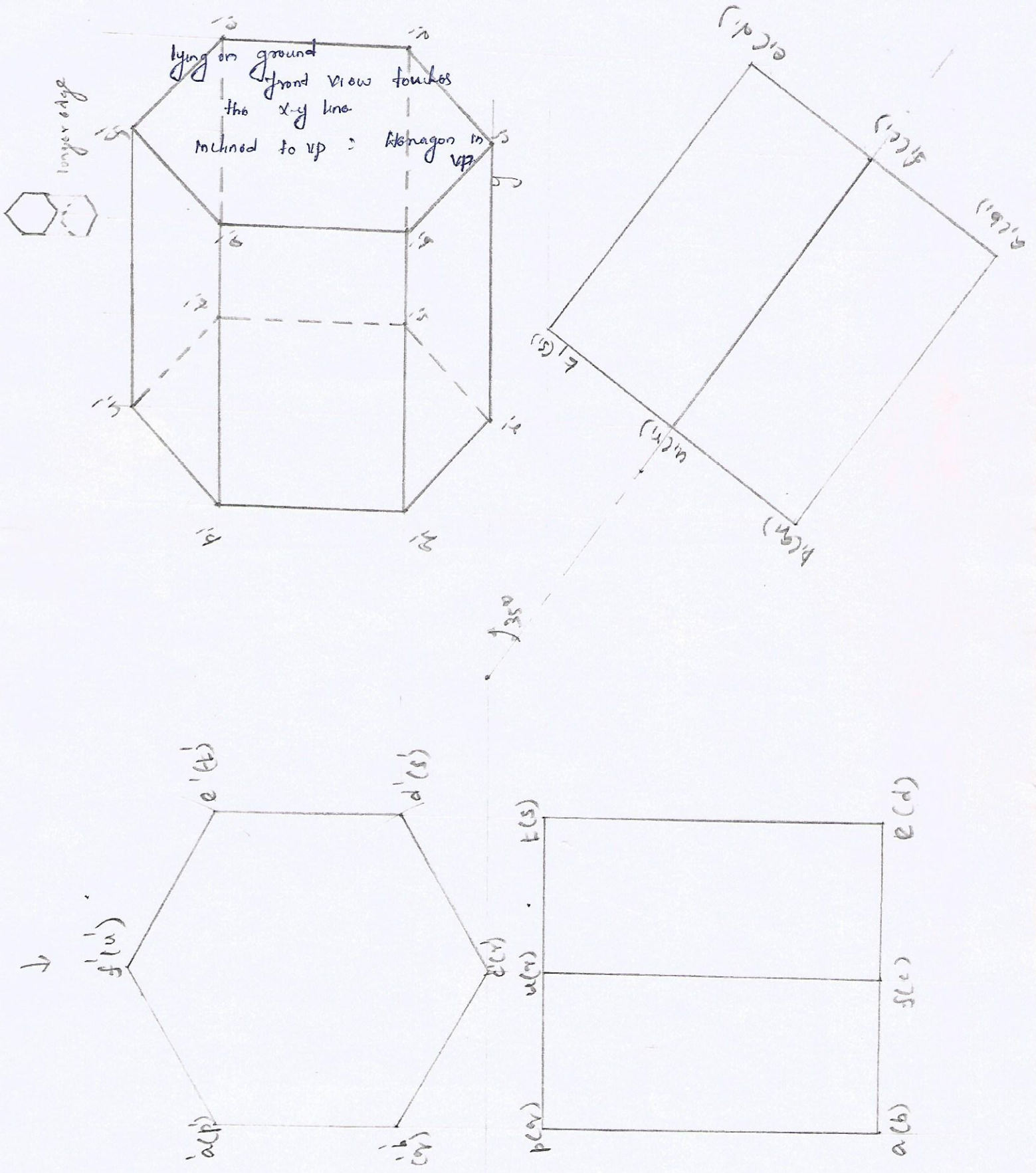

10. A Pentagonal Prism of base side 30 mm and axis height 60 mm is lying on the ground on one of its longer edges with its axis inclined at 30° to v.p. Draw its projection.

lying on ground

\therefore front view touches the x-y line

Inclined at 30° to xp

\therefore pentagon in vp.

Final Front View

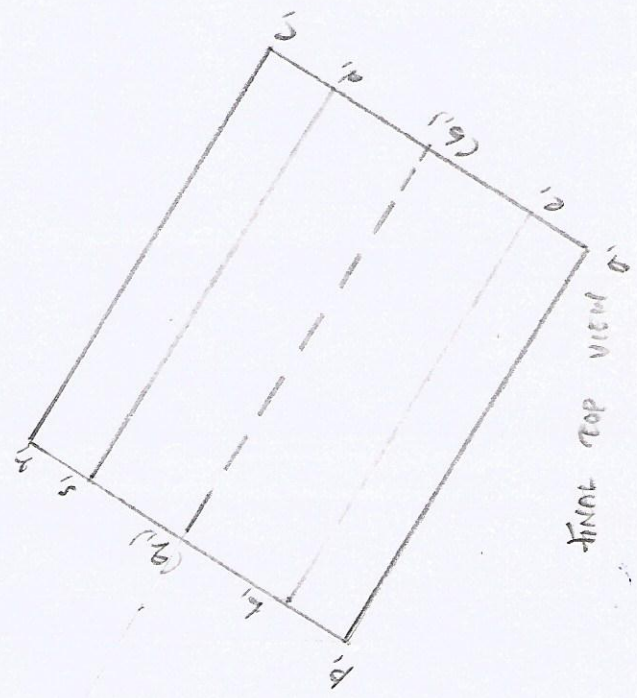
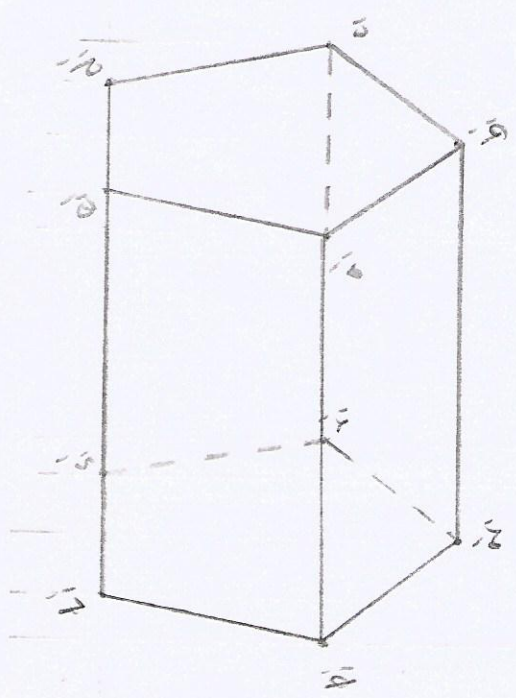

Final Top View

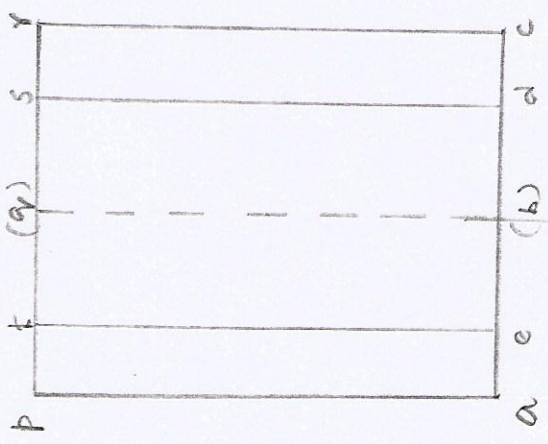
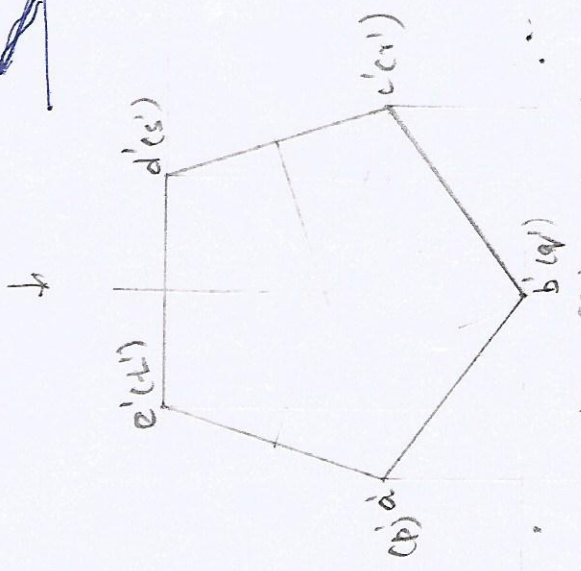

11. A Pentagonal pyramid of base edge 25 mm and axis length 60 mm resting on one of ~~its~~ the base edges on H.P., such that the highest base corner is 20 mm above the H.P. Draw its Projection.

resting on H.P.

∴ Front view touches the xy line

20 mm above H.P.

∴ Draw the pentagon in H.P.

Edge resting: Edge in right side.

FRONT VIEW

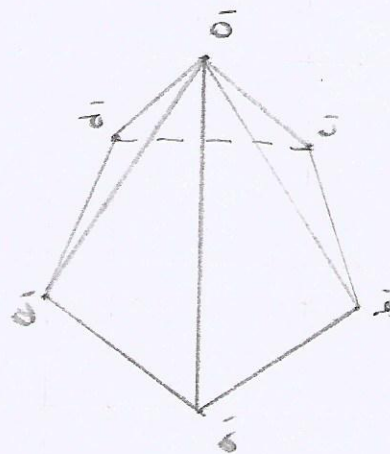
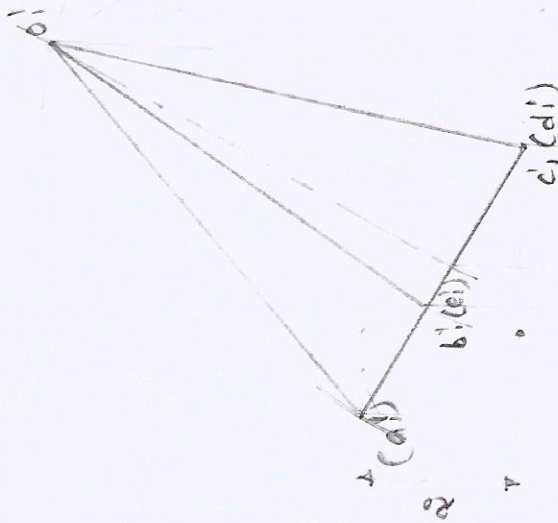

TOP VIEW

Edge resting ∴ Edge in right side

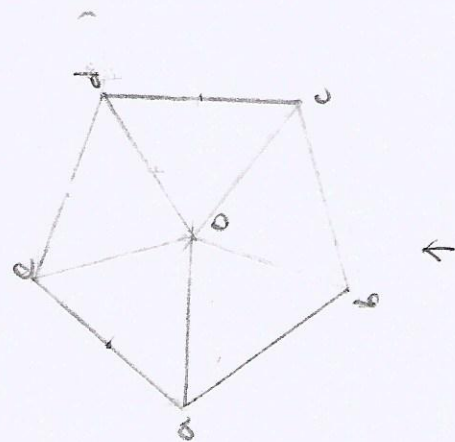
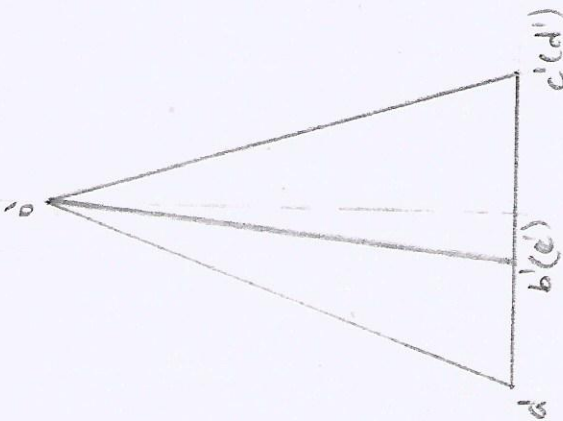

12. A Pentagonal Pyramid of base side 35mm and axis height 60mm is resting on Hp on ~~one of its base corner~~ ^{ii (a point with its slant edge is \perp to Hp)} with its axis inclined at 35° to Hp. Draw its projection.

rest on Hp: front view touches the x-y line
 inclined to Hp: Pentagon in Hp.
 inclined line in VP.

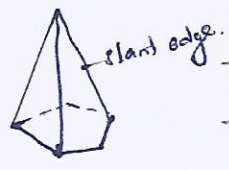

Axis inclined at 35° to HP.

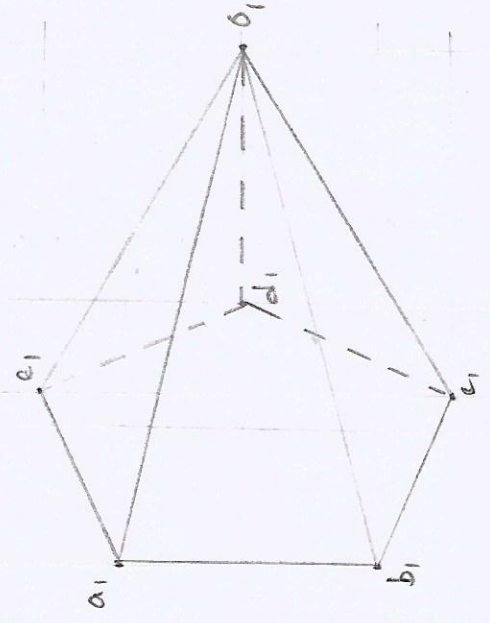
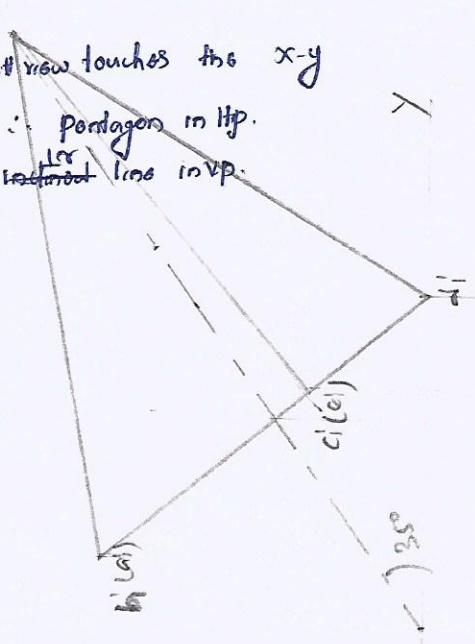

Slant edge \perp to HP

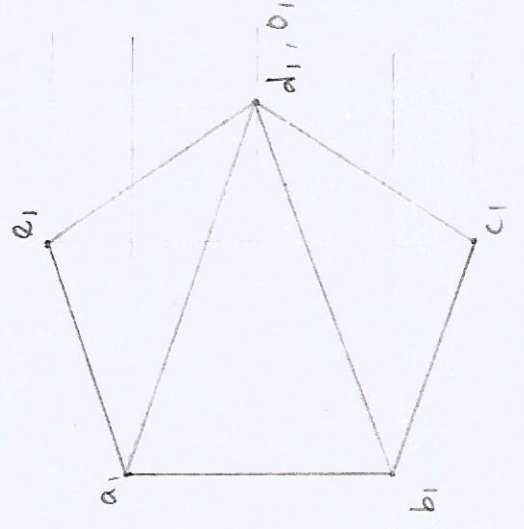
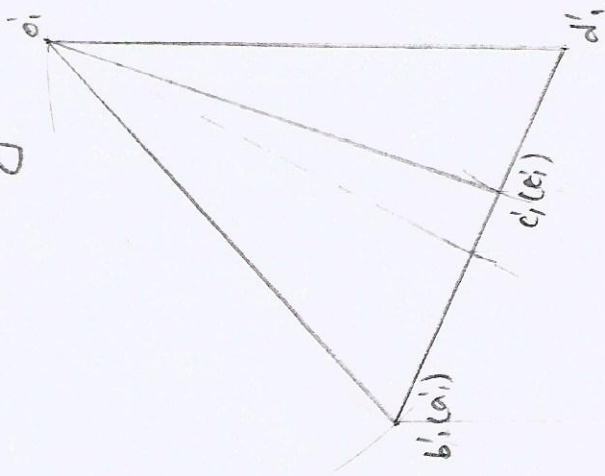

resting on a point in VP
 as per the condition

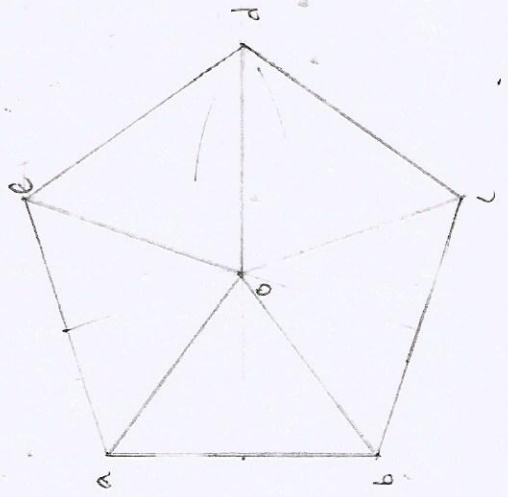
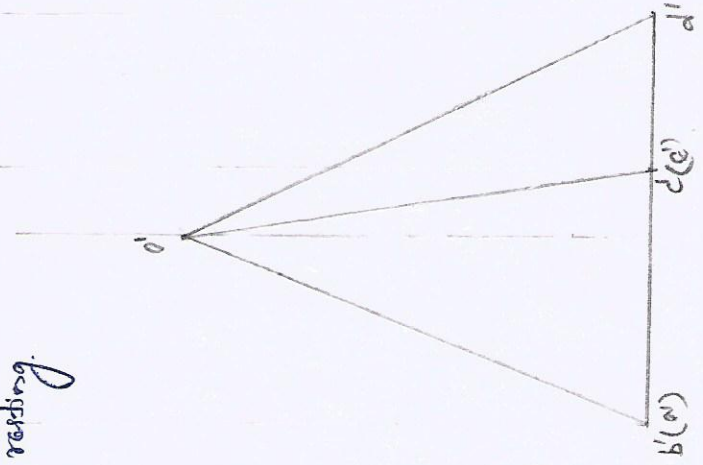

resting on

13. A Pentagonal Pyramid, side of base 30mm and axis 50mm, lying with one of its triangular faces on H.P. and \perp to both V.P & H.P. Draw its projection.

lying on H.P. : front view touches the x-y line
 \perp to H.P. : Pentagon in H.P.

Triangular face resting in side in right side
 or
 edge

Triangular face \perp to H.P.

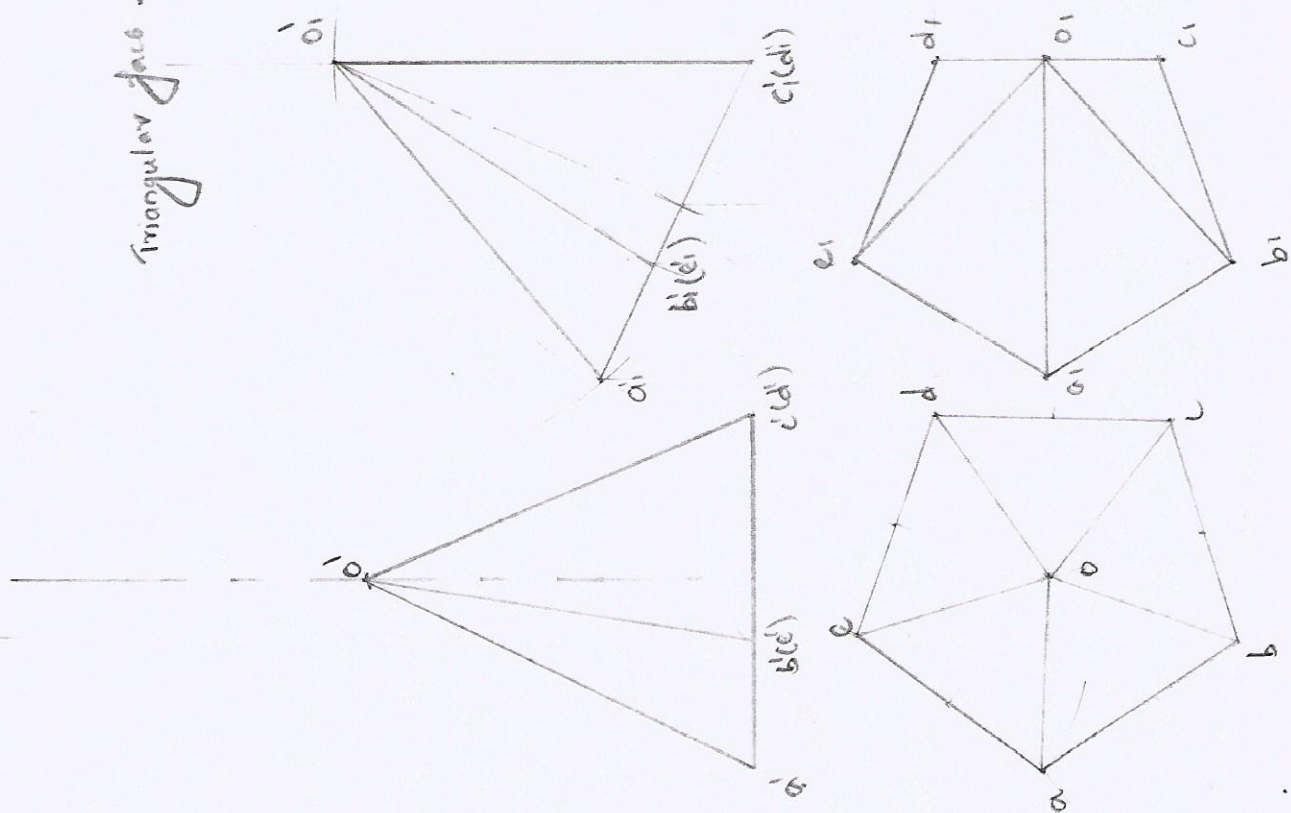

14. A hexagonal Pyramid of base edge 25mm and axis height 60mm with its apex just touches the H.P. Draw its Projection.

Freely suspended with apex touches the H.P.

Freely suspended with one corner touching the H.P.

Suspended by its base corner. ∴ corner in right side

$$60 = \frac{60}{H}$$

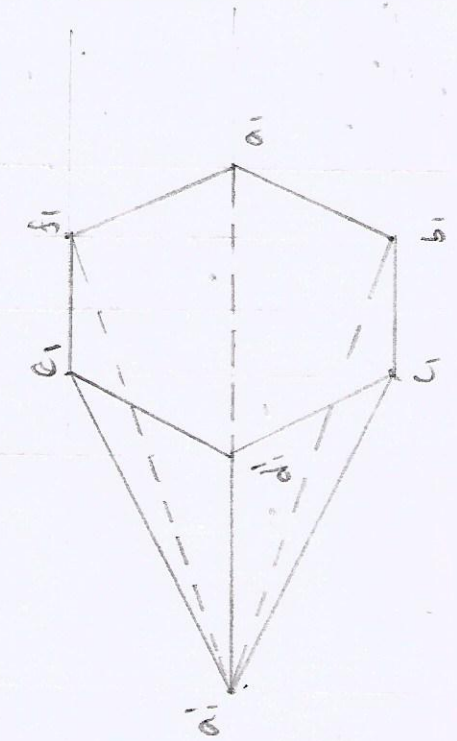
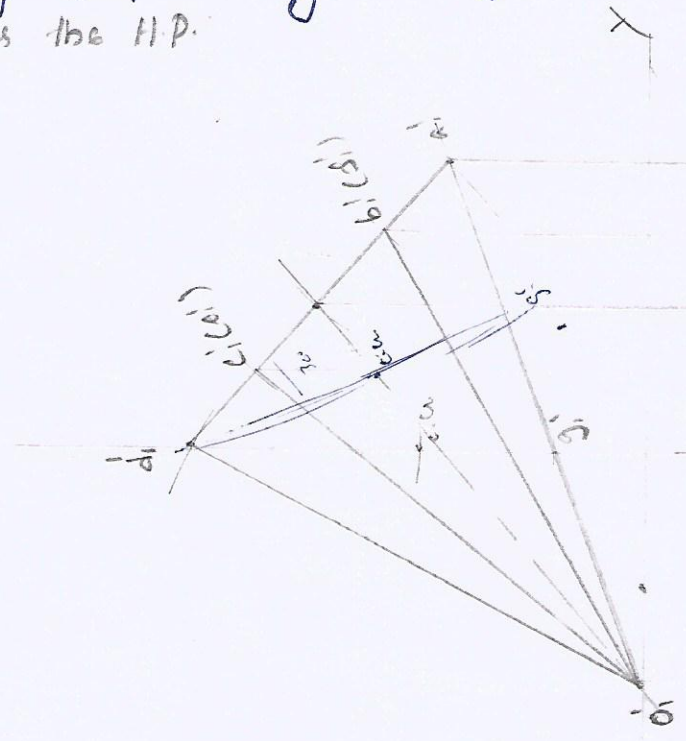
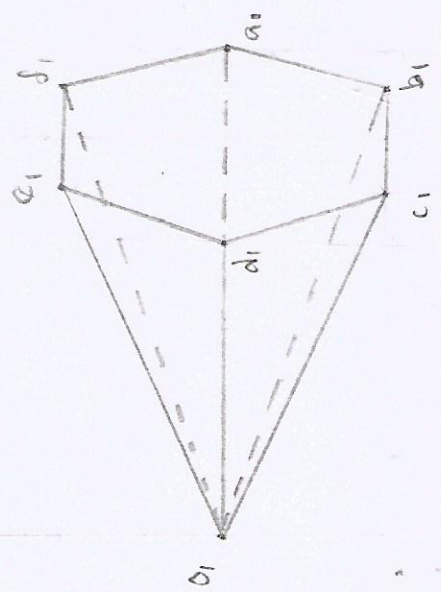
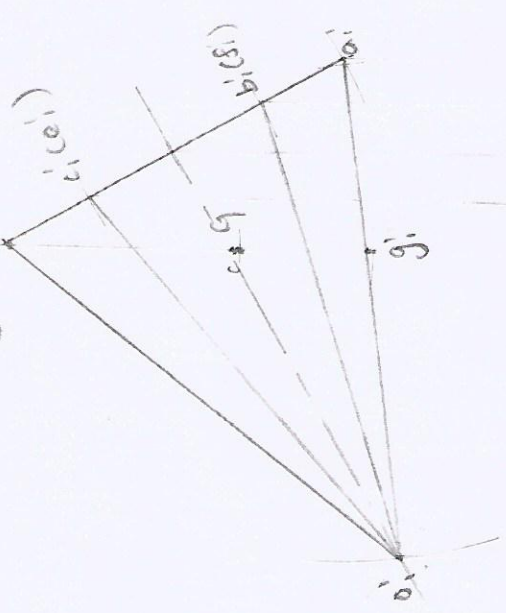
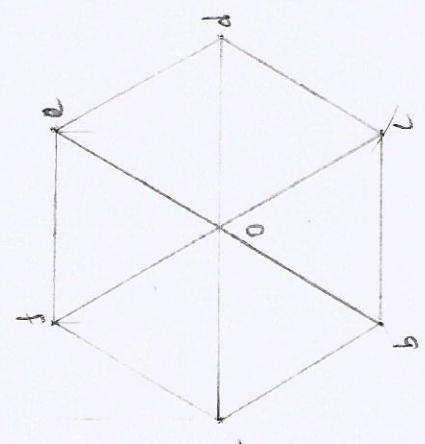
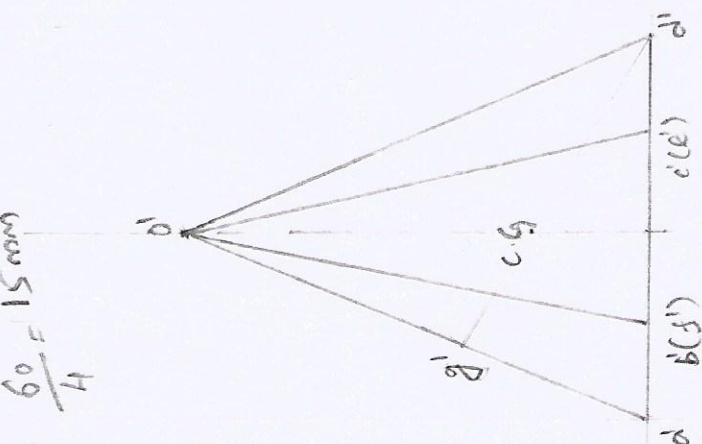

15. A hexagonal Pyramid of base side 30mm and altitude 45mm rests on the HP on one of its base edges such that the triangular face containing the resting edge is \perp to both the HP & VP. Draw its Projections.

rest on HP:

\therefore front view touches the x-y line
 Triangular face is \perp to HP & VP.
 Hexagon in HP

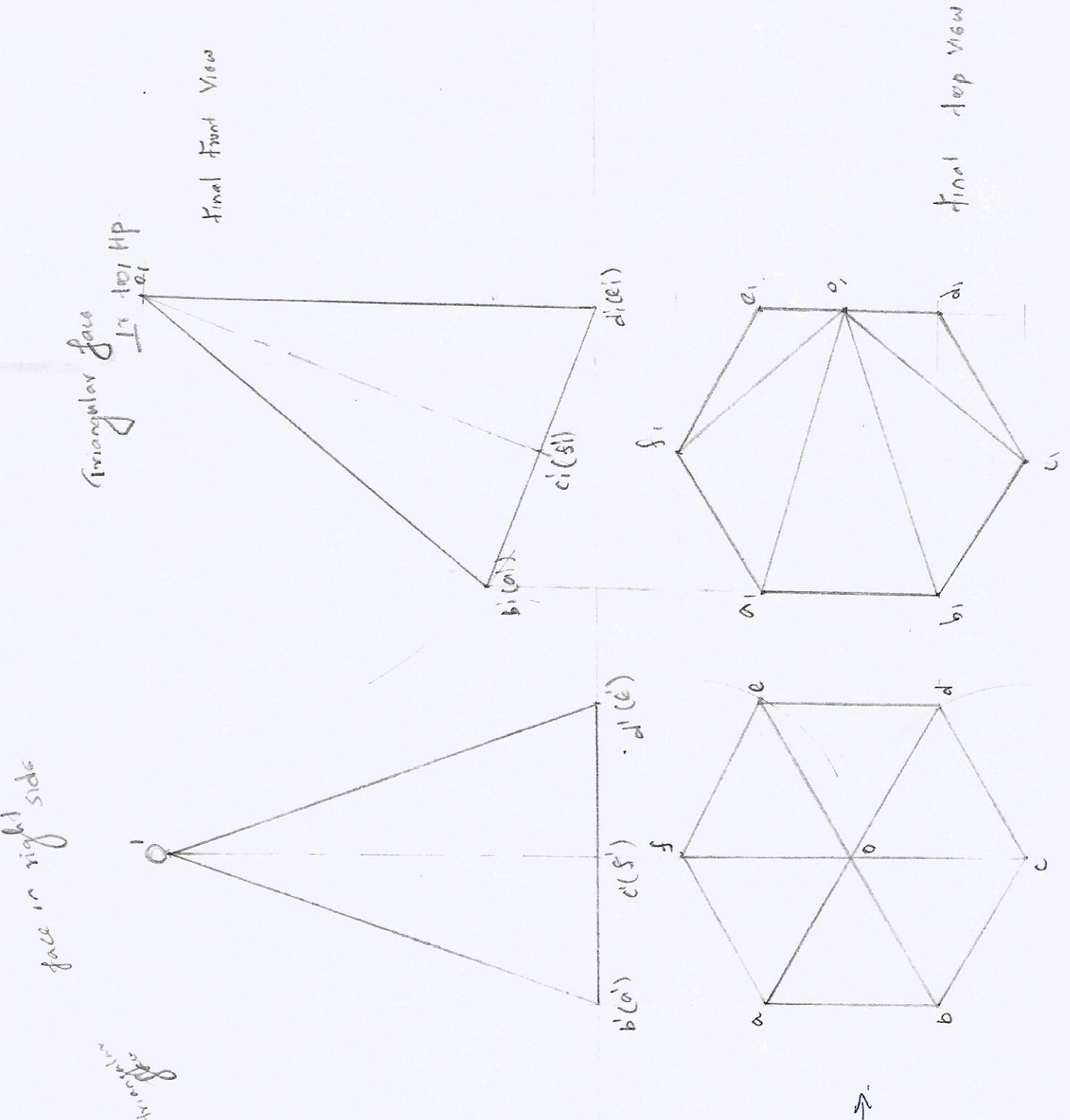

16. A hexagonal pyramid of base edge 40 mm and altitude 60 mm rests on one of its base edges on the HP. With its axis inclined at 30° to the HP and parallel to the VP. Draw its top and front views.

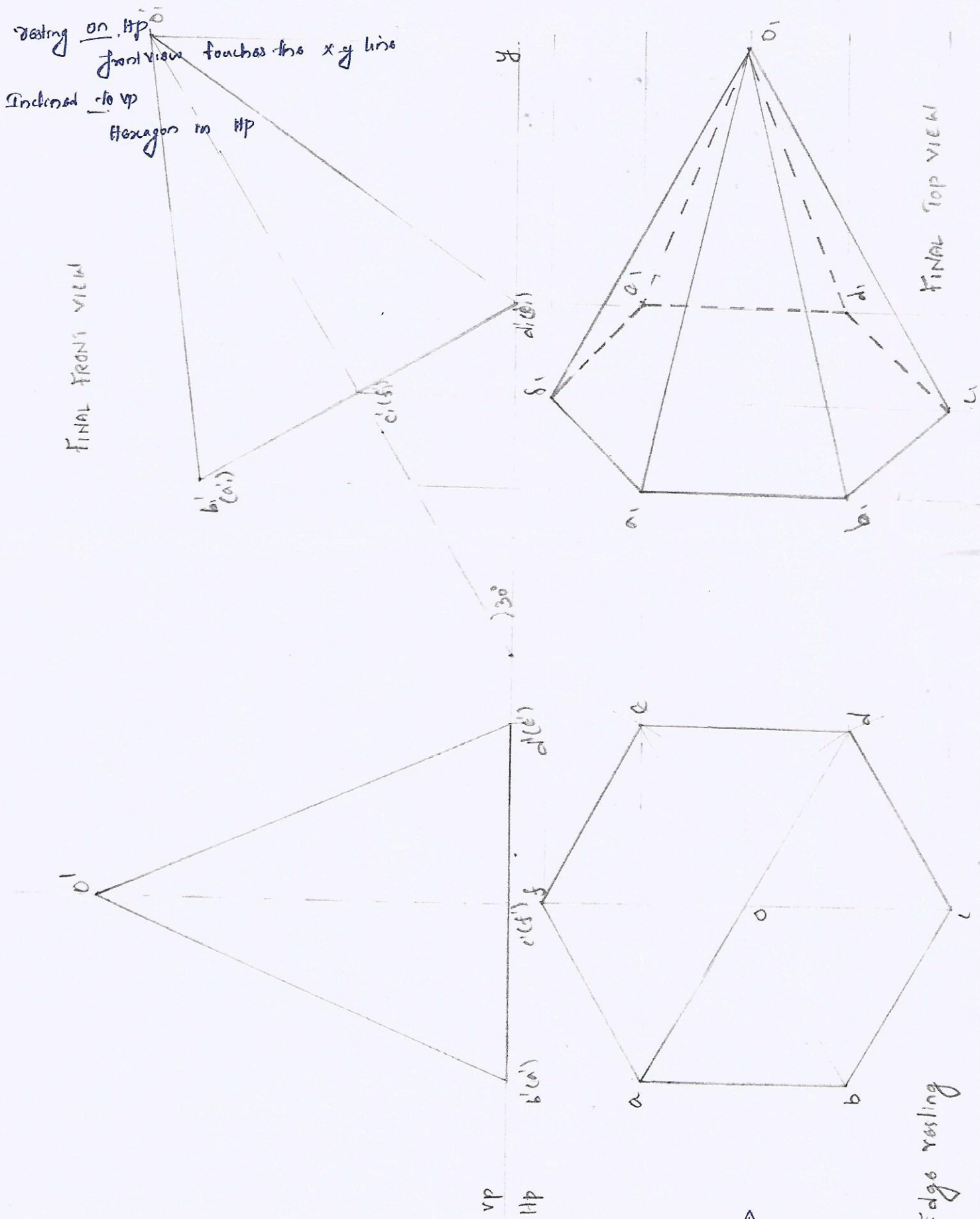

17. A hexagonal Prism of base side 25mm and axis height 60mm is resting on one of its base corners on HP. with its Solid diagonal is Vertical (\perp to HP).

resting on HP
 \therefore front view touches the x-y line
 \perp to HP
 \therefore hexagon in HP.

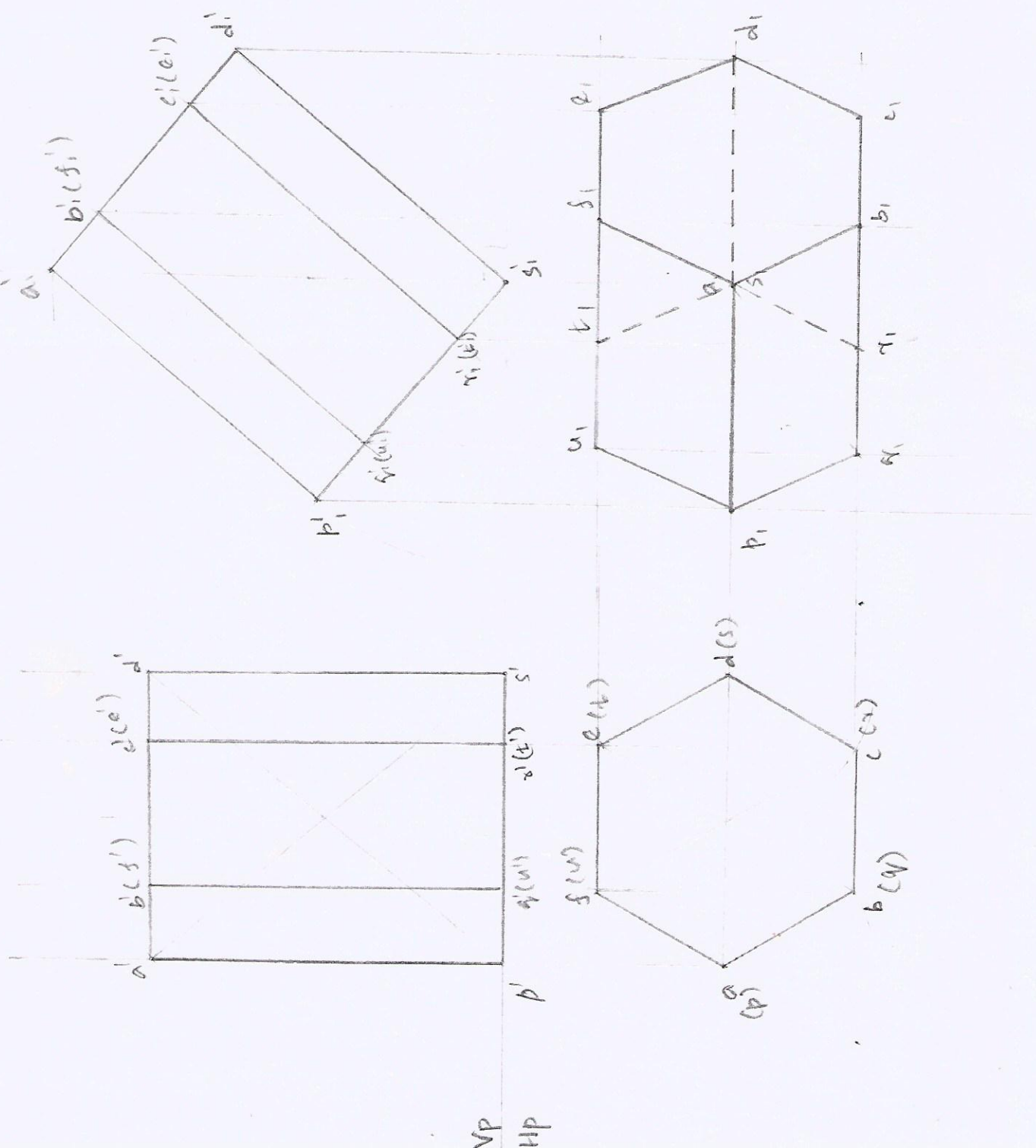

18. A square pyramid of base side 40 mm and altitude 70 mm lies on the HP on one of its triangular faces. Draw the Projections of the Pyramid.

Lying on HP
 \therefore front view touches the X-Y line
 & Square in HP

Triangular face on HP
 \therefore side is right angle
 Triangular face

Triangular face lying on HP

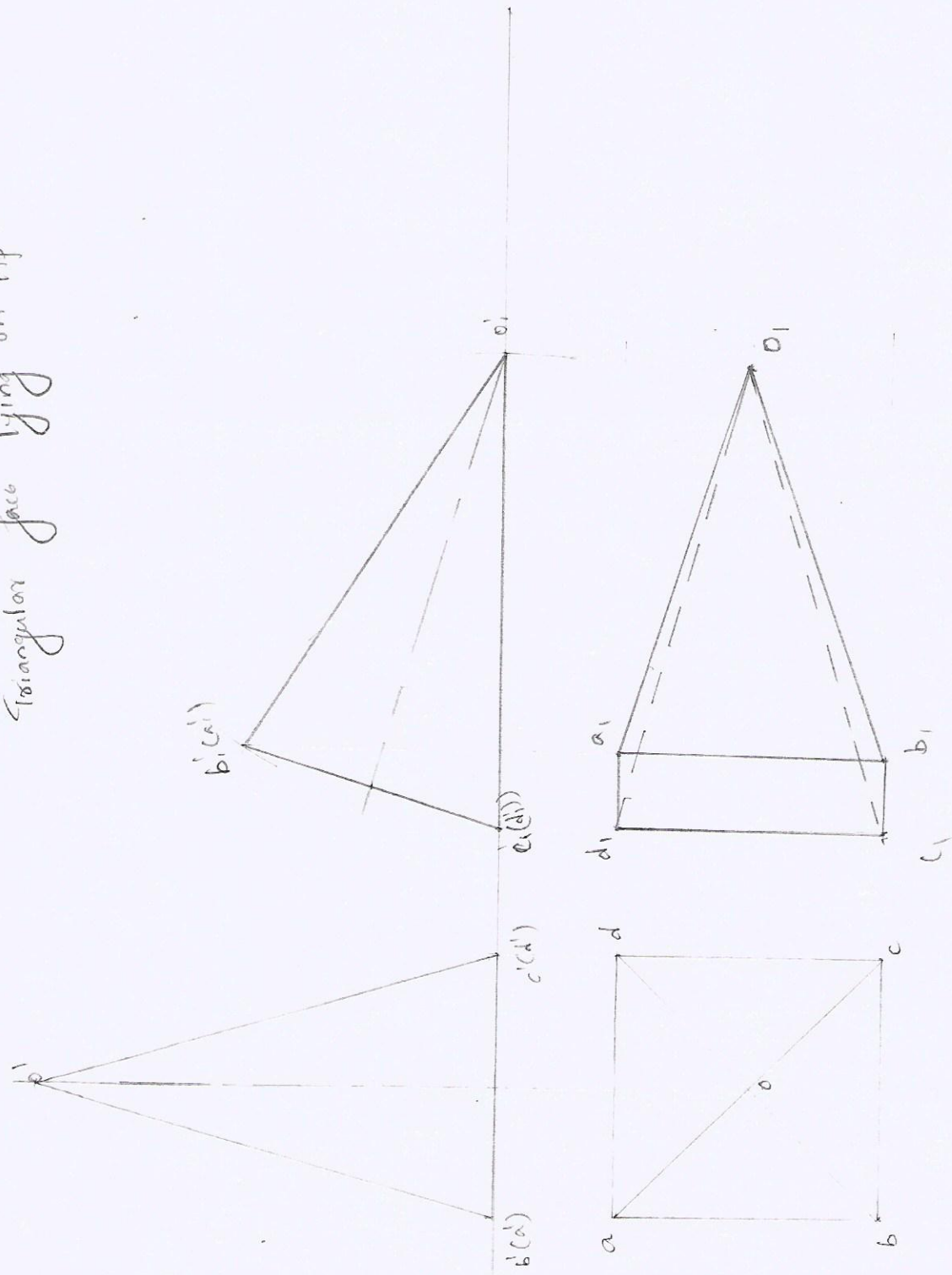

19. A cylinder of base diameter 45mm and axis height 55mm is resting on one of its point on the circumference of the base on H.P. with its solid diagonal \perp Vertical or \perp to H.P.

resting on H.P.
 \therefore G.V touch the X-Y
 \perp to H.P.
 \therefore Circle in H.P.

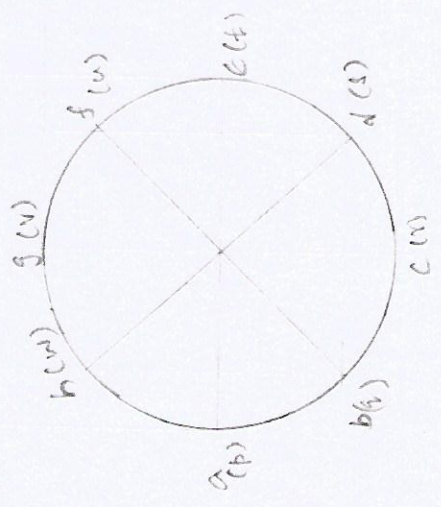
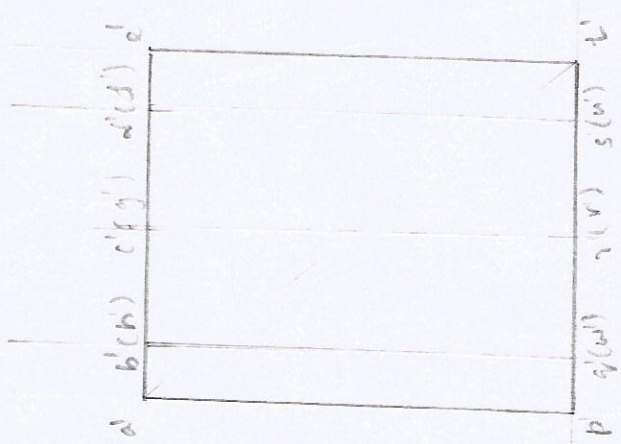
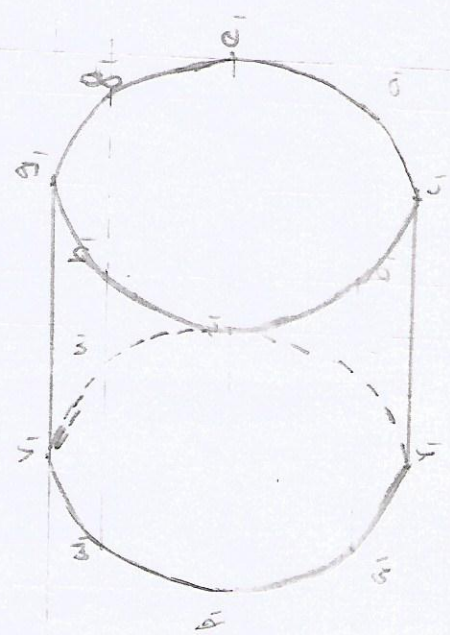
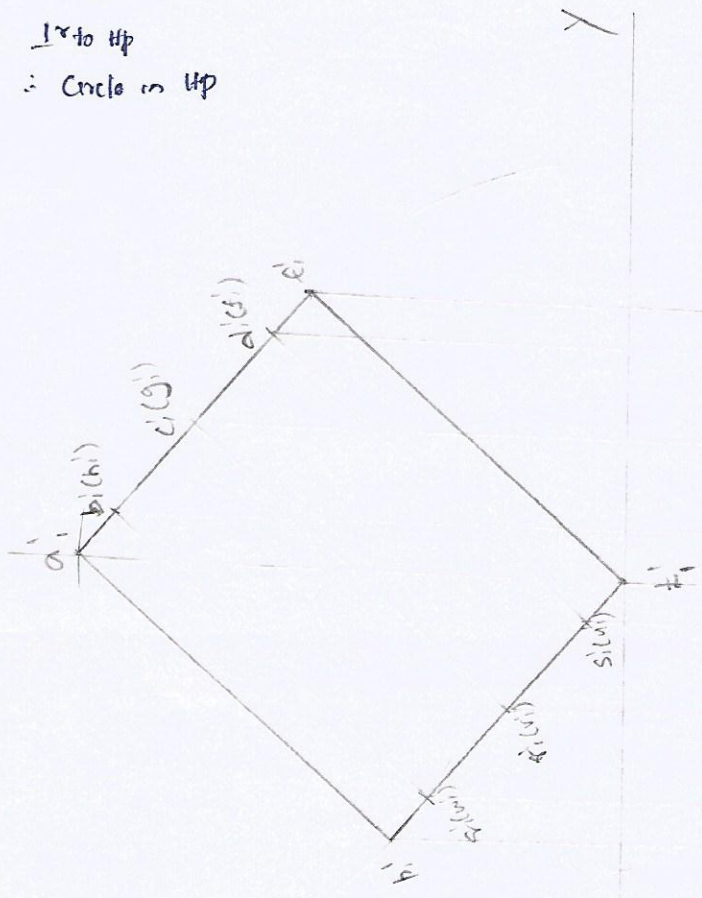
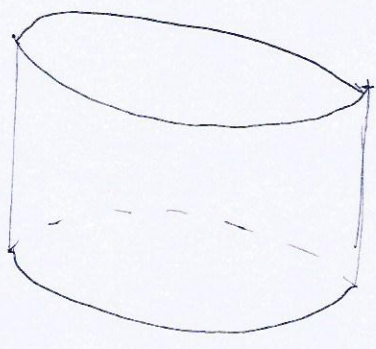

VP
 HP

20. Draw the Projection of a cube of 45 mm side resting on one of its corners in the H.P. with a solid diagonal in the H.P.

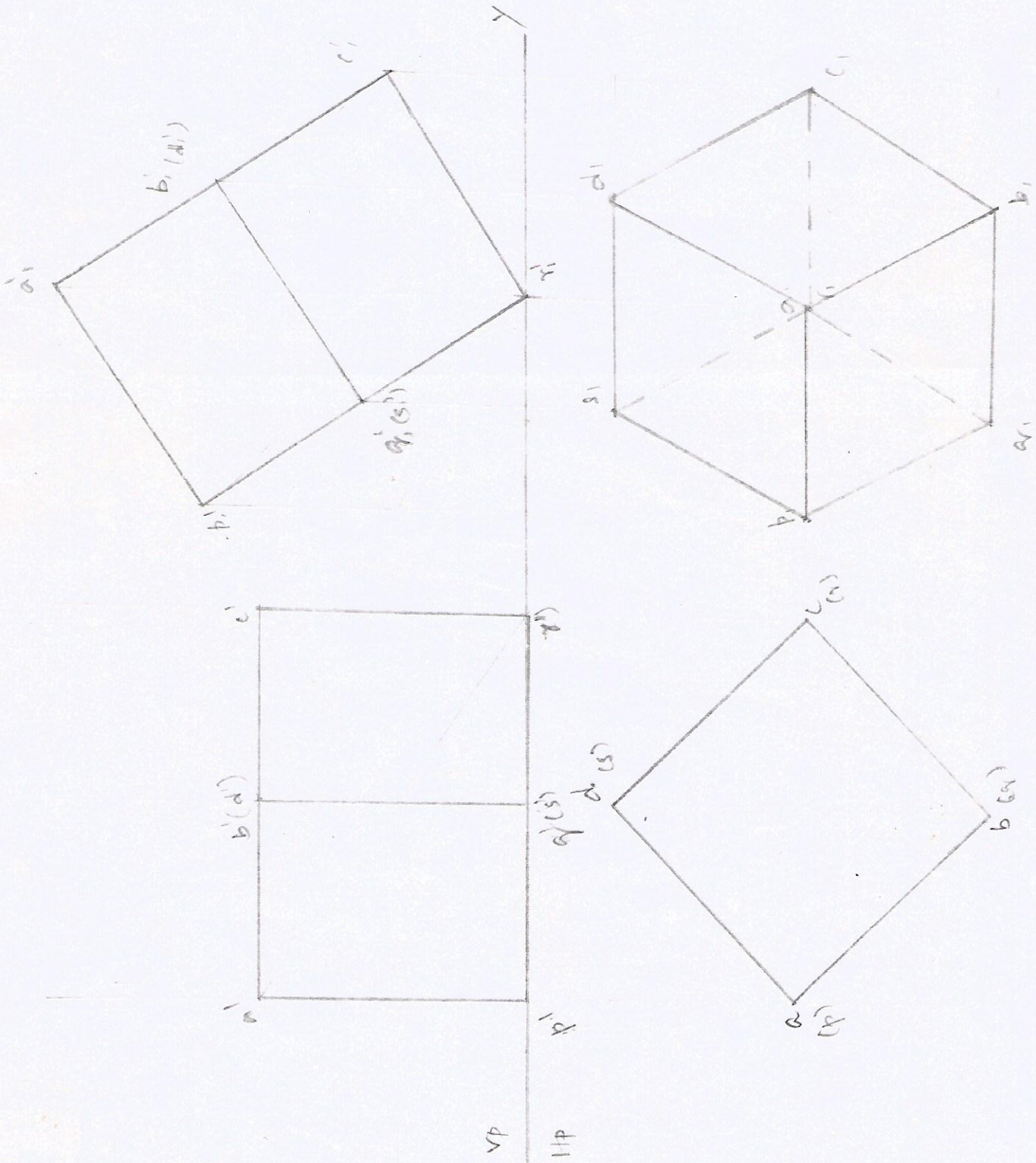

Unit - W

(31)

Sections of Solids

i. A cube of side 30mm rests on the HP on its end with the vertical faces equally inclined to the VP. It is cut by a plane perpendicular to the VP and inclined at 30° to the HP meeting the axis at 25mm above the base. Draw its front view, sectional top view and the true shape of the section.

rest on HP : f.v touches the x-y line

equally inclined to VP.

$\therefore 45^\circ$ to VP Draw 45° in HP

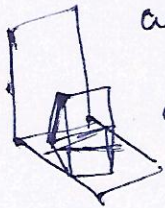

Cutting plane 30° to HP.

inclination in VP

Cutting plane meeting the axis

at 25mm above the base.

TRUE SHAPE OF SECTION

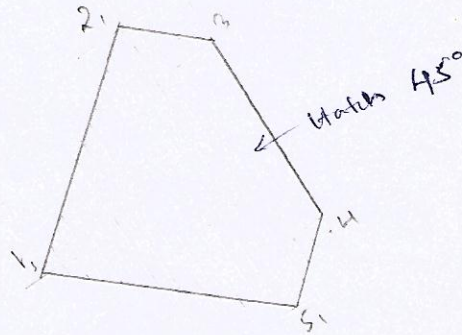

- a' - p' - 1
- b' - q' - 2
- c' - b' - 3
- c' - d' - 4
- (s') - (d') - 5

Total points - 5

x VP
y HP

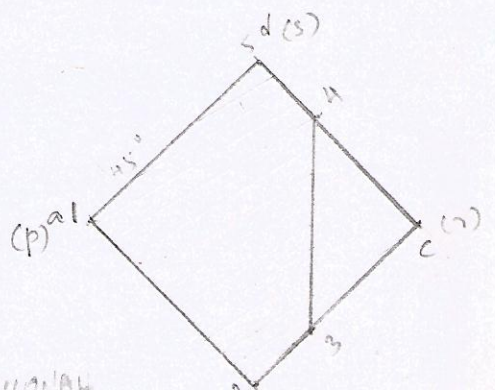
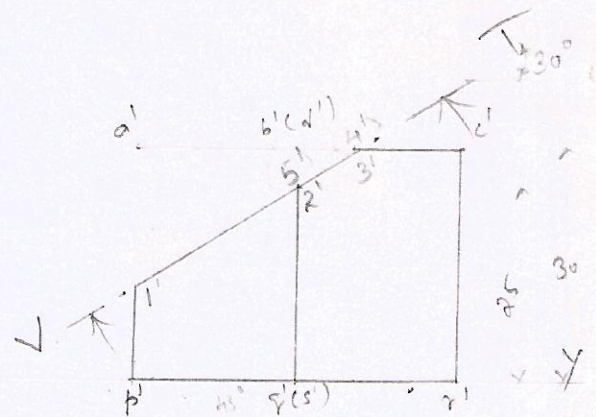

Matches 45°

2. A cube of side 25 mm rests on the Hp. one of its faces with a vertical face inclined at 35° to the Vp. It is cut by a plane perpendicular to the Vp and inclined at 35° to the Hp and meeting the axis at 20 mm above the Hp. Draw the front view, Sectional top view and the true shape of the section.

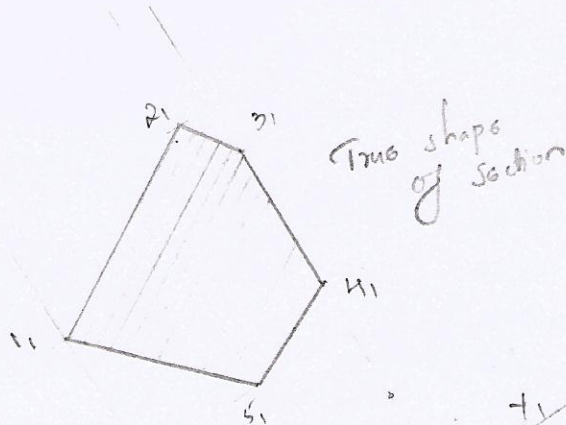
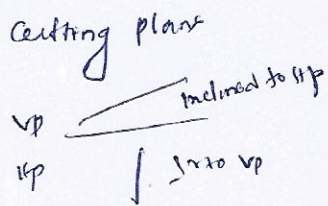

$a'-b'-c'-d'-e'$
 $b'-g'-2'$
 $c'-b'-3'$
 $c'-d'-4'$
 $d'-s'-5'$ (invisible)

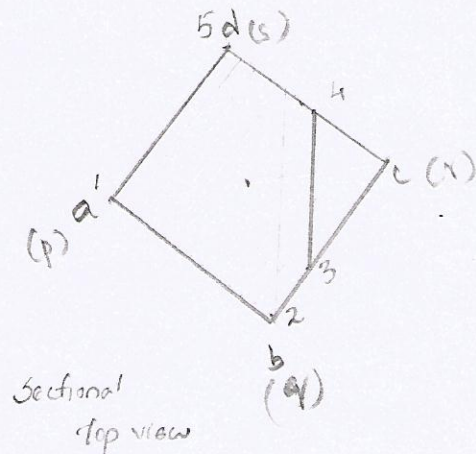
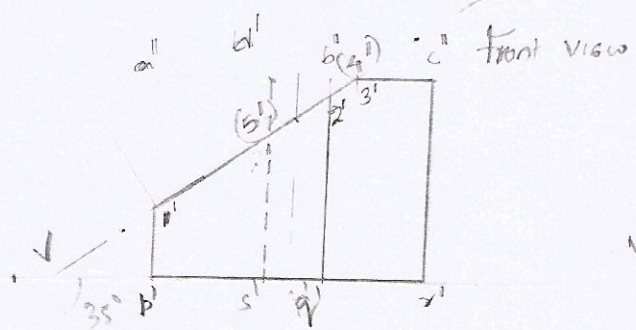

Sections of Solids

3. A cube of side 25 mm rests on the HP on one of its faces with a vertical face inclined at 35° to the VP. A plane perpendicular to the HP and inclined at 50° to the VP cuts the cube, 3 mm away from the axis. Draw the top view and the sectional front view. Also draw the true shape of the section.



rest on HP
 ∴ front view touches xy-line

face inclined to VP
 Square in HP

cutting plane inclined at 50° to VP
 ∴ cutting plane in HP.

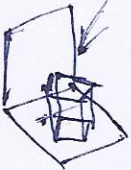

sectional front view

Draw an arc of radius 3mm from o
 Draw a tangent to the arc at 50°

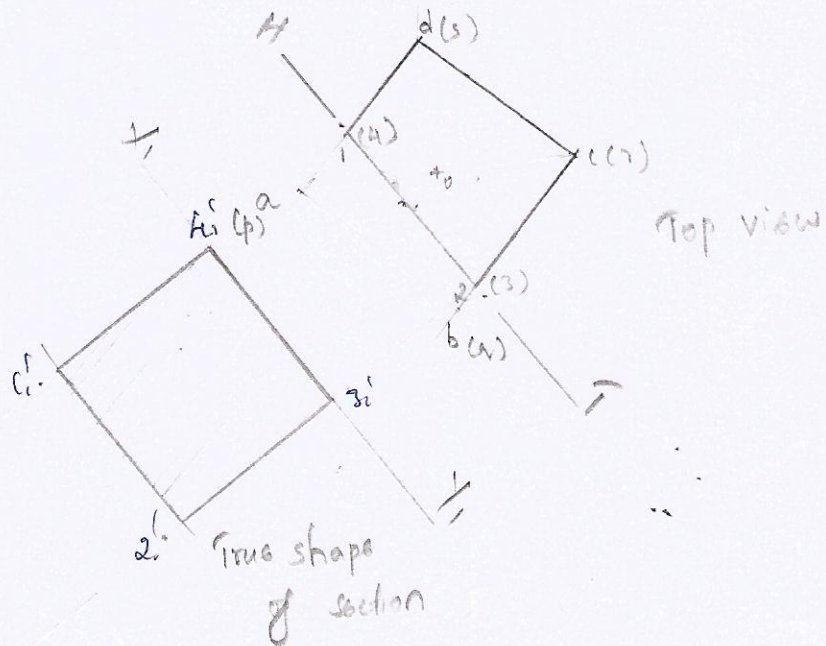
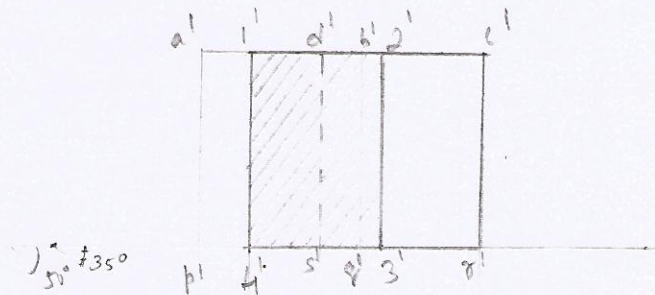

A. A cube of side 40mm is placed and cut by a plane in such a way that the true shape of the section is a regular hexagon. Draw the front and top views of the cube and determine the inclination of the plane with the HP.

Draw a face at 45° in HP

True shape of section.

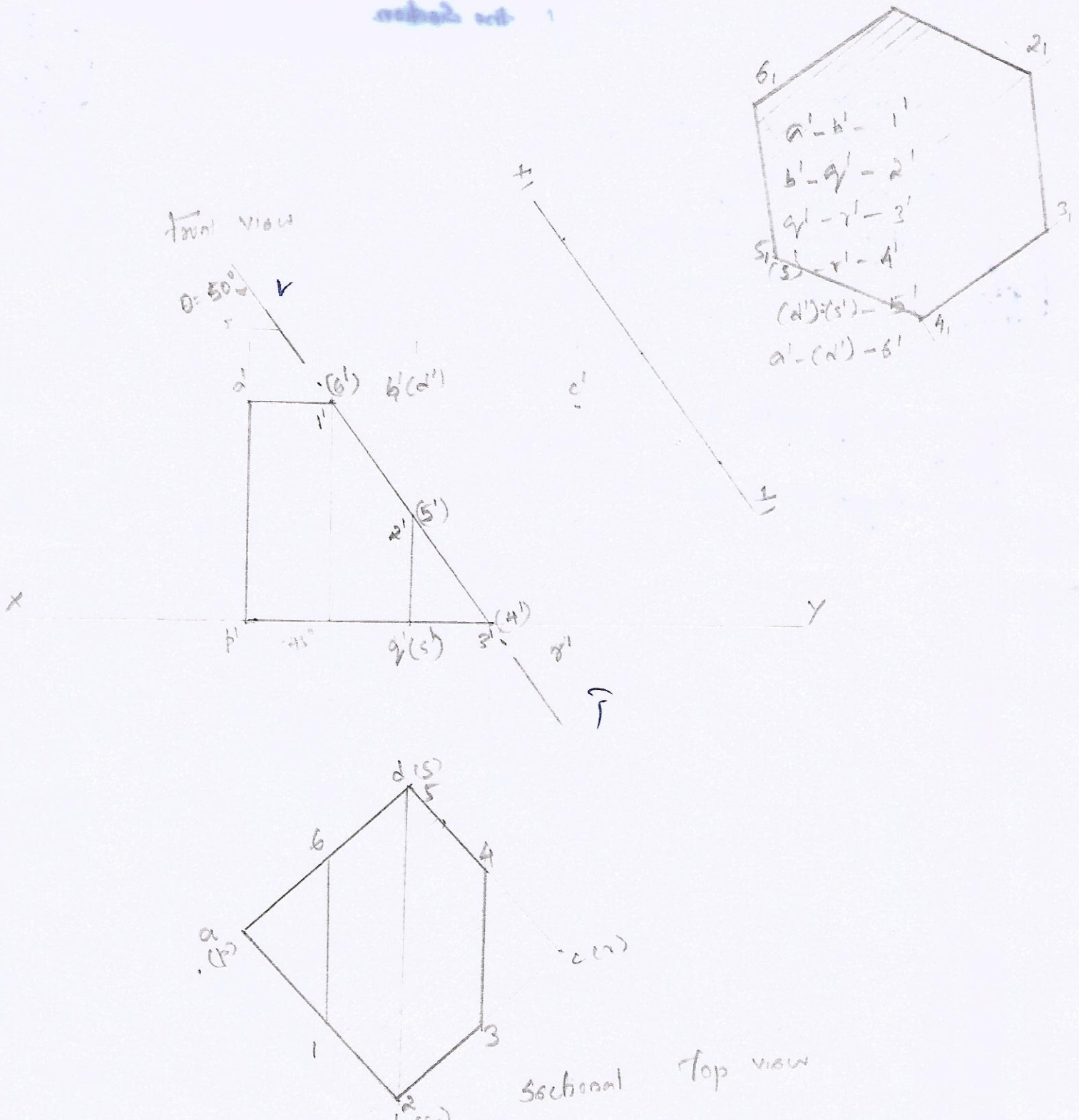

Sections of Prisms

5. A square Prism of base side 30mm and height 60mm rests on the HP on one of its ends with two of its rectangular faces equally inclined to the VP. It is cut by a plane perpendicular to the VP and inclined at 60° to the HP meeting the axis at 15mm from the top. Draw its front view, sectional top view and the true shape of the section.

Rectangular face
Equally inclined to VP
 \therefore Draw the face at 45° in HP
Cutting plane inclined at 60° to HP
 \therefore Cutting plane in VP

$a'p' = 1'$
 $b'q' = 2'$
 $c' = b' = 3'$
 $c' - (d) = 4'$
 $(d') - (s') = 5'$

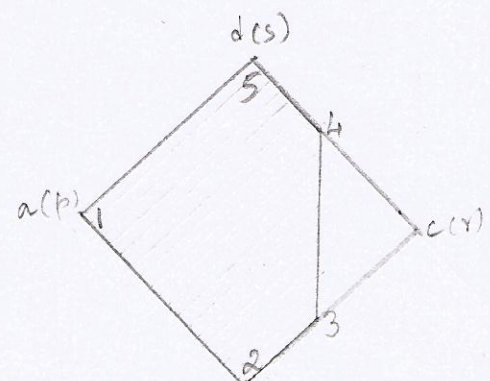
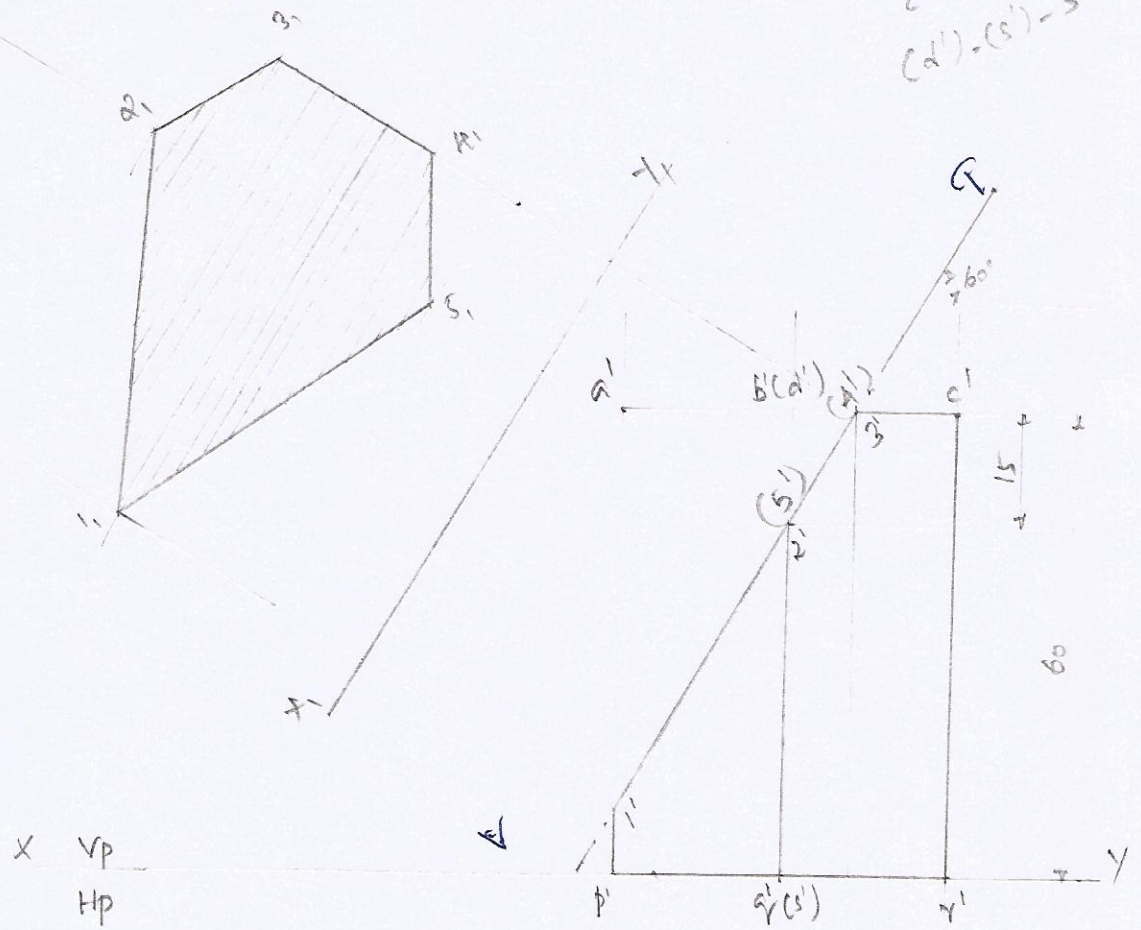

6. A hexagonal prism of base side 30mm and axis length 70mm rests on the HP on one of its rectangular faces with its axis perpendicular to the VP. It is cut by a vertical plane inclined at 30° to the VP. The cutting plane meets the axis at a distance of 30mm from one end. Draw the top view, sectional front view and the true shape of the section.

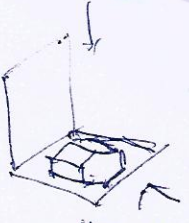

Hexagon in VP
 cutting plane inclined to VP
 \therefore cutting plane in HP

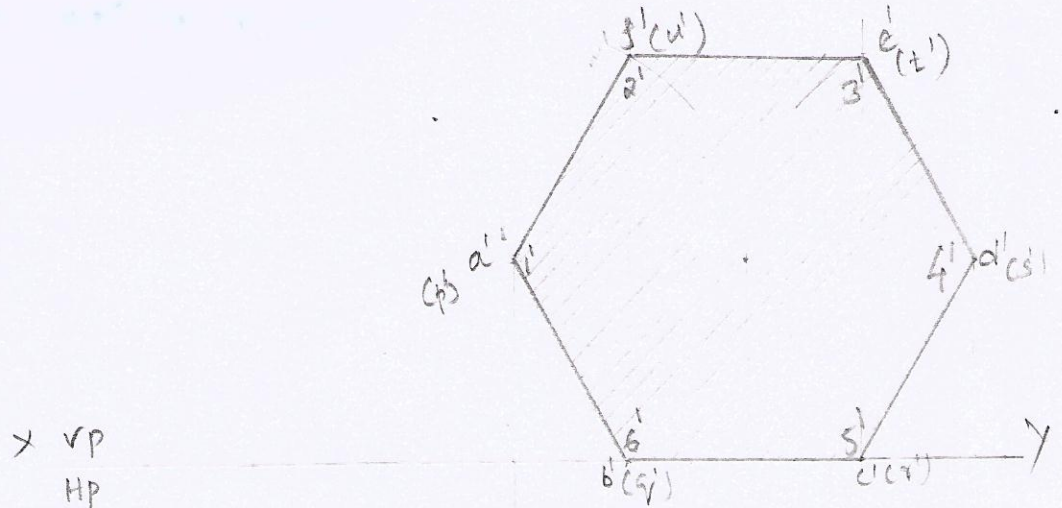

X VP
 HP

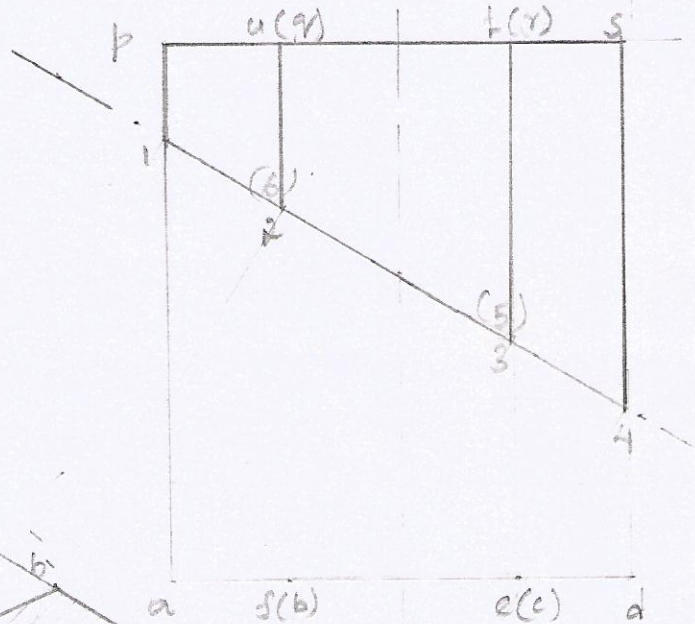

Measured from front view

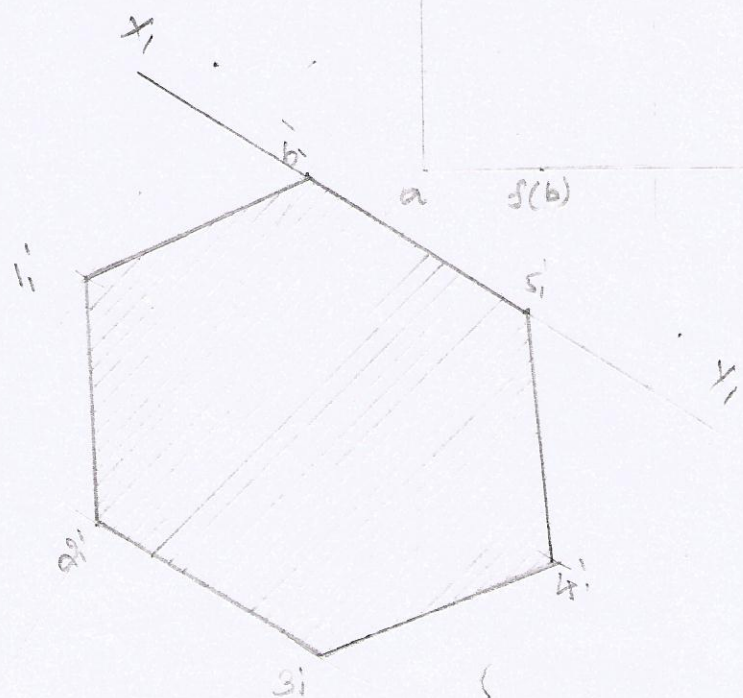

7. A hexagonal Prism of base side 30mm and axis length 70mm rests on one of its ends on the Hp with two base sides parallel to the Vp. It is cut by a plane \perp to the Vp and inclined at 30° to the Hp. (The cutting plane meets the axis at 30mm from the top. Draw the front view, Sectional top view and the true shape of the section.

Rest on Hp.
 \therefore f.v in x-y line.
 Cutting plane inclined to Hp
 \therefore Plane in Vp
 Two base sides parallel to Vp

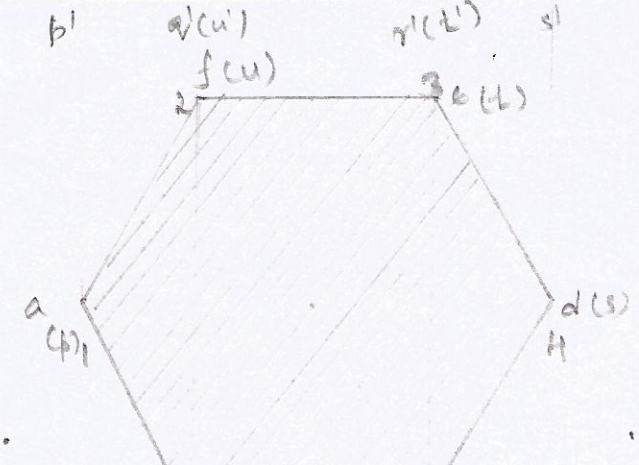
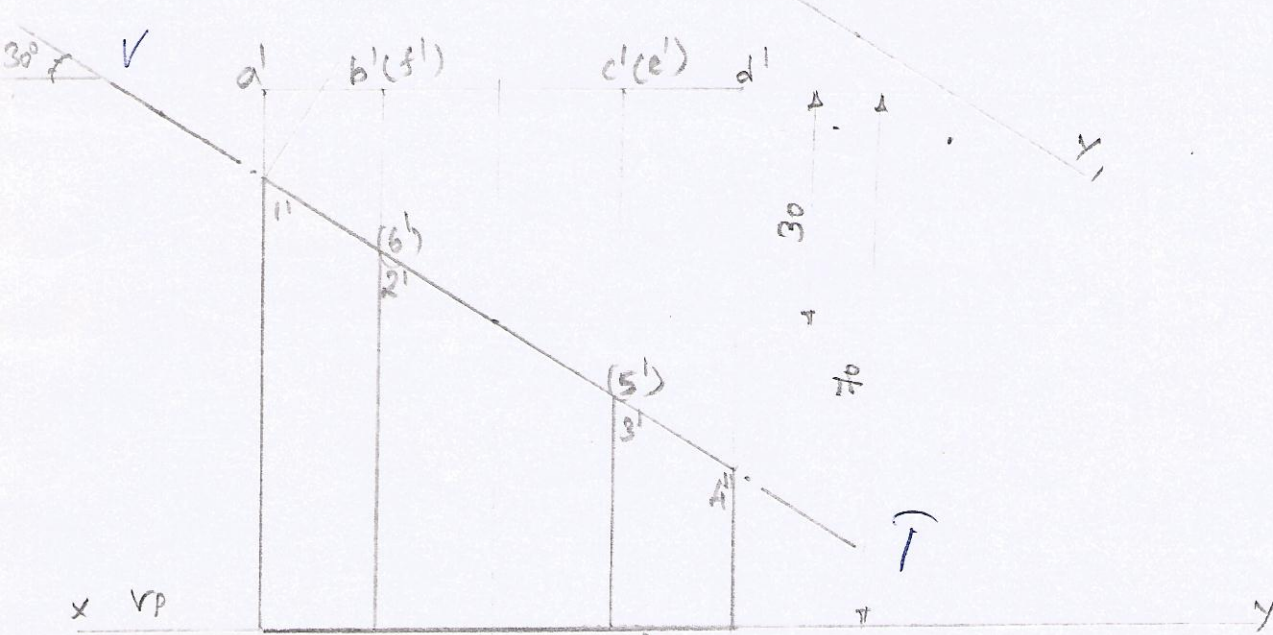
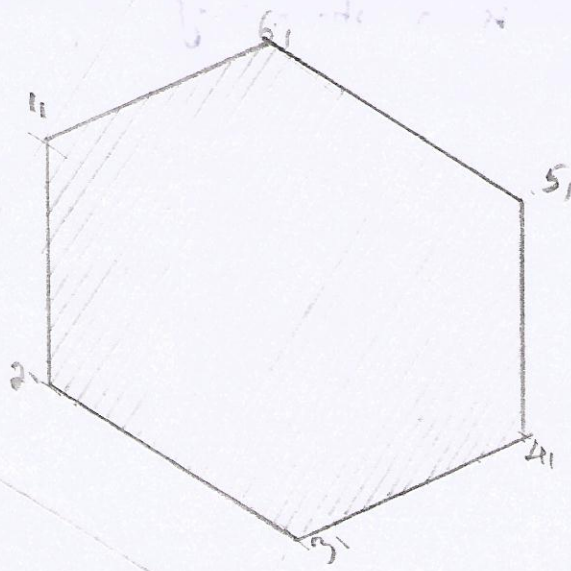
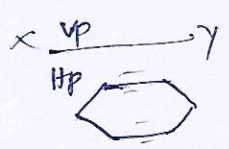

8. A square Prism of height 80mm and base of diagonal 60mm rests on the Hp on its base with base edges equally inclined to the V.P. It is cut by a section plane passing through the mid-point of the axis of the Prism perpendicular to the vp and inclined to the Hp. Find the inclination of the cutting plane if the true shape of the section is a rhombus of diagonals 60mm and 40mm.

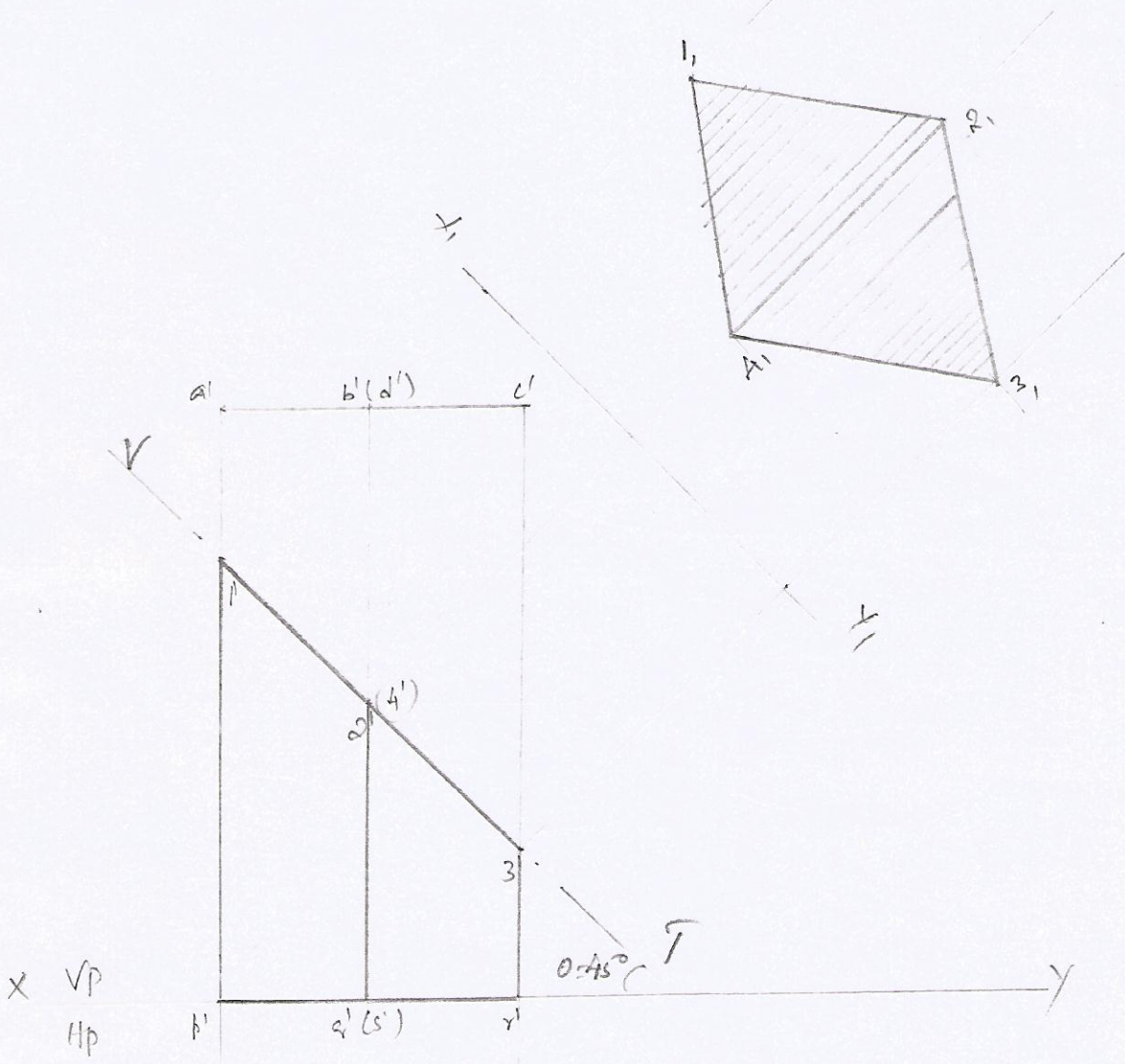

$a' - b' - c'$
 $b' - d' - a'$
 $d' - c' - b'$
 $(a') - (c') - b'$

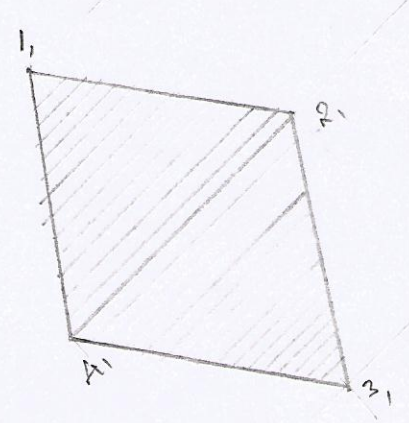

Sections of Pyramids

9. A Pentagonal Pyramid of base side 20mm and altitude 55mm rests on its base on the HP with one of the base edges perpendicular to the VP. It is cut by a plane inclined at 50° to the base. The cutting plane meets the axis at 15mm above the base. Draw the front view, sectional top view and the true shape of the section.

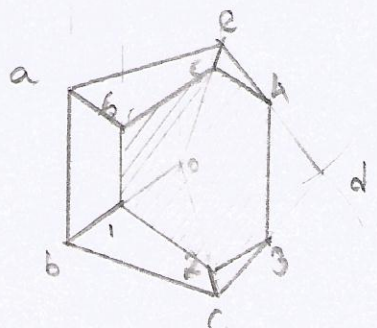
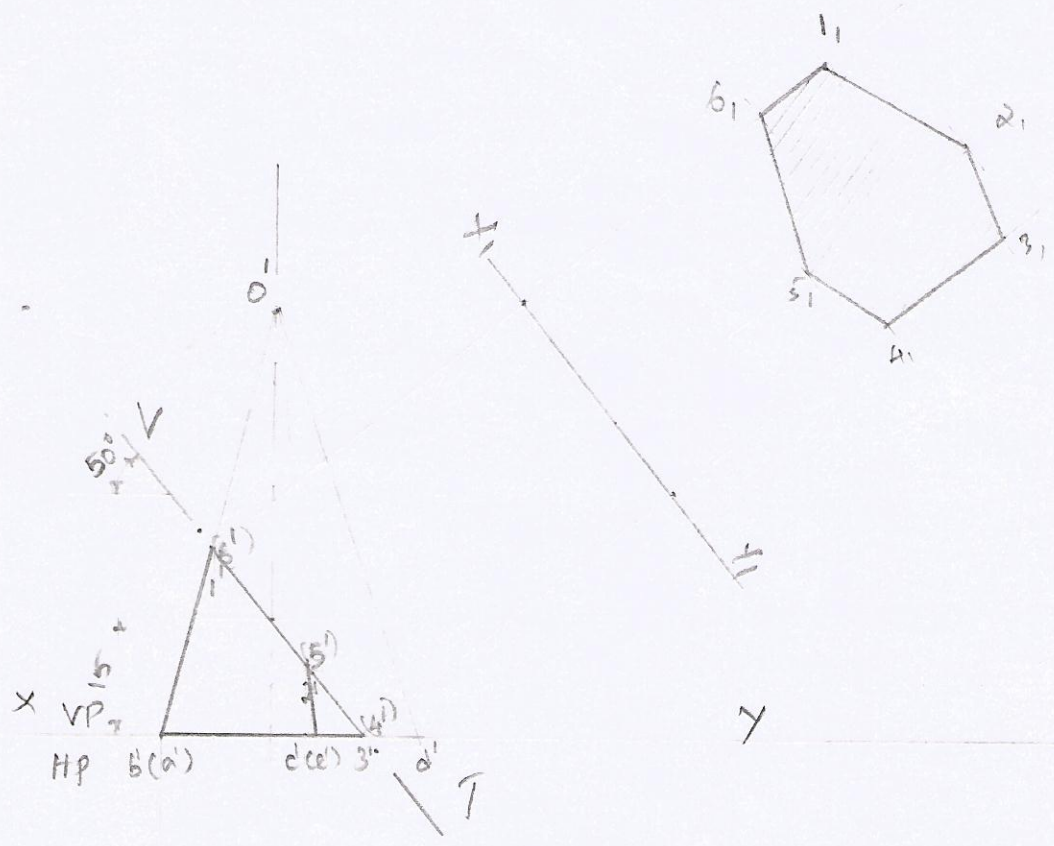

- o-b-1
- o-c-2
- d'-c'-3
- a'-(d')-4
- o-(e)-5
- o-(a')-6

10. A hexagonal Pyramid of base side 25mm and axis 55mm rests on its base on the Hp with two base edges perpendicular to the Vp. It is cut by a plane \perp^r to the Vp and inclined at 30° to the Hp meeting the axis at 20mm from the vertex. Draw the front view, Sectional top view & the true shape of the section.

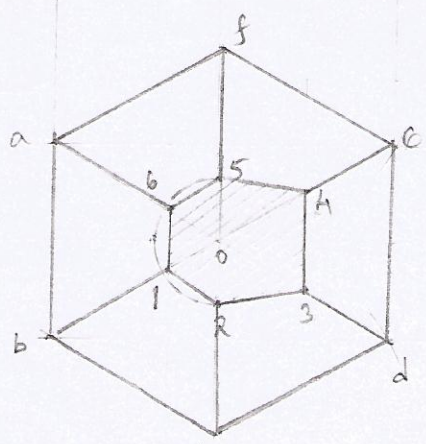
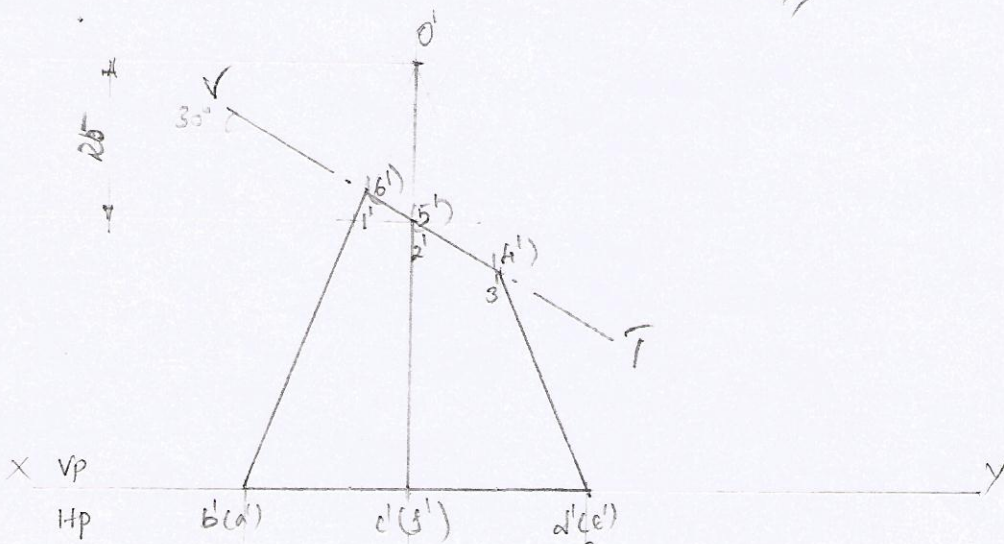
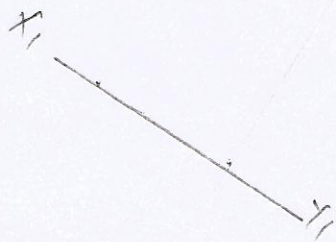
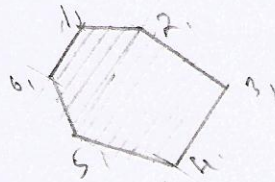

- $o' - b' - 1'$
- $o' - c' - 2'$
- $o' - d' - 3'$
- $o' - (e') - 4'$
- $o' - (f) - 5'$
- $o' - (a') - 6'$

11. A Pentagonal Pyramid of base side 40mm and altitude 80mm rests on the Hp on its base with an edge of the base parallel to the vp. It is cut by a vertical plane inclined at 55° to the vp at a distance 10mm from the axis. Draw the top view, sectional front view and the true shape of the section.

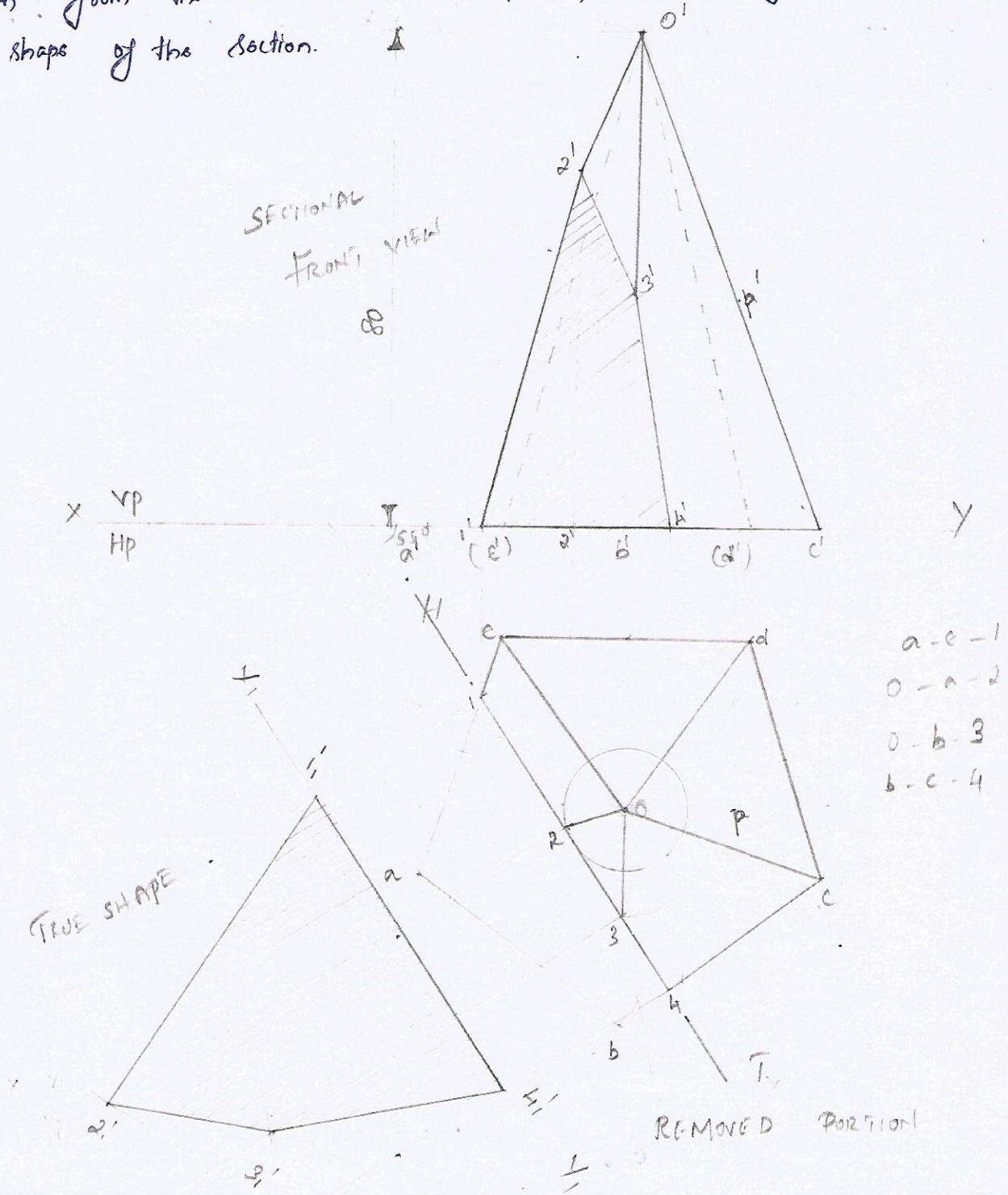

12. A square pyramid of base side 25mm and altitude 40mm rests on the HP on its base with the base edges equally inclined to the VP. It is cut by a plane perpendicular to the VP and inclined at 30° to the HP meeting the axis at 21mm above the HP. Draw the sectional top view and the true shape of the section.

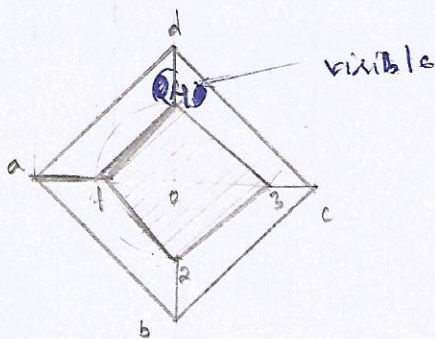
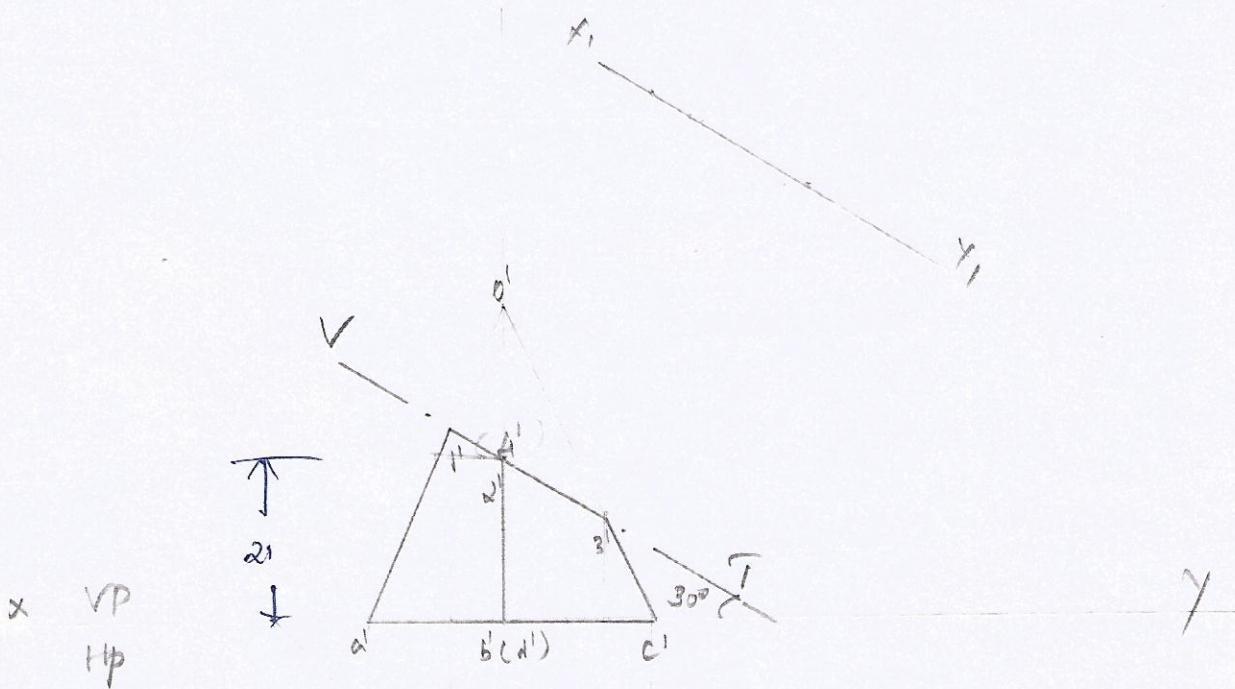
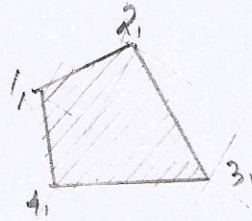

Sections of cylinders

13. A cylinder of diameter 100mm and height 50mm rests on its base on the HP. It is cut by a plane \perp^r to the VP and inclined at 50° to the HP. The cutting plane meets the axis at a distance of 15mm from the top. Draw the front view, sectional top view and the true shape of the section.

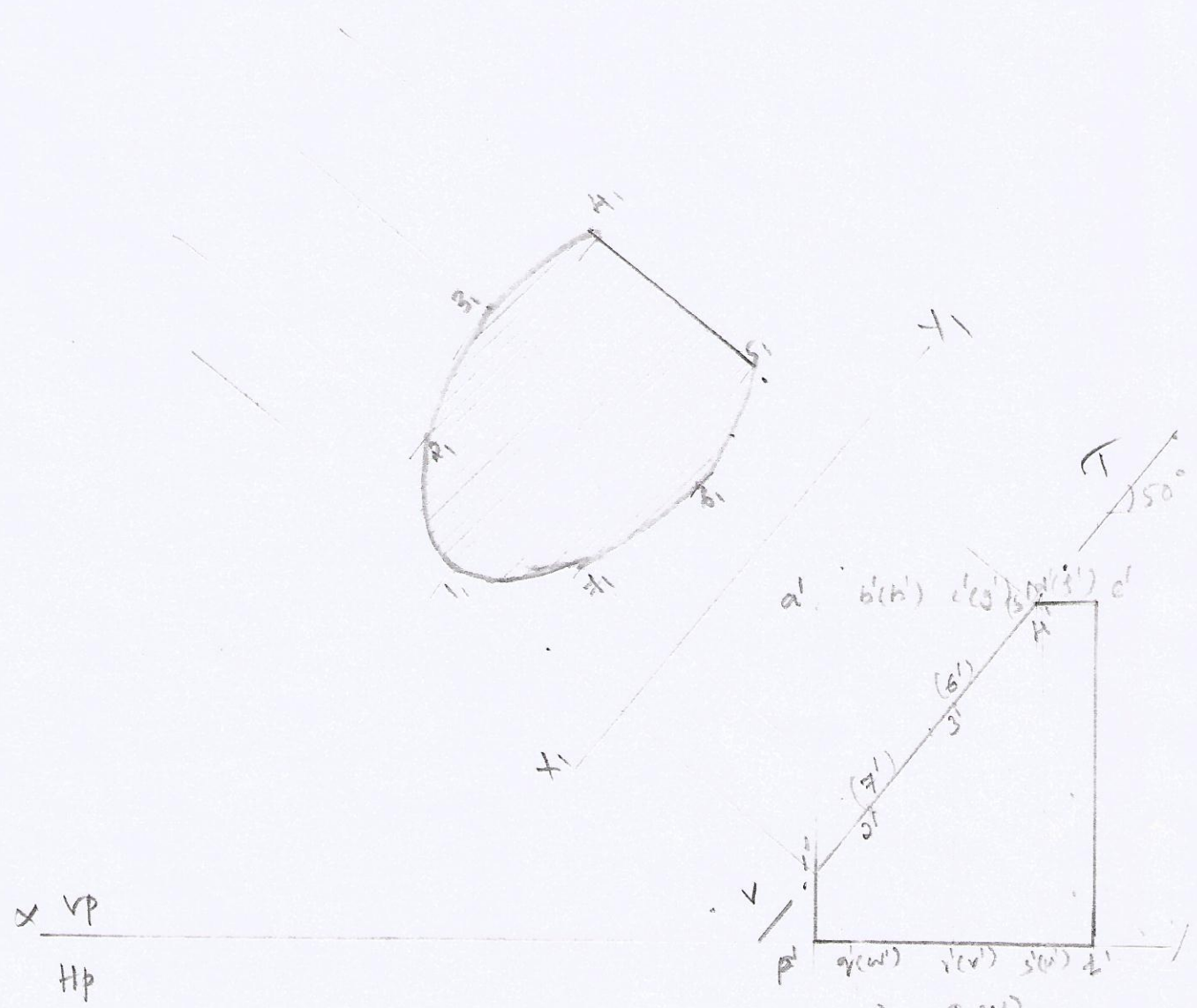

$a' - p - 1'$
 $b' - q - 2'$
 $c' - r - 3'$
 $d' - s' - 4'$ $e' - d - 1'$
 $(f') - (u) - s' e' - (t') - s'$

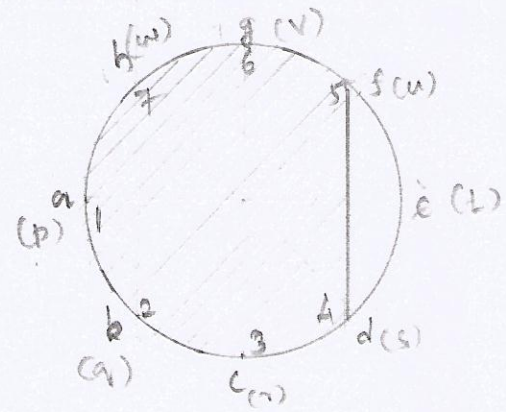

14. A cylinder of diameter 80mm and height 60mm rests on its base on the Hp. It is cut by a plane \perp to the vp and inclined at 30° to the Hp. The plane bisects the axis. Draw the front view, sectional top view, & the true shape of the section.

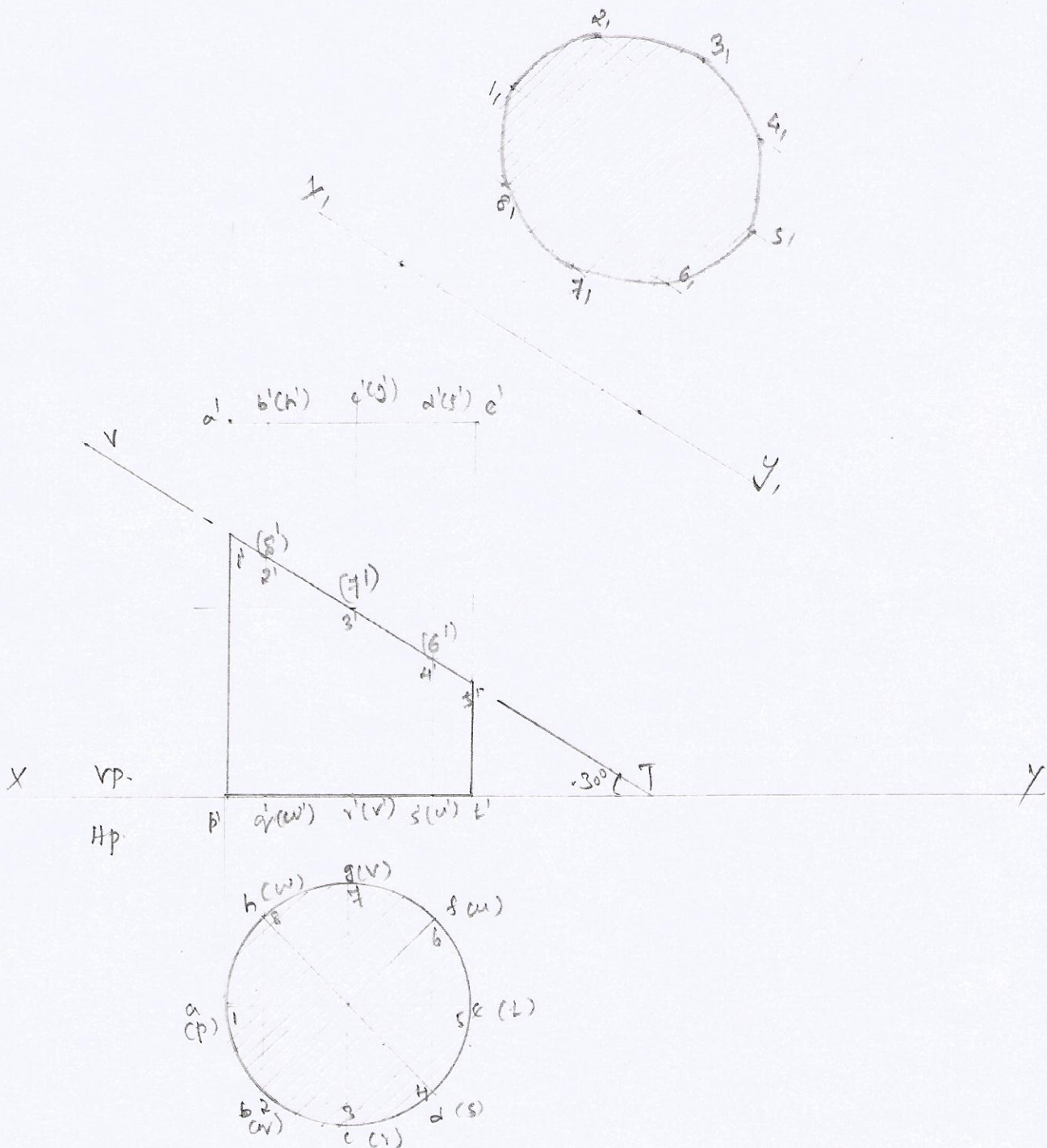

Sections of cones:

15. A cone of base diameter 40mm and height 50mm rests on its base on HP. It is cut by a Plane \perp to the VP, and inclined at 40° to the HP. The cutting plane meets the axis at 20mm from the Vertex. Draw the Sectional top view and the true shape of the section.

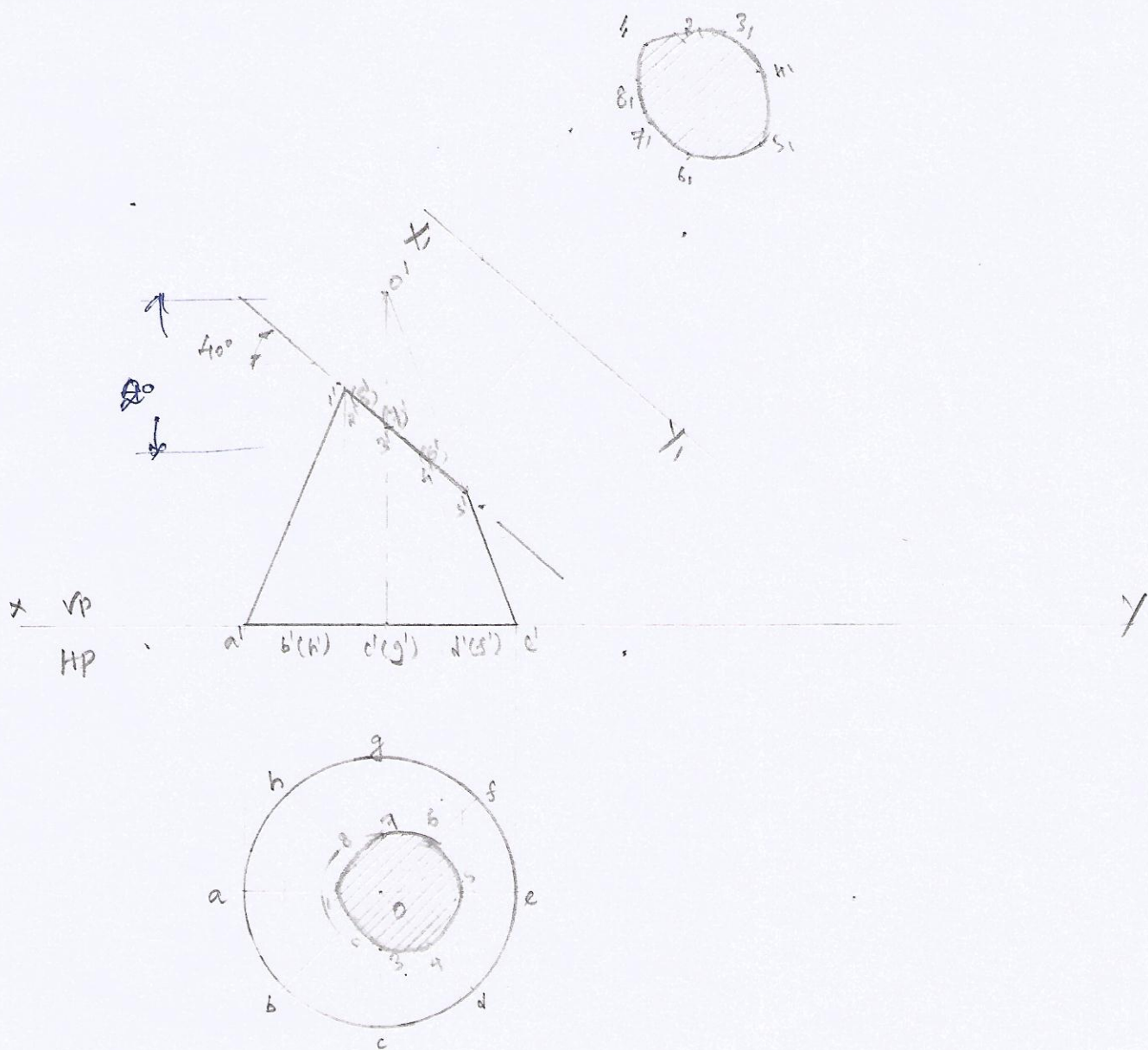

16. A cone of base diameter 50mm and altitude 60mm rests on its base on the HP. It is cut by a plane \perp to the VP & parallel to one of the extreme generators, 10mm away from it. Draw the sectional top view & the true shape of the section.

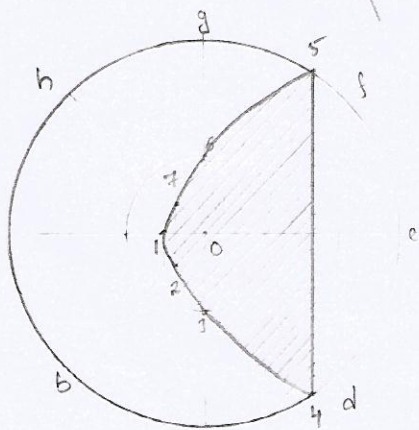
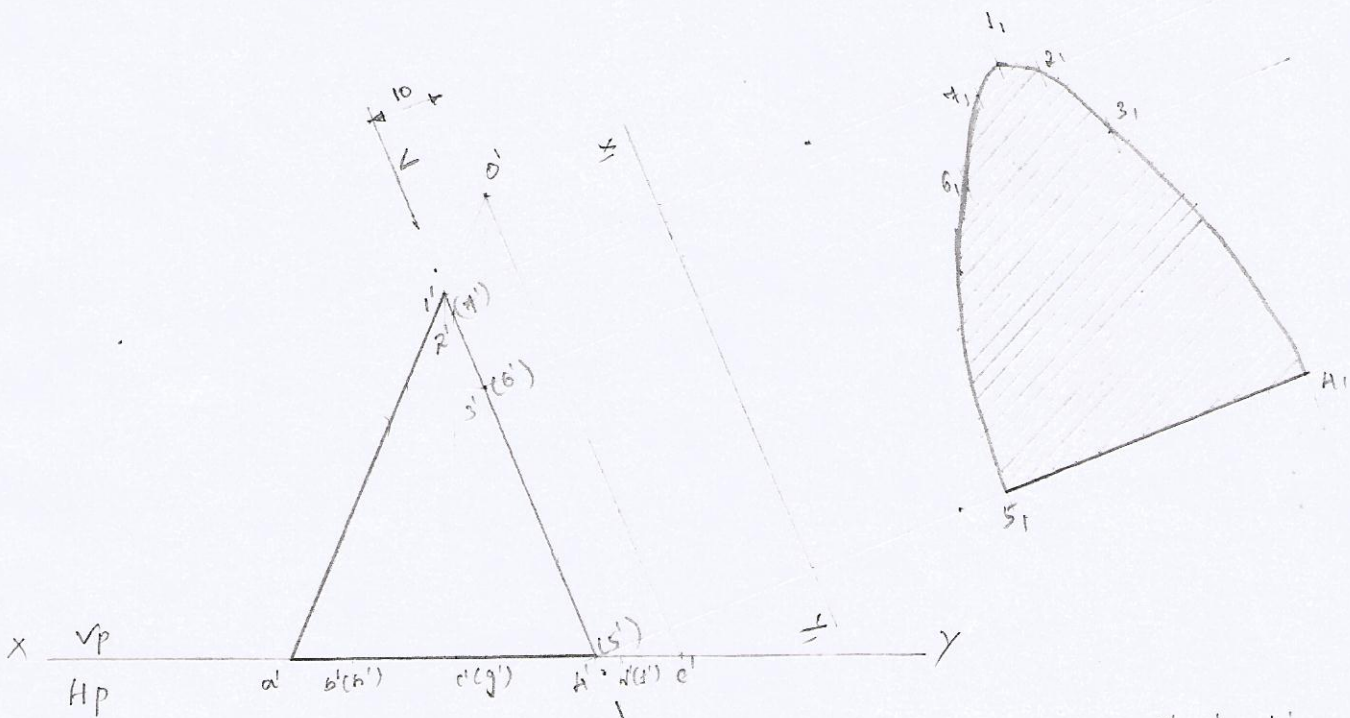

$O'-a'-1'$
 $O'-b'-2'$
 $O'-c'-3'$
 $e'-d'-4'$
 $e'-f'-5'$
 $O'-g'-6'$
 $O'-h'-7'$

A cone of base diameter 40mm and altitude 50mm rests on its base on the HP. It is cut by a plane \perp to the VP and inclined at 60° to the HP. The cutting plane meets the axis at 27mm from the vertex. Draw the sectional top view & the true shape of the section.

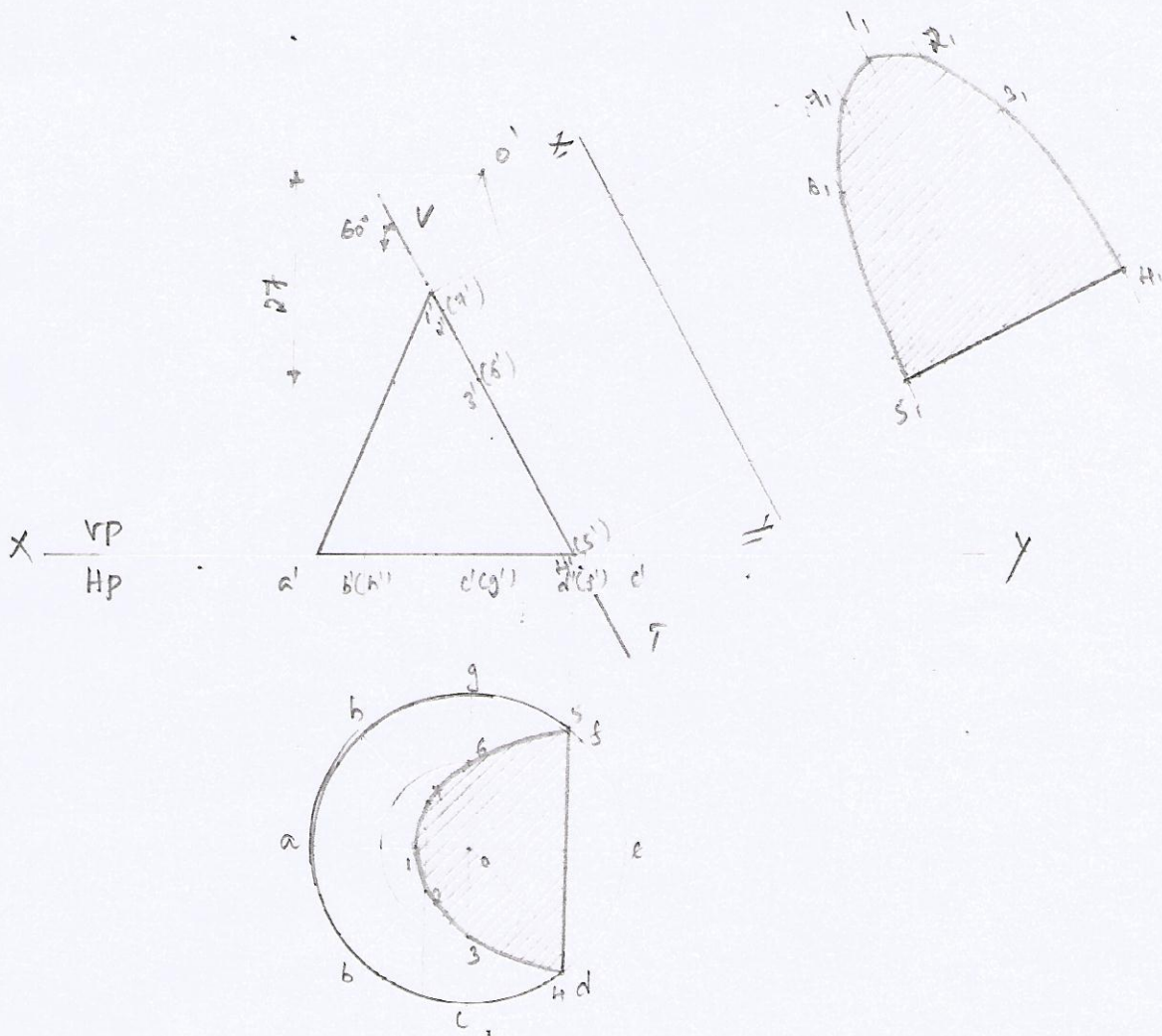

18. A cone of base diameter 40 mm and altitude 50 mm rests on its base on the Hp. It is cut by a section plane \perp to the Vp & inclined at 80° to the Hp, passing through the apex. Draw the sectional top view and the true shape of the section.

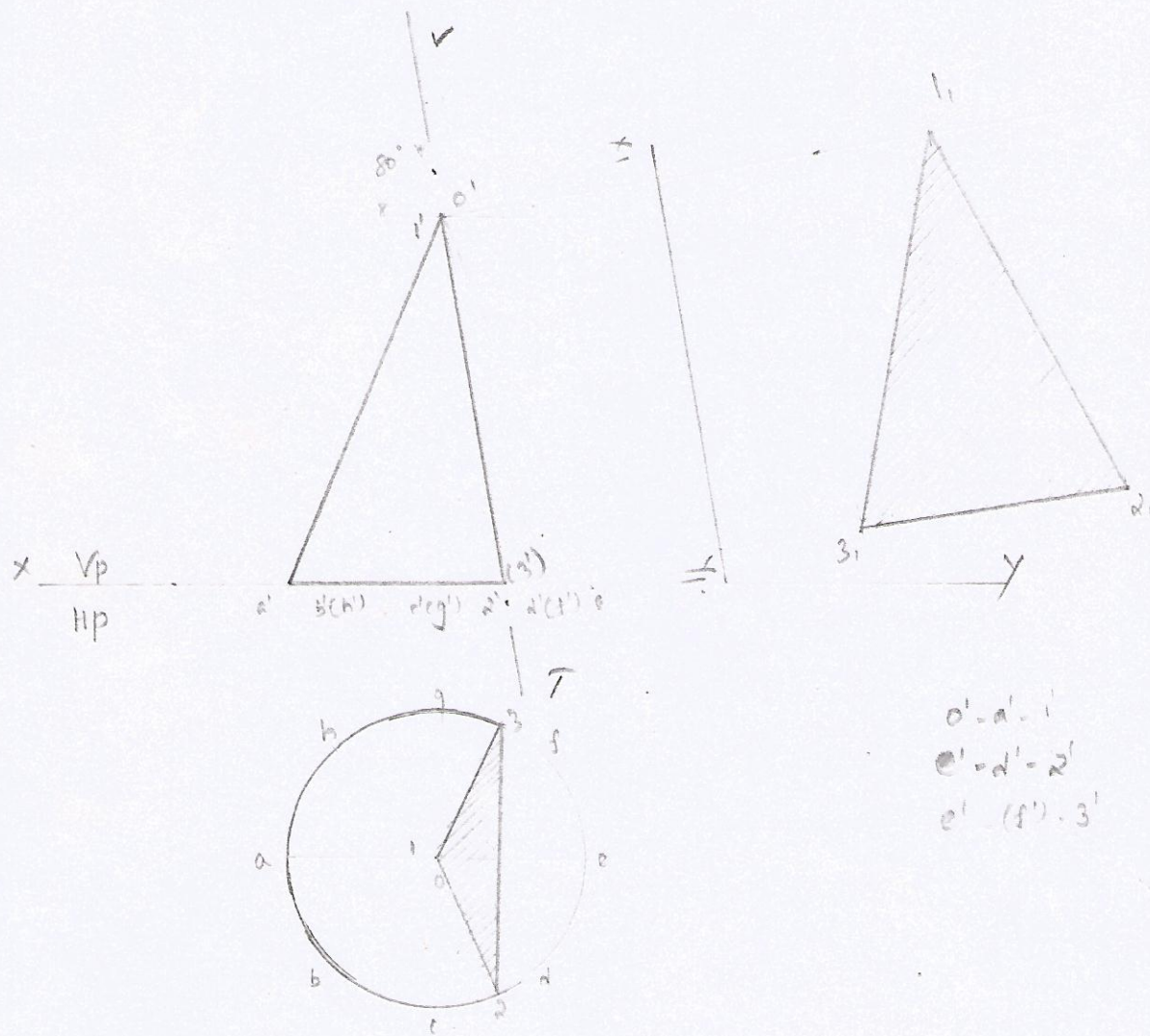

$o' - a' - 1$
 $e' - d' - 2'$
 $e' - (f') - 3'$

Development of Prism:

1. A hexagonal Prism of base side 20mm and height 45mm is resting on one of its ends on the hp with two of its lateral faces parallel to the vp. It is cut by a plane \perp to the vp & inclined at 30° to the hp. The plane meets the axis at a distance of 20mm above the base. Draw the development of the lateral surfaces of the lower portion of the prism.

- $a' - p' - 1'$
- $b' - q' - 2'$
- $c' - r' - 3'$
- $d' - s' - 4'$
- $(6') - (e') - (5')$
- $(3') - (u') - (6')$

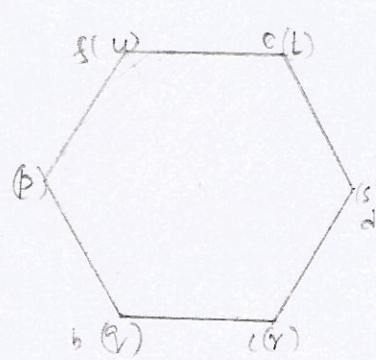
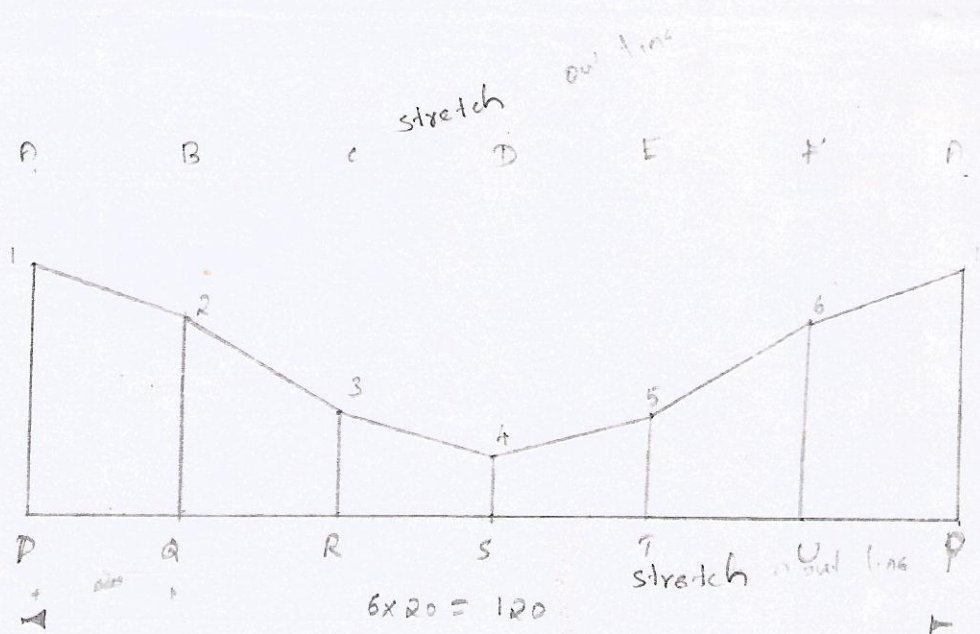
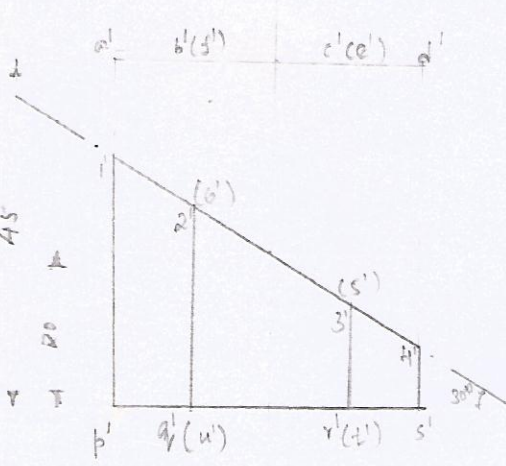

2. A Pentagonal Prism of base side 25mm & height 50mm is resting with one of the rectangular faces parallel to VP and it is cut by a plane \perp to VP & 30° to HP, meets the axis at a height of 25mm above the base. Draw the development of lower portion of the Prism.

5x25 = 125

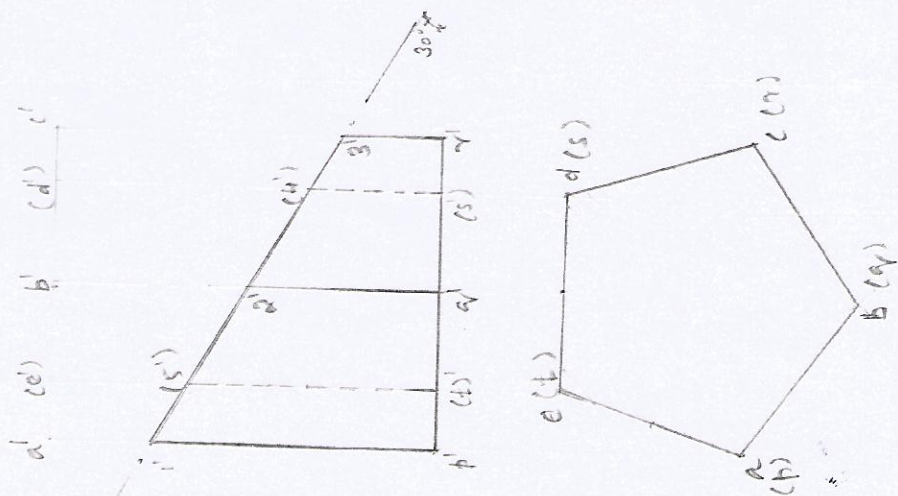
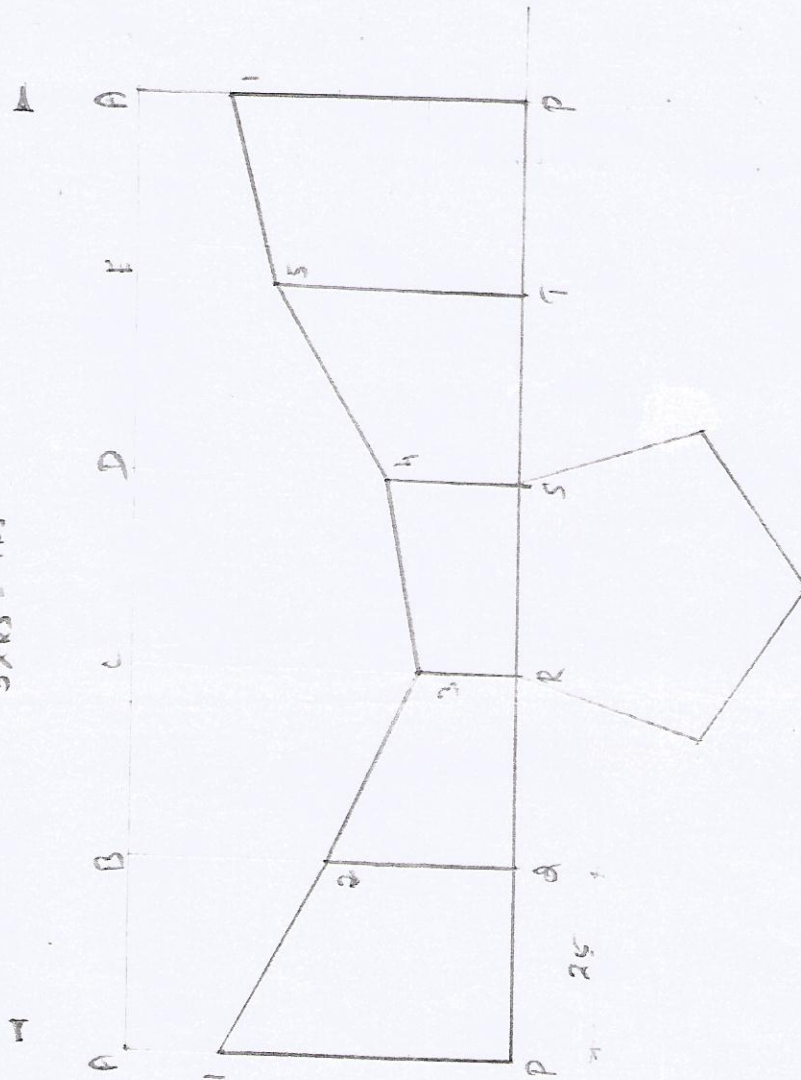

3. A Pentagonal Prism of base side 20mm and height 60mm is cut by two planes as shown in fig. Draw the development of the lateral surface of the position b/n the cutting planes.

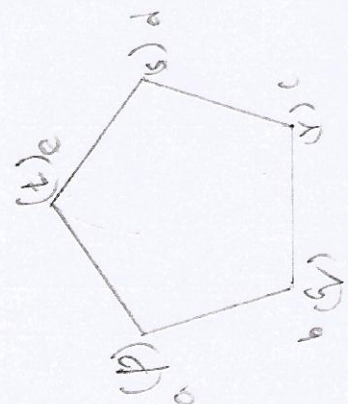
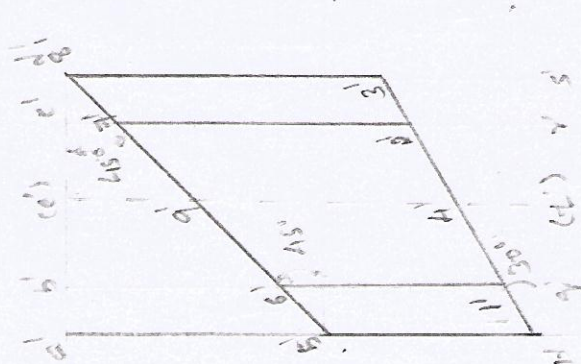
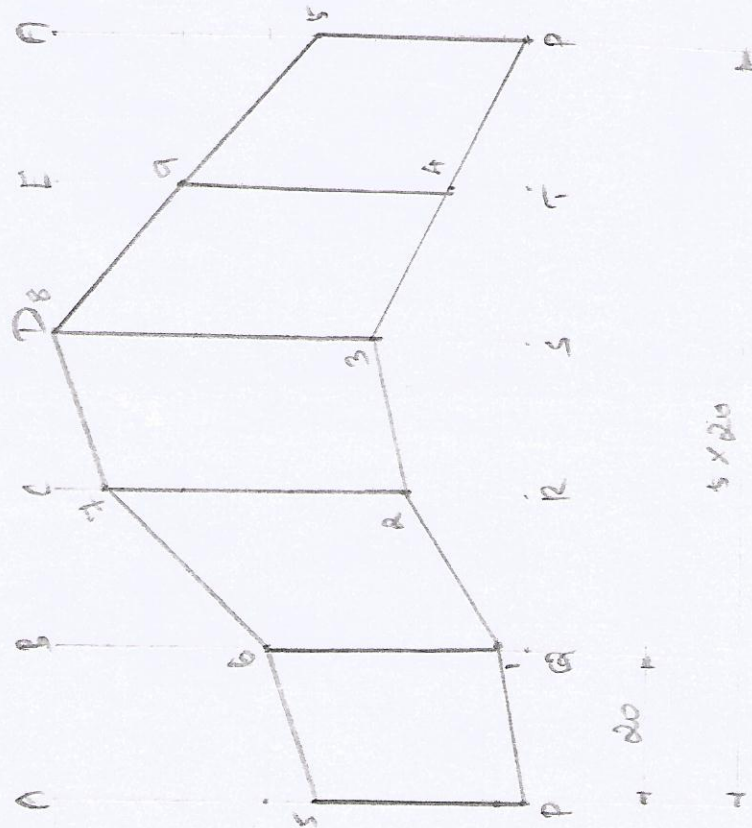

4. A Pentagonal Prism of base side 25mm and height 60mm stands on one of its ends on the Hp with a rectangular face Parallel to the Vp. A hole of diameter 30mm is drilled centrally through the Prism in such a way that the axis of the hole bisects the axis of the Prism at right angles. The axis of the hole is \perp to the Vp. Draw the development of the lateral surfaces of the Prism.

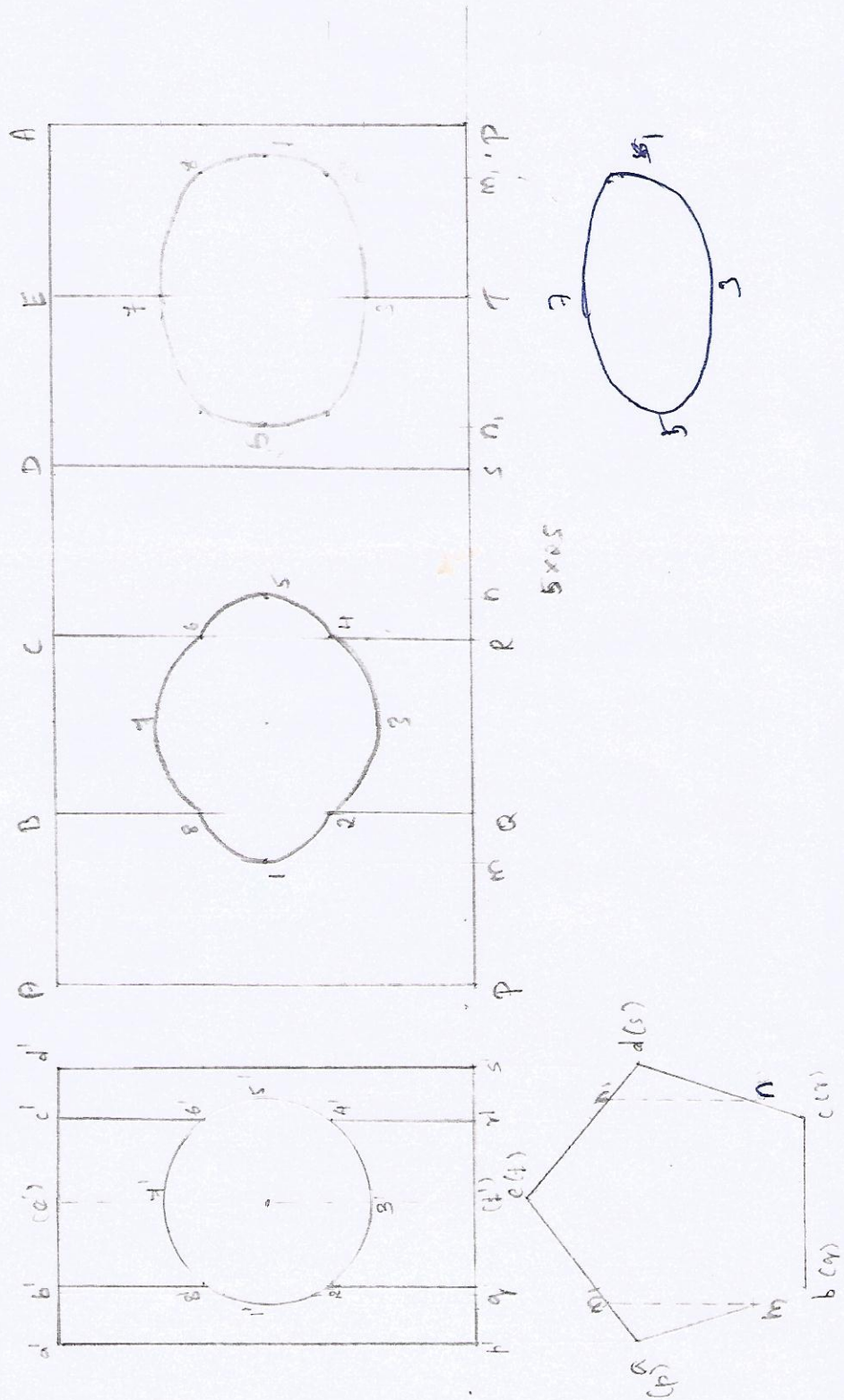

6. A hexagonal prism of base side 25mm and height 50mm rests vertically on the HP with a base side parallel to VP. A string is wound round the surface of the prism starting from extreme point on the base, passing through the diametrically opposite corner on the top end & ending at the starting point. Find graphically the shortest length of the string required. Also show the path of the string in the front view.

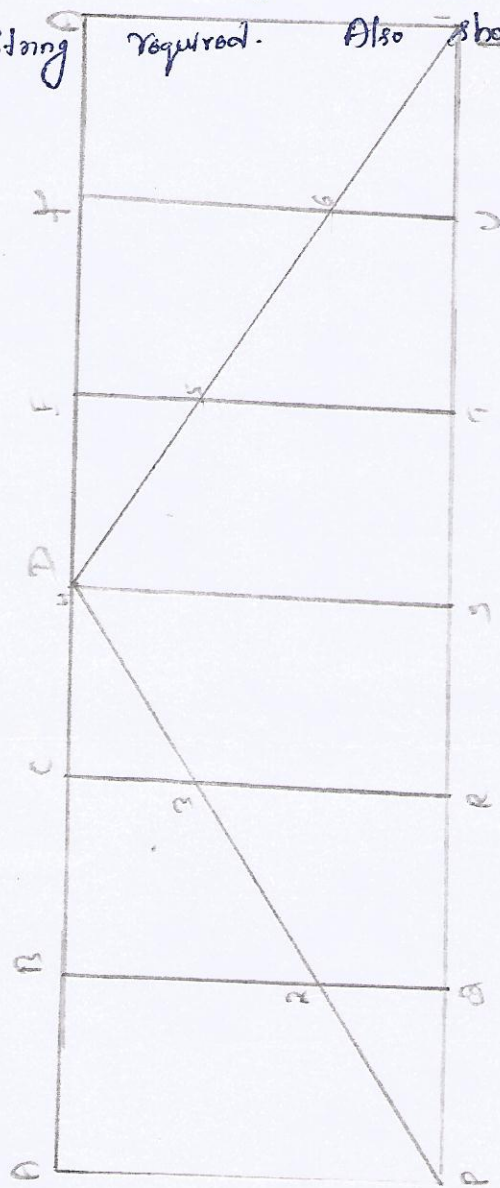

6 x 25 = 150

50 = 150 + 50 = 200

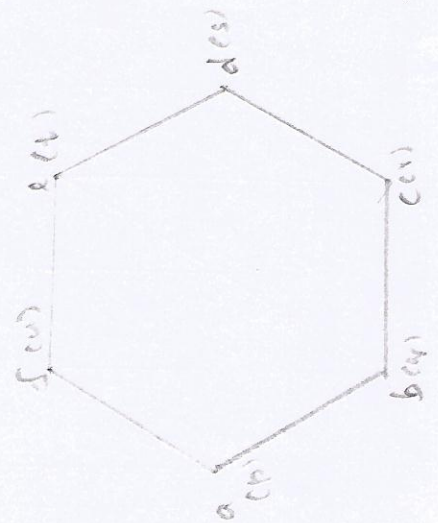
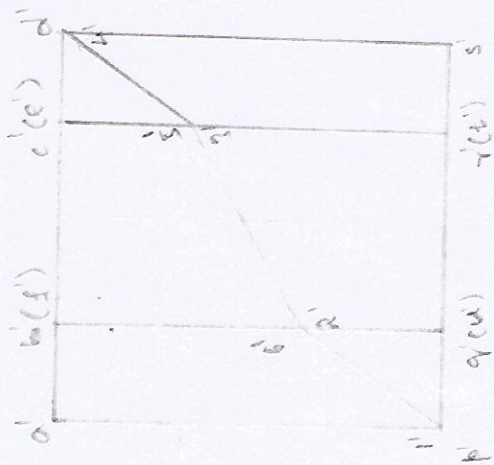

Development of cylinders

5. A cylinder of diameter 40 mm and height 50 mm is resting vertically on one of its ends on the HP. It is cut by a plane \perp to the VP and inclined at 30° to the HP. The plane meets the axis at a point 30 mm from the base. Draw the development of the lateral surface of the lower portion of the ~~truncated~~ truncated cylinder.

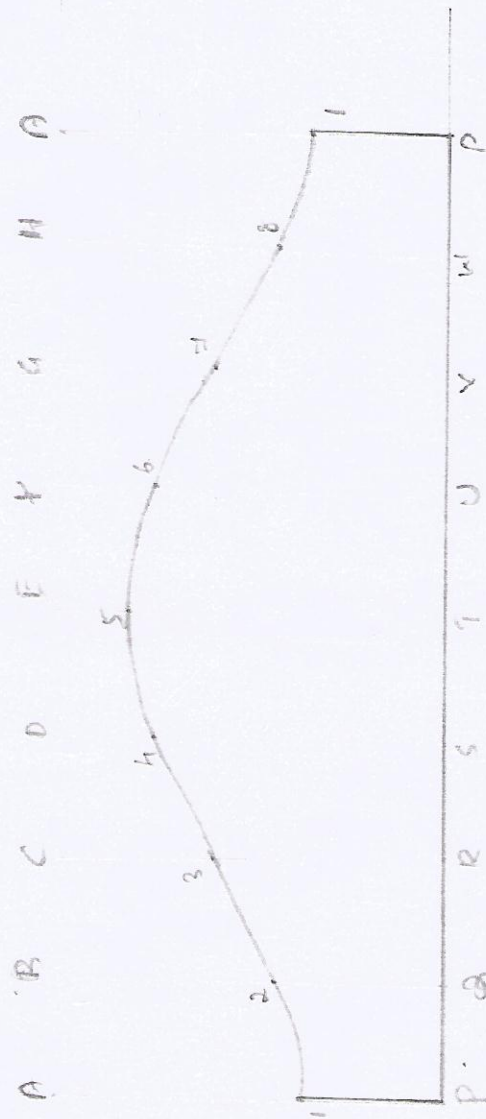

27/11/20 or 10/11

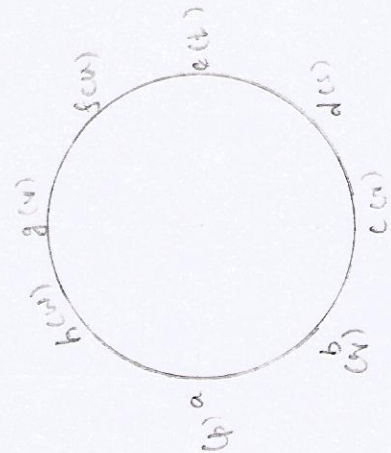
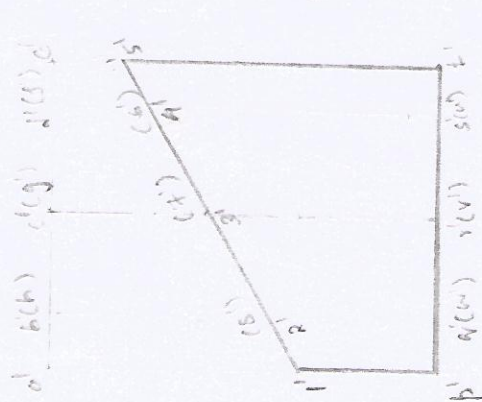

Q.7. Draw the development of the lateral surface of the right portion of the cylinder of diameter 50 mm & height 65 mm cut by a plane inclined at 60° to the base and passing through the axis at a height of 40 mm above base as shown in fig.

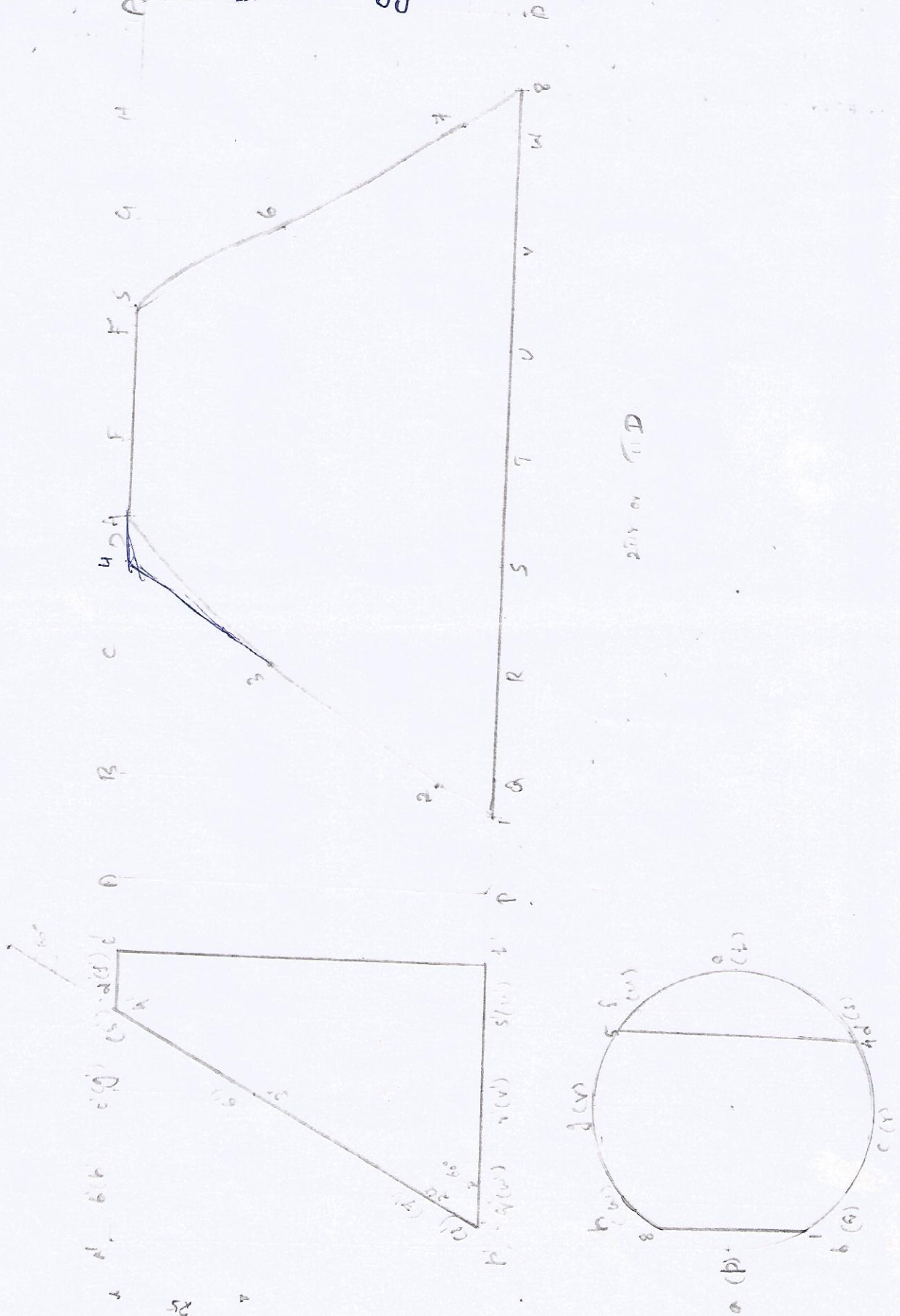

Q. A circular hole of diameter 20mm is drilled through a vertical cylinder of diameter 50mm and height 65mm. The axis of the hole is \perp to the VP and meets the axis of the cylinder at right angles at a height of 30mm above the base. Draw the development of the lateral surface of the cylinder.

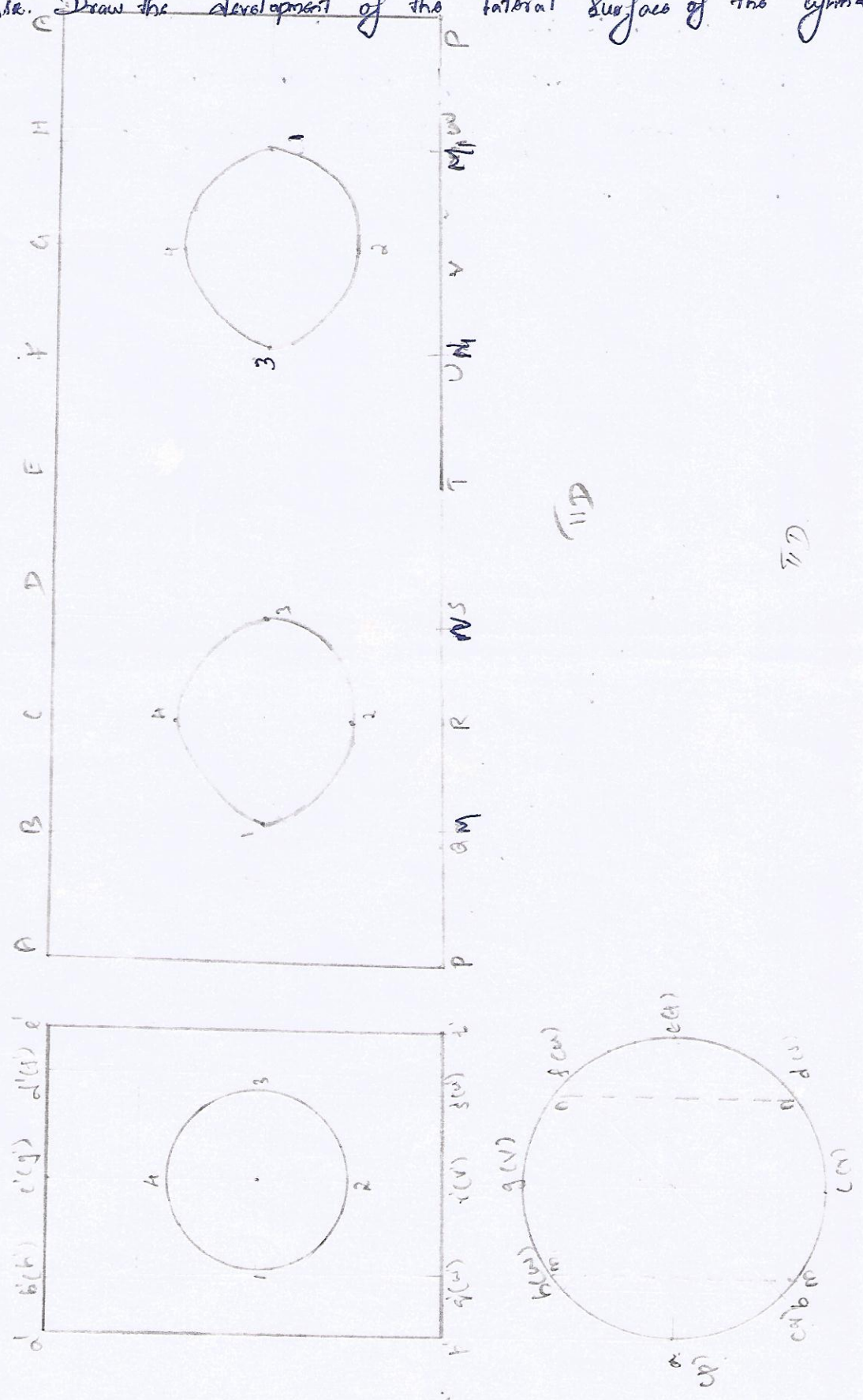

Development of Pyramids

9. A Pentagonal Pyramid of base side 25mm & height 60mm is resting vertically on its base on the ground with one of the sides of the base Parallel to the vp. It is cut by a plane ∥ to the vp & Parallel to the hp at a distance of 25mm above the base. Draw the development of the lateral surfaces of the frustum of the pyramid. Also show the top view of the cut surface.

Radius: True length of slant edge

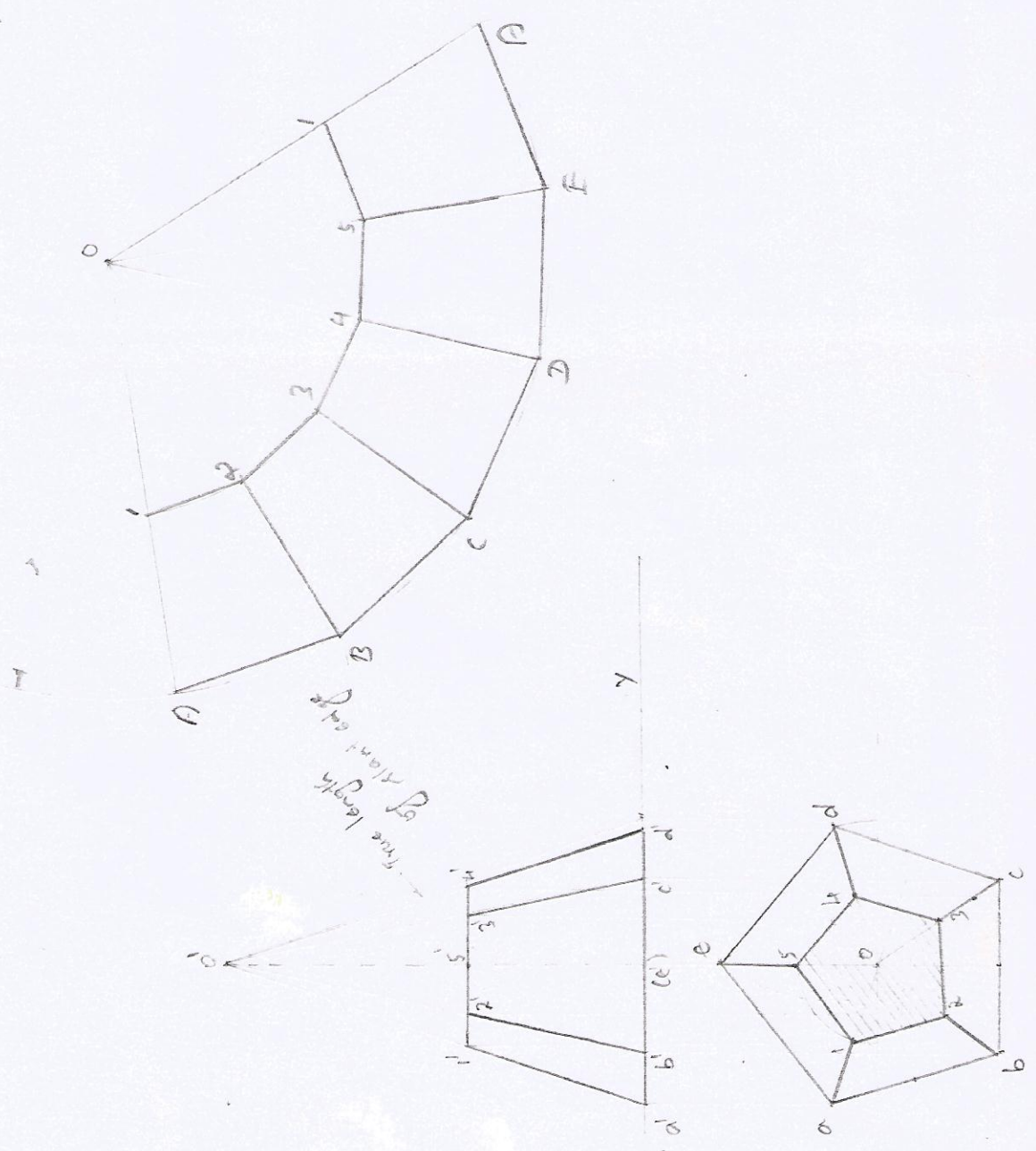

10. A hexagonal Pyramid of base of side 25mm & altitude 50mm is resting vertically on its base on the ground with two of the sides of the base \perp to the VP. It is cut by a plane \perp to the VP and inclined at 30° to the HP. The plane bisects the axis of the pyramid. Draw the development of the lateral surfaces of the pyramid.

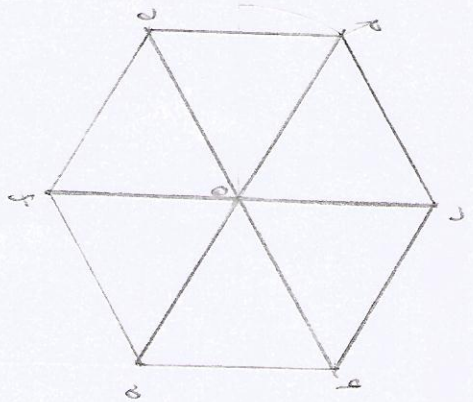
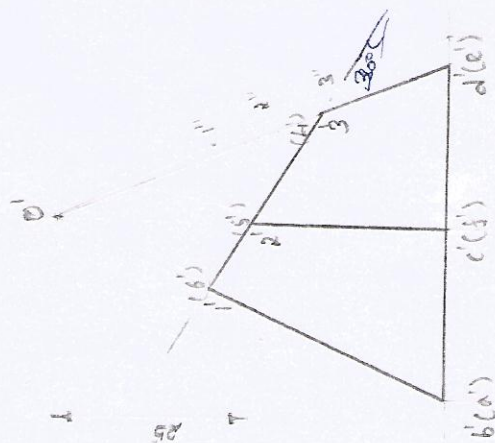
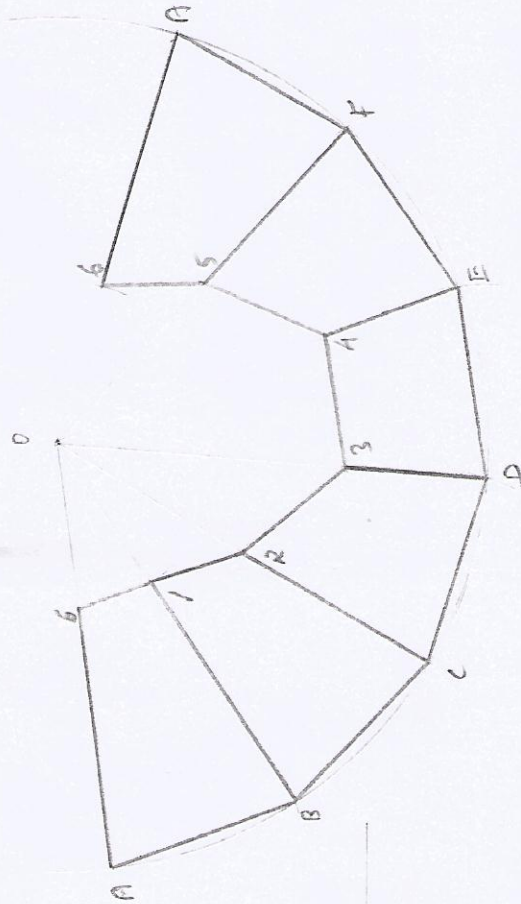

11. A square pyramid of base side 25mm & altitude 50mm rests on its base on the HP with two sides of the base parallel to the VP. It is cut by a plane bisecting the axis and inclined at 30° to the base. Draw the development of the lateral surfaces of the lower part of the cut pyramid.

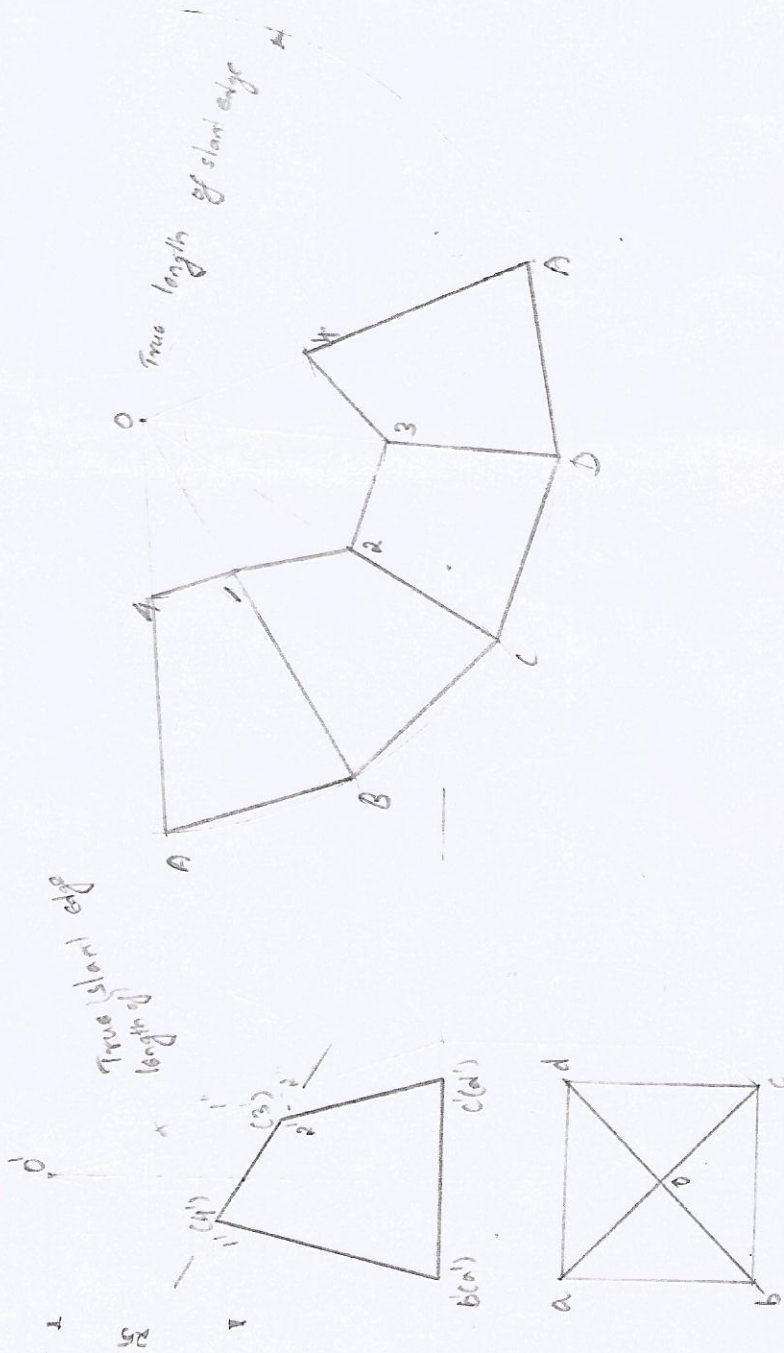

12. A hexagonal Pyramid of base of side 30mm & height 50mm rests vertically on its base on the ground with two of its base sides parallel to the VP. It is cut by a plane inclined at 30° to the HP and l^r to the VP & meeting the axis at a point 10mm below the vertex. There is also a circular slot of radius 20mm from the end view point on the base. Draw the development of the lateral surfaces of the pyramid.



11-12-13-14-15-16-17-18-19-20

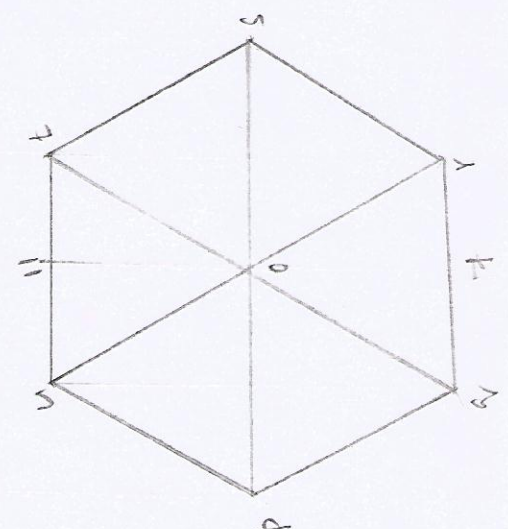

13.

A square pyramid of base side 25mm and axis 60mm rests on its base on the ground with one of the sides of the base inclined at 30° to the VP. A string is wound round the surfaces of the pyramid starting from left extreme point on the base and ending at the same point. Find the shortest length of the string required. Also trace the path of the string in the front & top views.

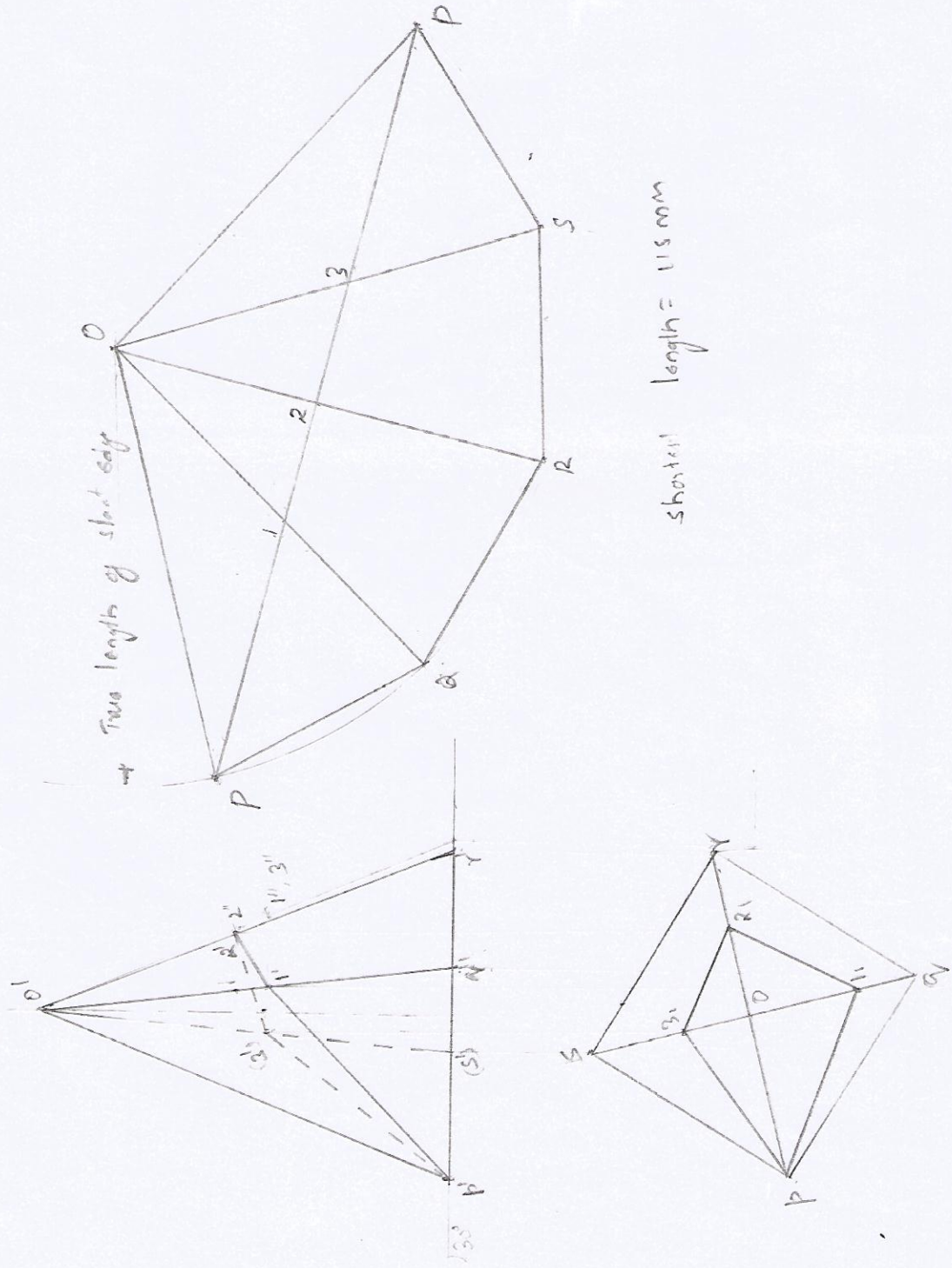

→ True length of slant edge

shortest length = 115 mm

Development of cone:

14. A right circular cone of base diameter 60mm & height 70mm is resting on its base on the ground. It is cut by a plane perpendicular to the VP and inclined at 30° to the Hp. The cutting plane bisects the axis of the cone. Draw the development of the lateral surface of the truncated cone.

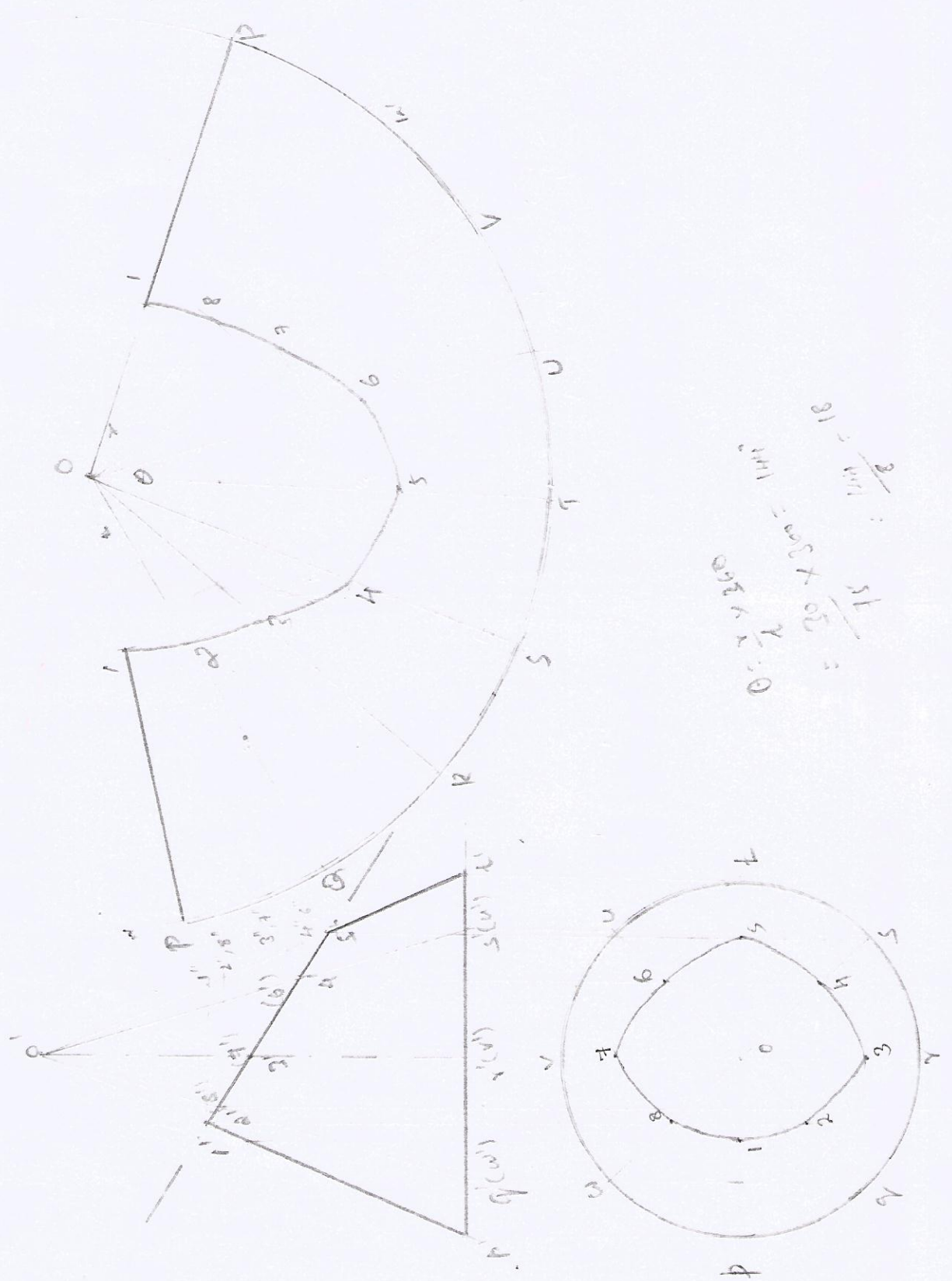

$$81 = \frac{2}{\sin 15^\circ} \times 30 \times 2 \times 300$$

$$= \frac{15}{\sin 15^\circ} \times 30 \times 2 \times 300$$

need

15. A cone of base diameter 60mm & height 70mm is resting on its base on the ground. It is cut by a plane \perp to the VP and parallel to the HP at a distance 20mm from the vertex. It is also cut by a plane inclined at 45° to the base and meeting the axis at a point 20mm above base. Draw the development of the lateral surface of the cut cone.

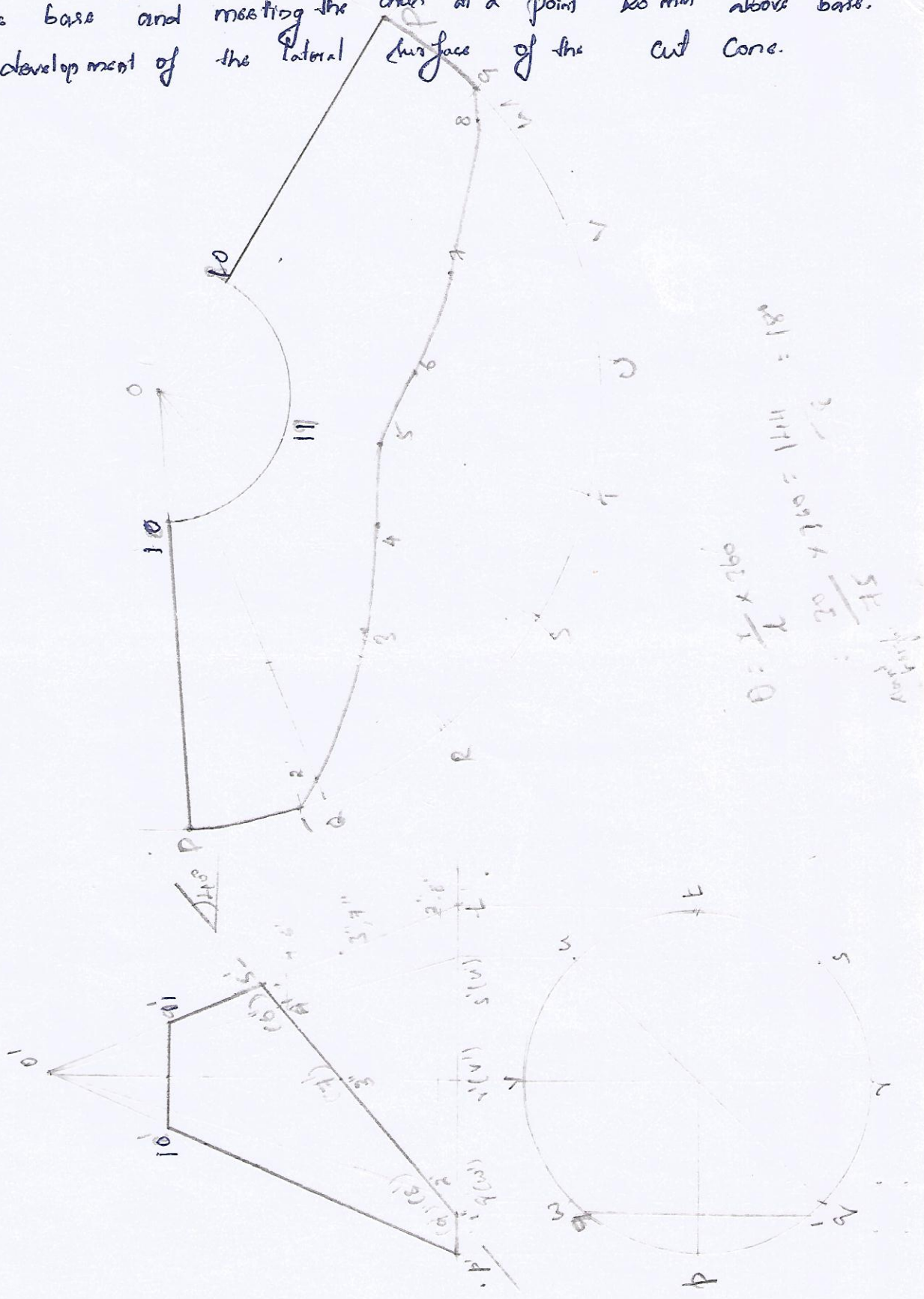

17. A Pentagonal Prism of base edge 20mm and axis length 50mm stands on one of its ends on the Hp with a vertical face parallel to the Vp and further away from it. A square slot of diagonals 20mm is drilled centrally right through the Prism in such a way that one diagonal coincides with the axis of the Prism. The axis of the square slot is \perp to the Vp. Draw the development of the lateral surfaces of the Prism with the square cut-out.

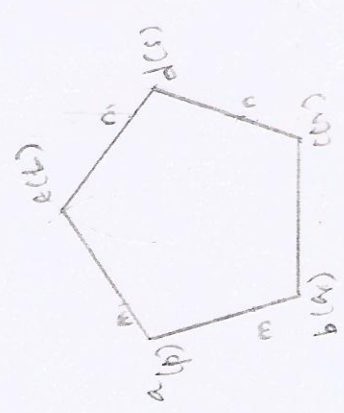
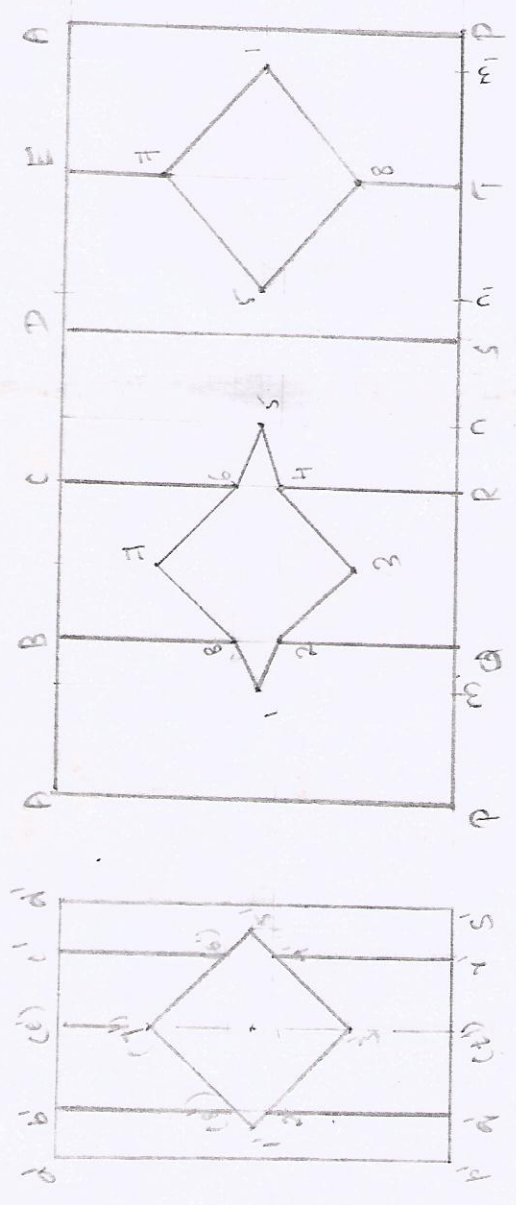

2 set - 18
36

Unit. v

3

Isometric Projection

1. Draw the isometric view of a hexagonal Prism of base side 15mm and height 35mm when it rests on one of its ends on the Hp with two of its base sides parallel to the Vp.

27
36
63

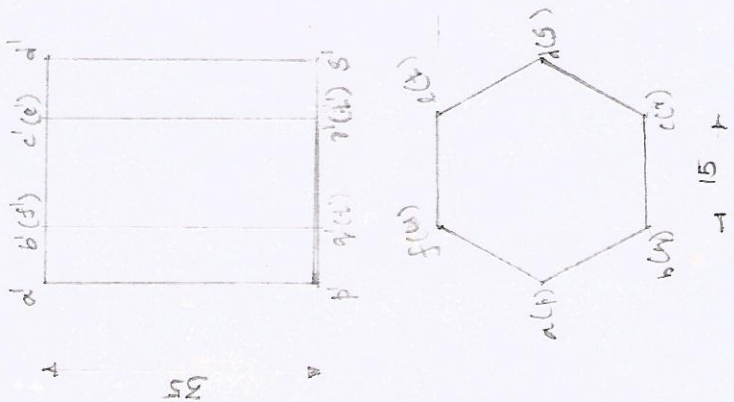
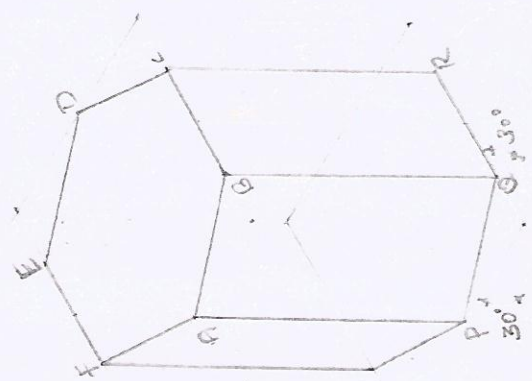

2 Draw the isometric view of a frustum of a hexagonal pyramidal when it is resting on its base on the HP with two sides of the base parallel to the VP. The side of base is 20mm & top 8mm. The height of the frustum is 55mm.

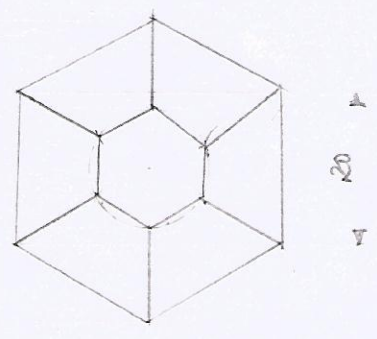
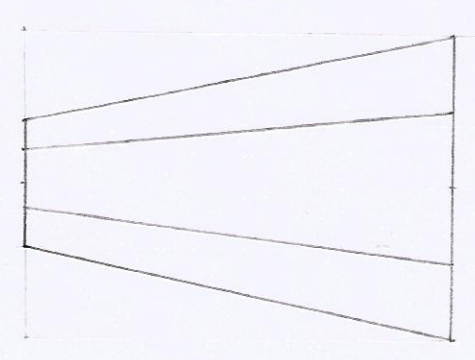
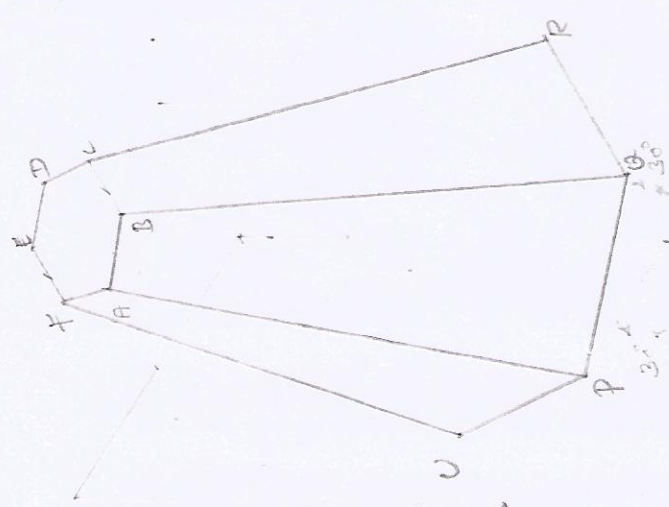

55

3. A hexagonal Prism of base side 20mm & height 45mm has a square hole of side 16mm at the centre. The axes of the square and hexagon coincide, one of the faces of the square hole is parallel to a face of the hexagon. Draw the isometric view of the Prism with hole to full scale.

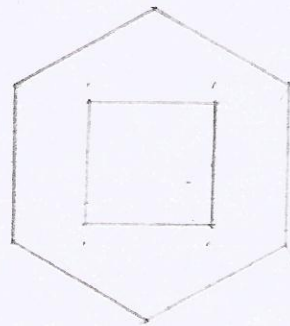
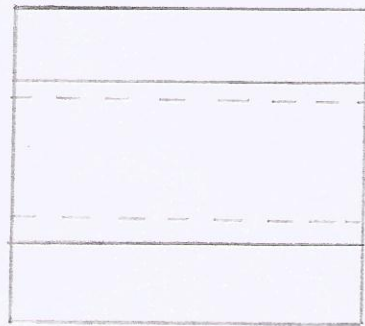
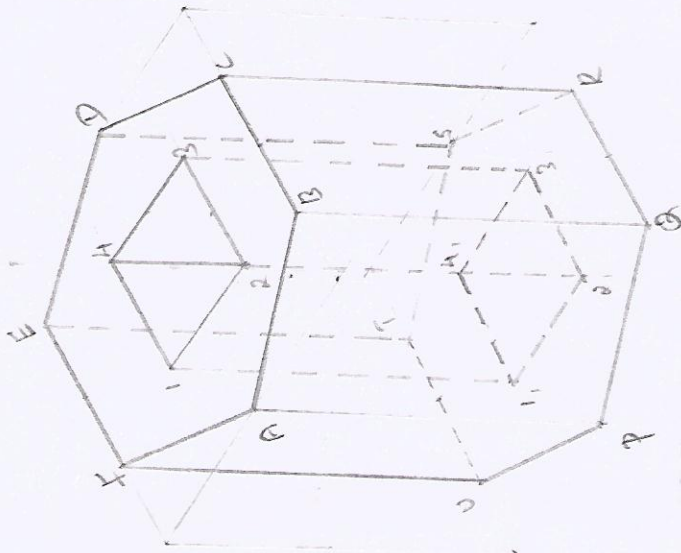

45

VP
HP

X

4. Draw the isometric view of a cylinder resting on one of its ends on the Hp.

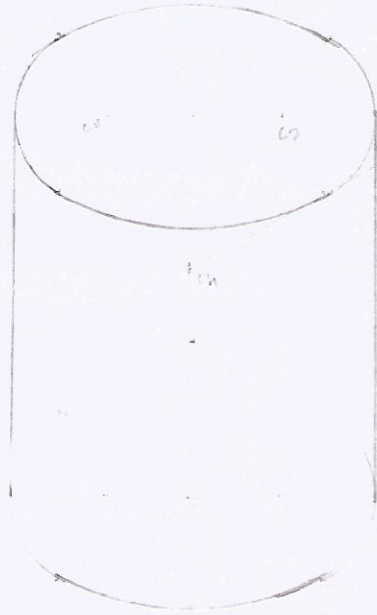
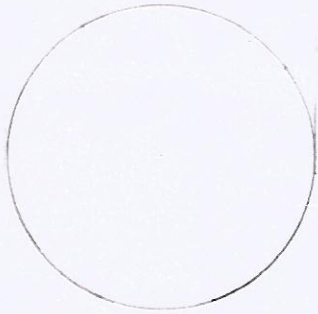

5. A cylinder 50mm diameter & 60mm height stands on Hp. A section plane is to VP, inclined at 55° to Hp cuts the cylinder and passes through a point on the axis at a height of 45mm above the base. Draw the isometric projection of the truncated portion of the cylinder, when the cut surface is clearly visible to the observer.

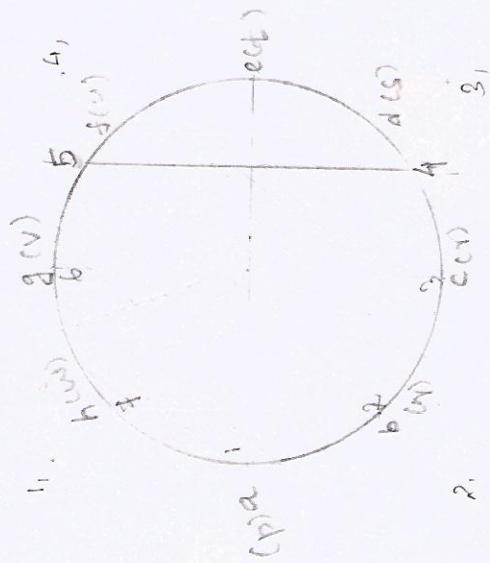
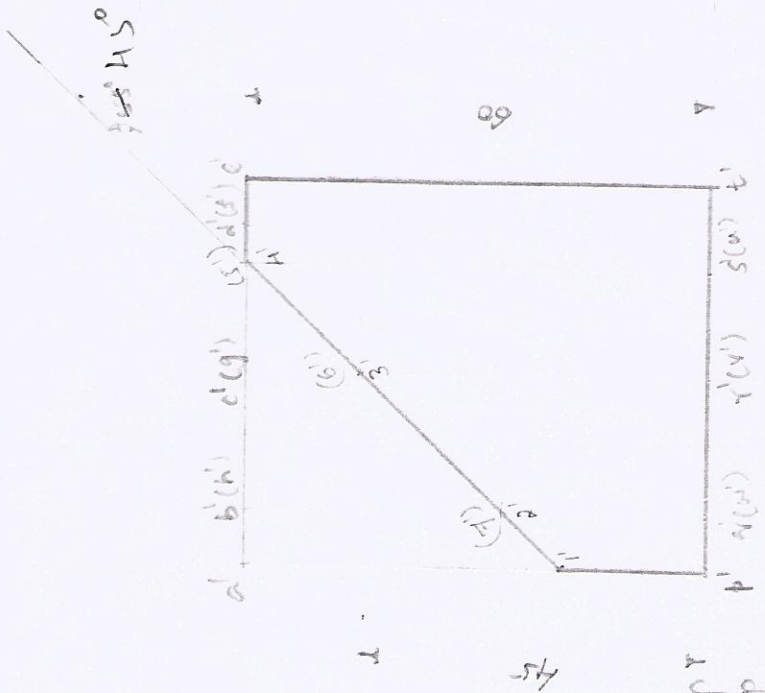
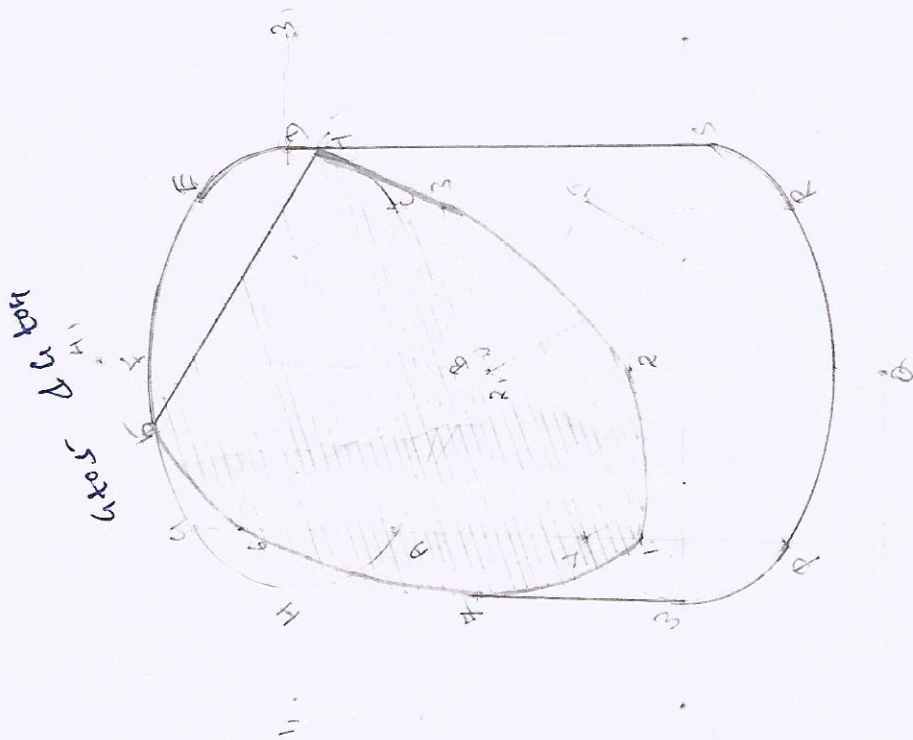

6. A Pentagonal Pyramid, base 30mm & axis 65mm long, rests with its base on H.P. An edge of the base is parallel to V.P. and nearest to it. A horizontal section plane cuts the Pyramid and passes through a point on the axis at a distance of 25mm from the apex. Draw the isometric projection of the frustum of the Pyramid.

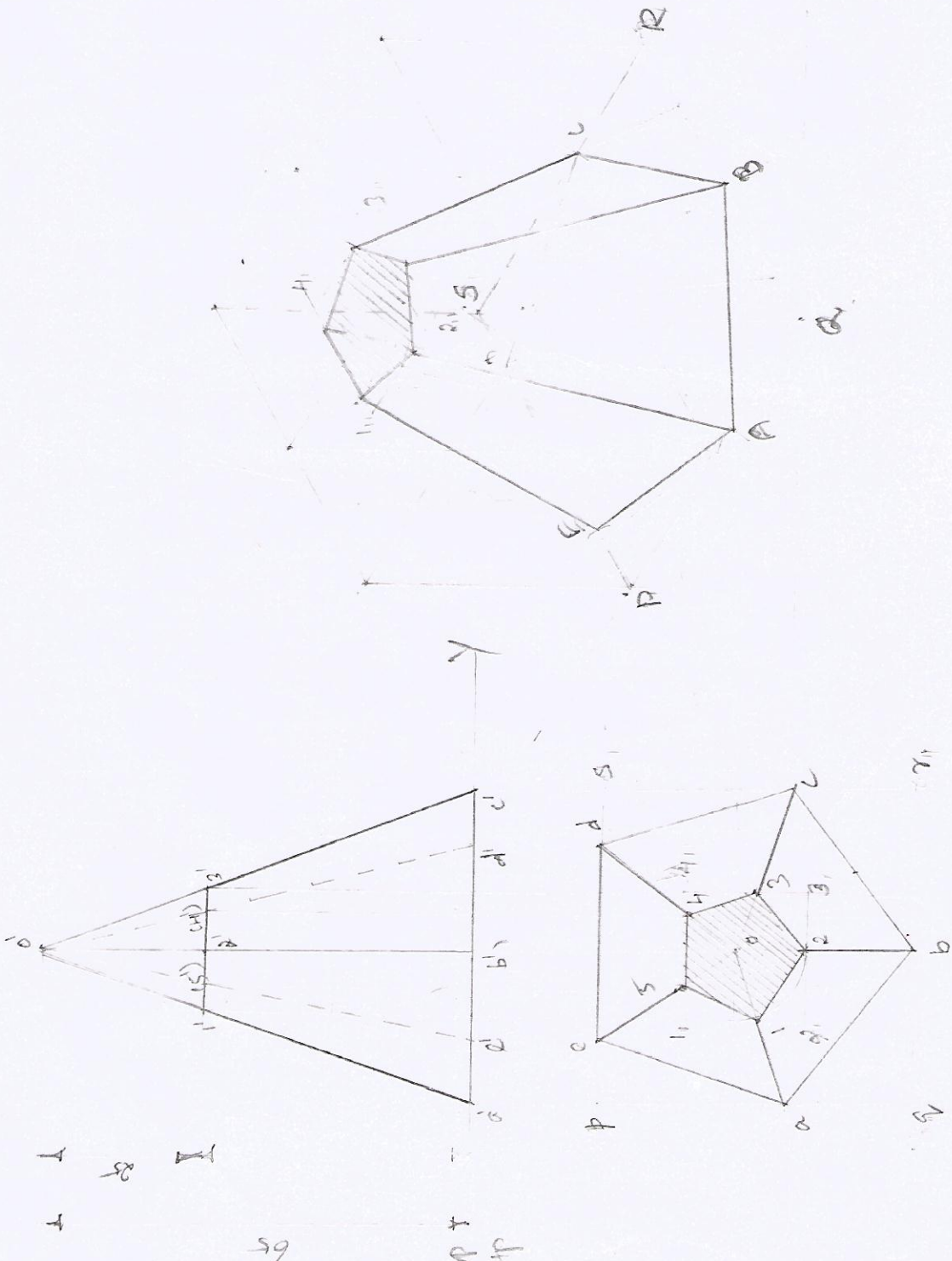

7. A hexagonal Prism, side of base 25mm and height 50mm rests on Hp and one of the edges of its base is Parallel to vp. A ~~section~~ Section Plane \perp to vp and inclined at 50° to Hp bisects the axis of the Prism. Draw the isometric Projection ^{View} of the truncated Prism, showing the cut surface.

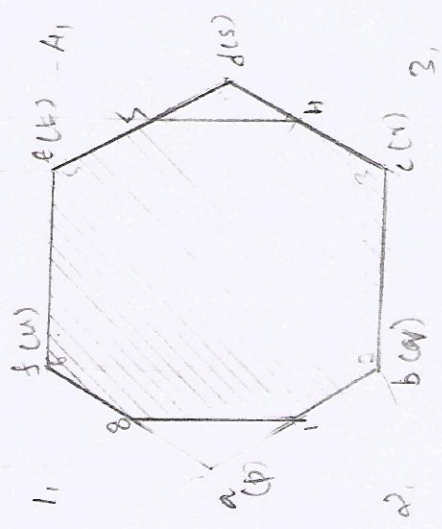
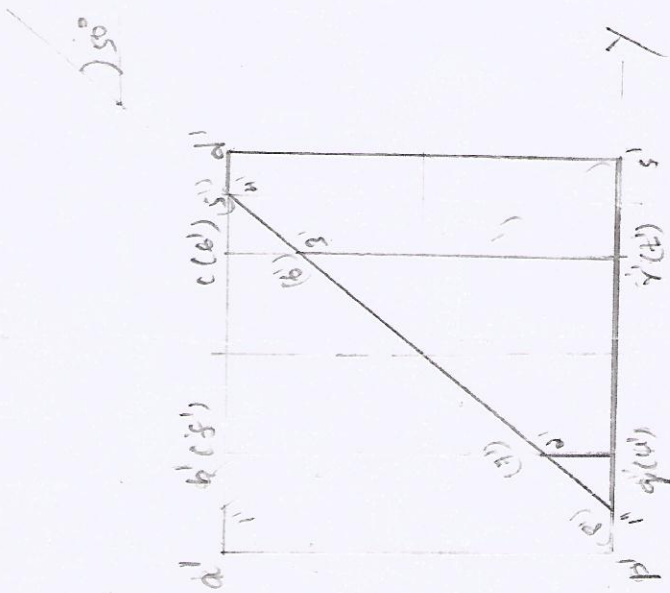
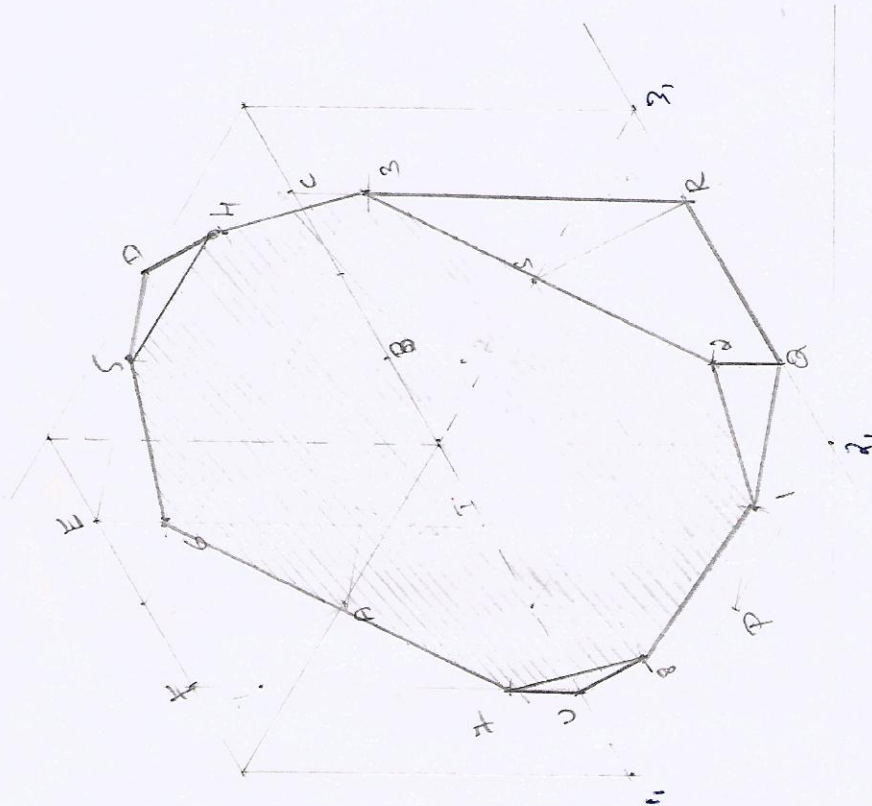

8. A Pentagonal Pyramid, 30mm edge of base and 65mm height, stands on Hp such that an edge of the base is Parallel to V.P. and nearer to it. A section Plane \perp^r to V.P. & inclined at 30° to Hp cuts the Pyramid Passing through a point on the axis at a height of 25mm from the base. Draw the isometric Projection of the Truncated Pyramid. Showing the cut surface.

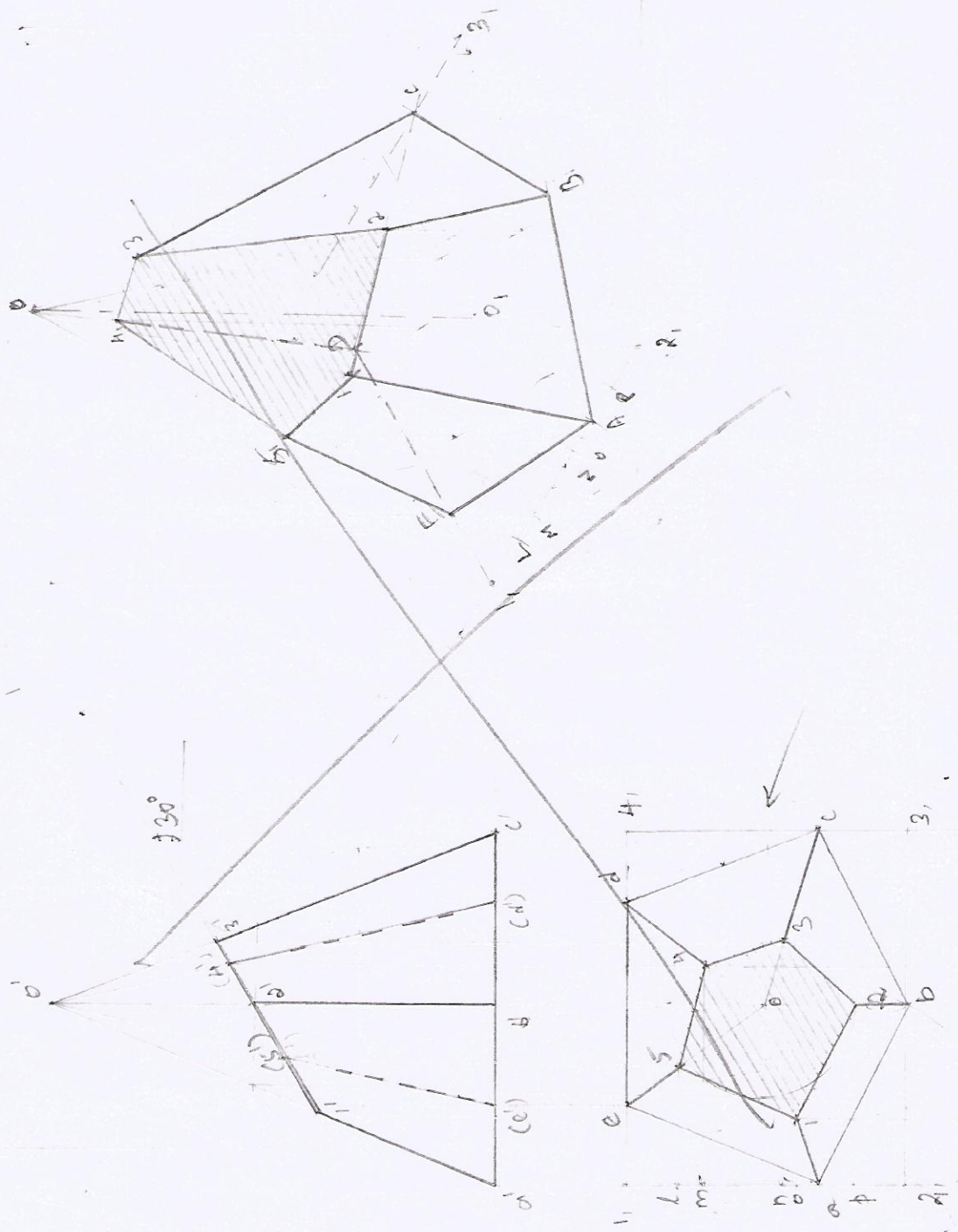

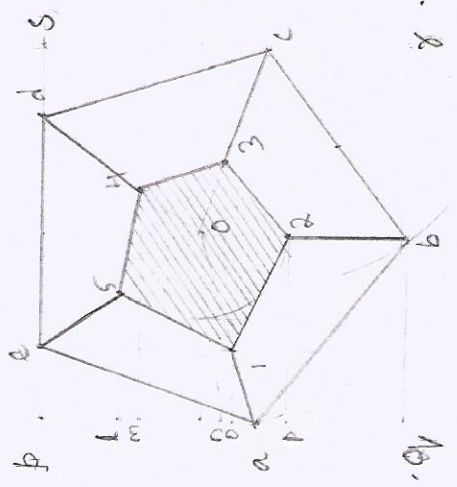
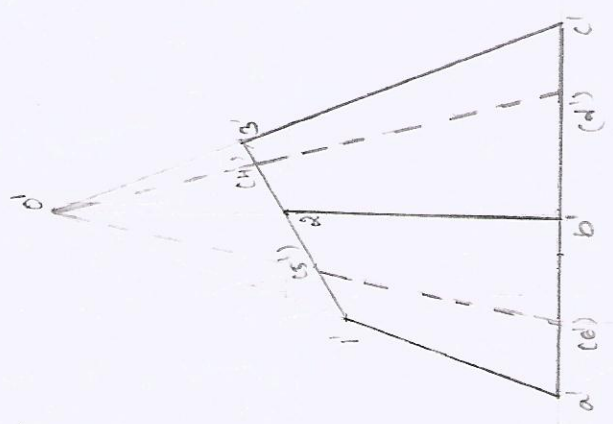
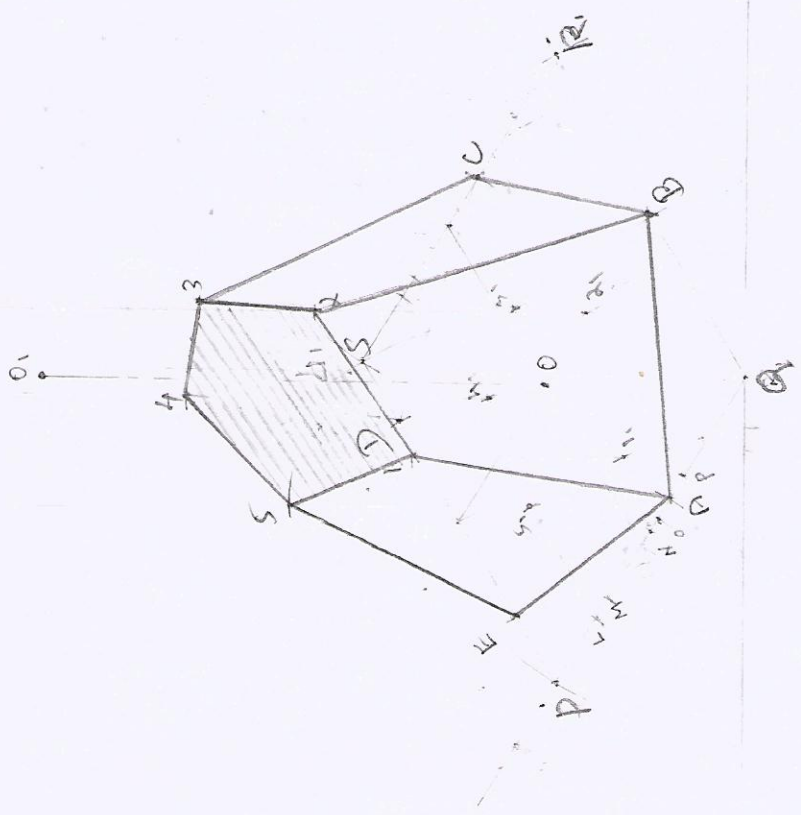

9. A cone of base diameter 50mm and height 55mm is resting on its base on Hp. It is cut by a plane \perp to V.P and inclined at 30° to H.P. The plane meets the axis at a distance of 25mm from apex. Draw the isometric view of the truncated cone.

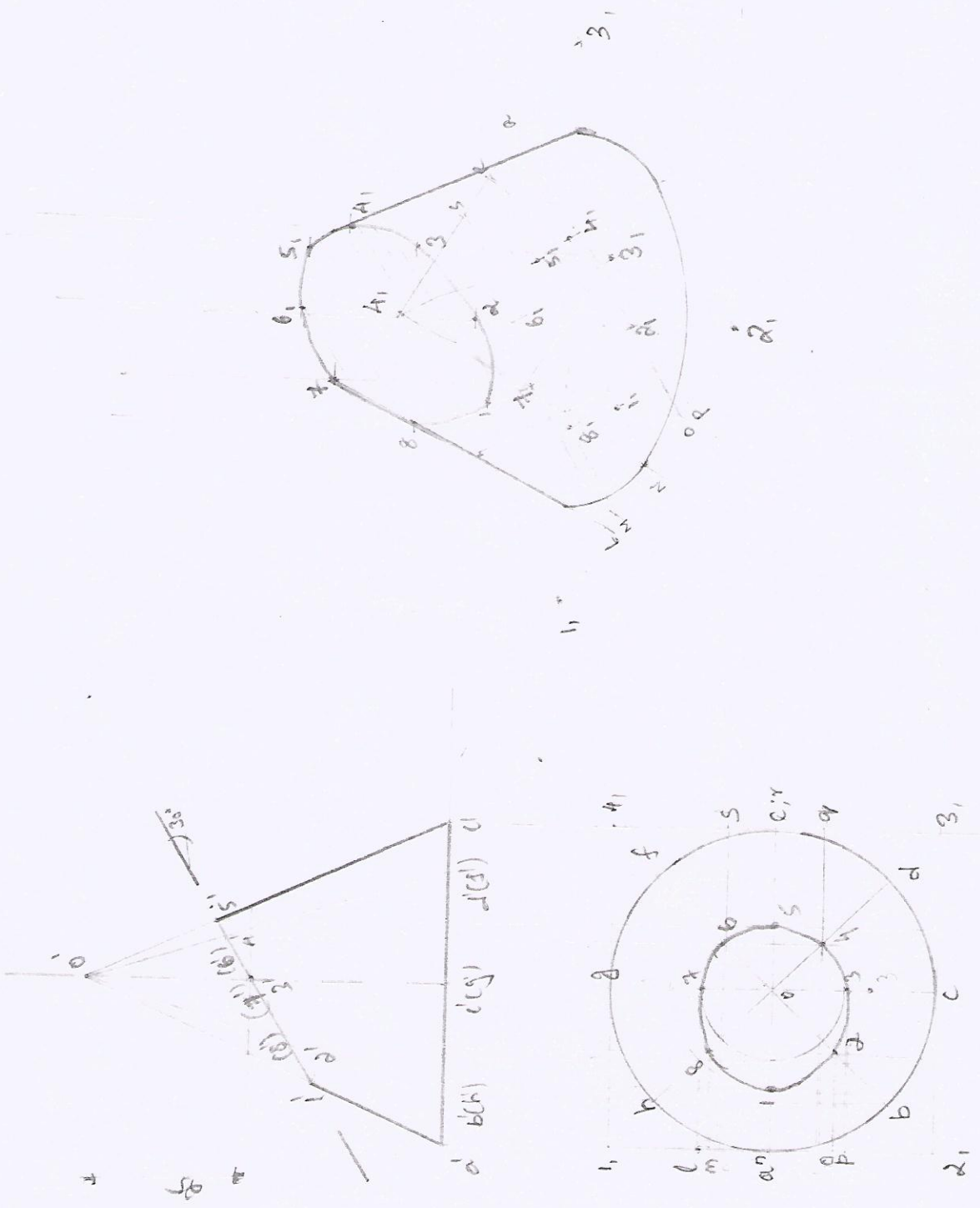

Combination of solids

10. A frustum of a cone has its top & bottom diameters 35mm and 50mm respectively and altitude 53mm. It rests on the top face of a frustum of a square pyramid. Sides of the top & bottom faces of the pyramid are 58mm and 70mm respectively. Height is 22mm. Draw the isometric ^{View} Projection of the combination of solids.

Cone	Square pyramid
Top dia 35mm	Top side 58mm
bottom " 50mm	bottom side 70mm
altitude 53mm	Height 22mm

Cone rest on the top face of the pyramid.

Isometric Projection
 Isometric length = $0.82 \times \text{True length}$

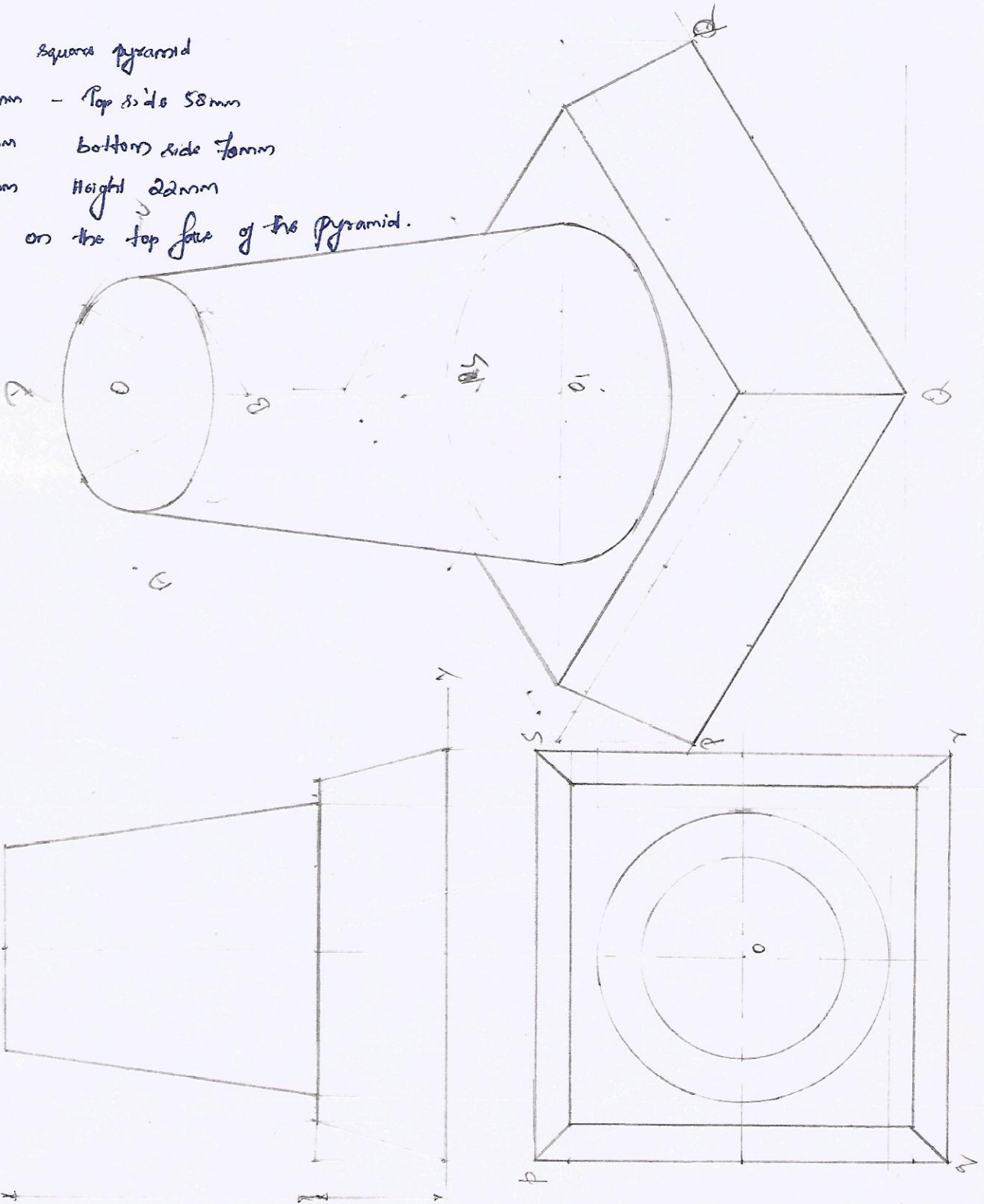

11. Draw the isometric Projection of a funnel consisting of a cylinder and a frustum of a cone. The diameter of the cylinder is 20mm & the top diameter of the funnel is 68mm. The height of the frustum & cylinder are each equal to 40mm.

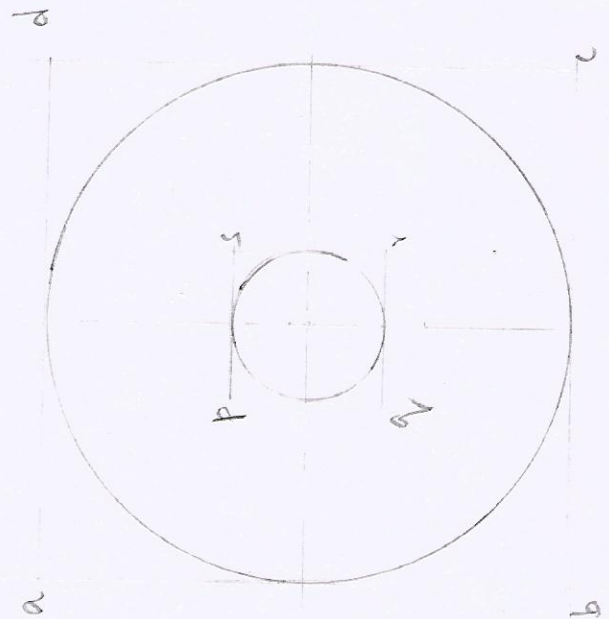
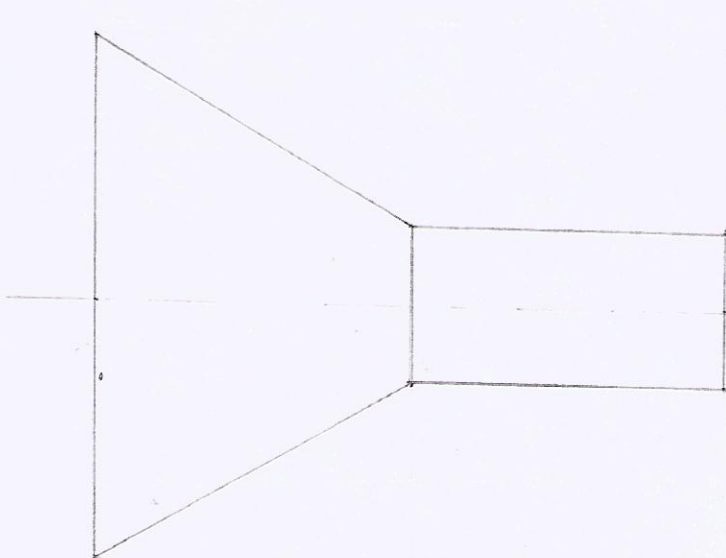
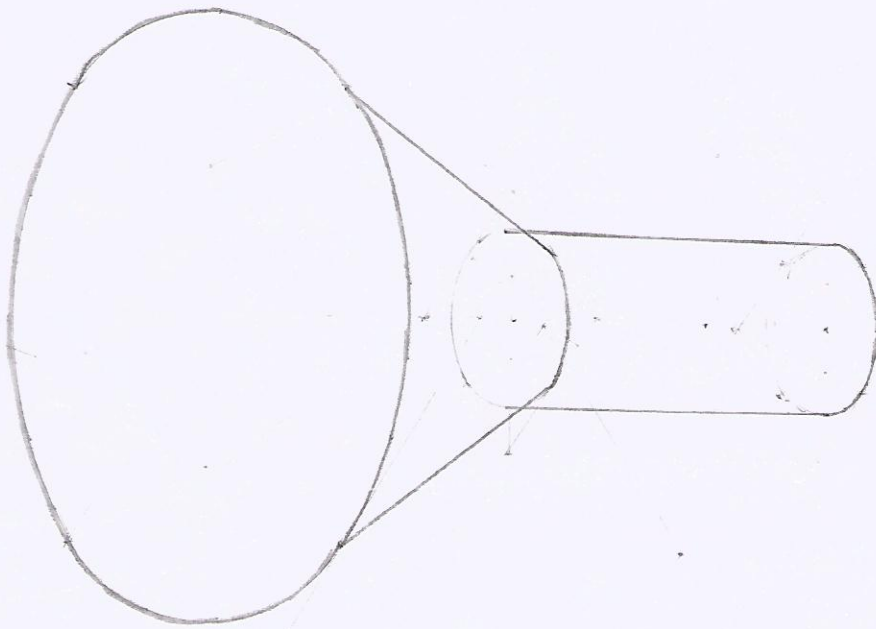

12. Draw the isometric Projection of a sphere of diameter 50mm resting centrally on the top of a cube of side 60mm.

Isometric length
 $= 0.82 \times 60 = 49.2 \text{ mm}$

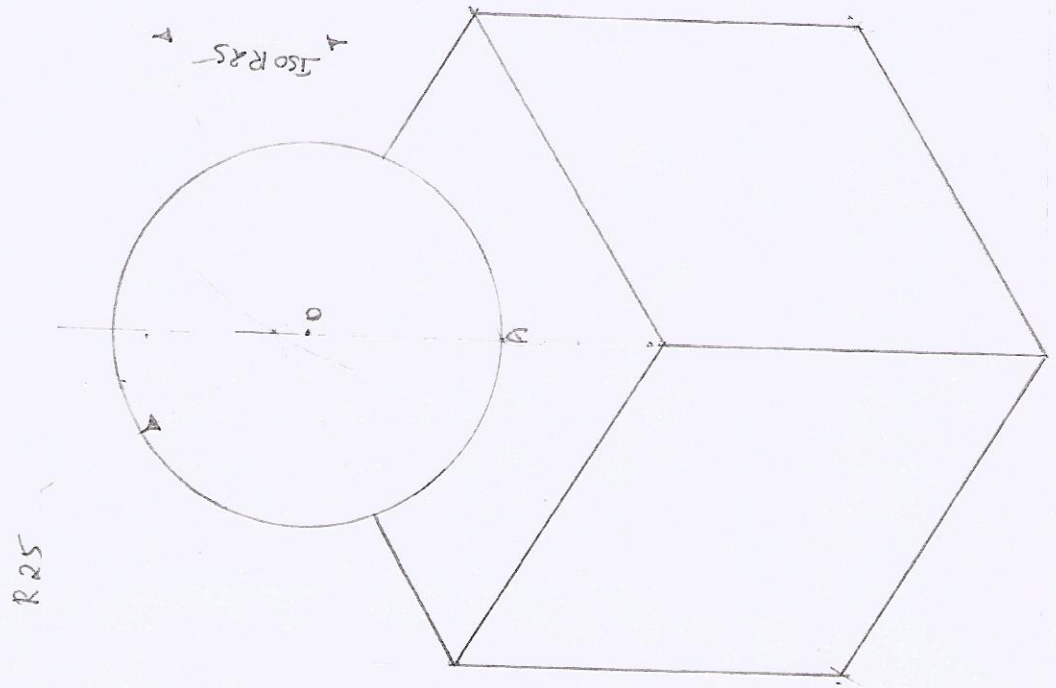
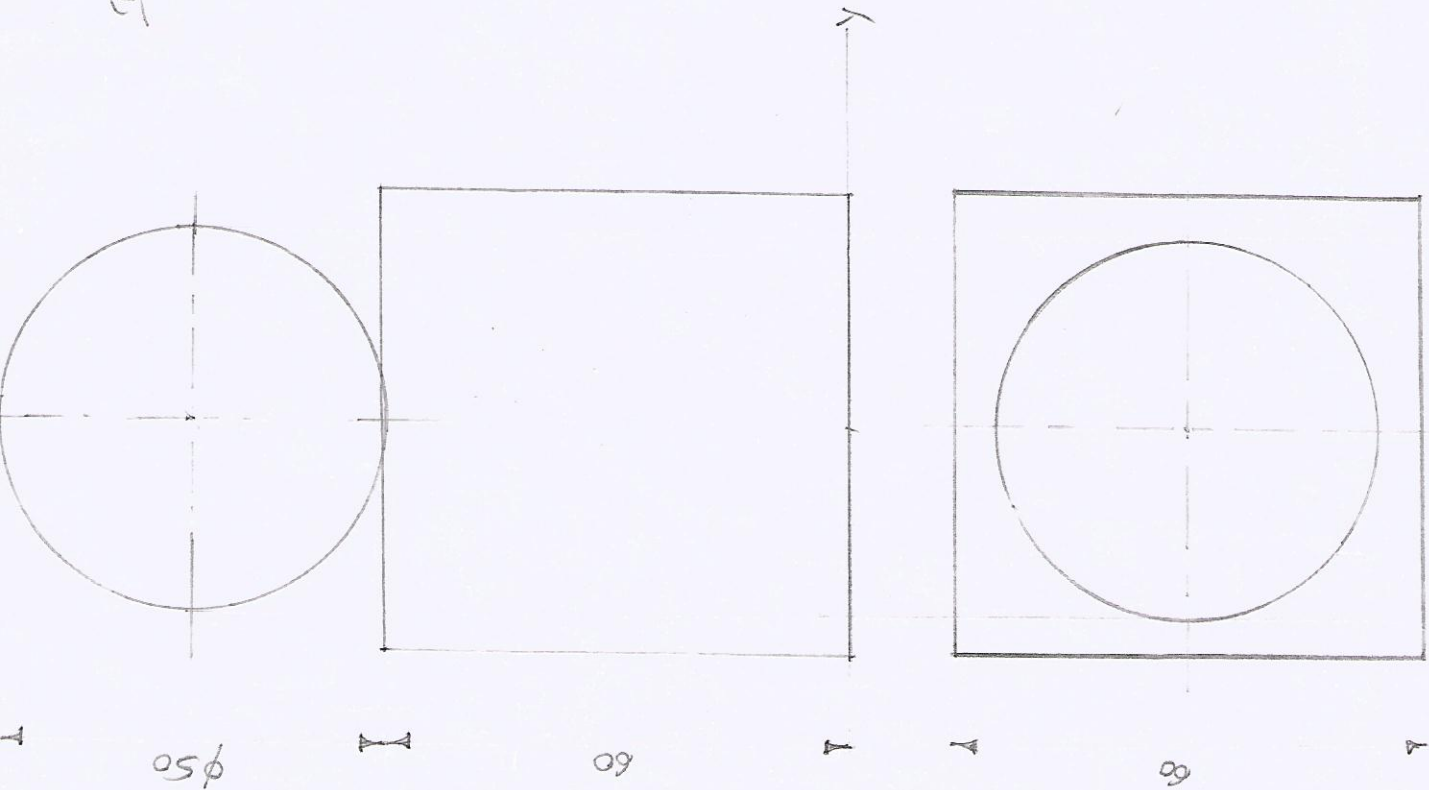

13. A rivet head has the shape of a hemisphere of 60 mm diameter. It is placed centrally over a cylindrical shank of 40 mm diameter and 60 mm length. Draw the isometric projection of the rivet.

Isometric length = 0.82×40
 $= 32.8 \text{ mm}$
 $\therefore = 0.82 \times 60$
 $= 49.2 \text{ mm}$

R30

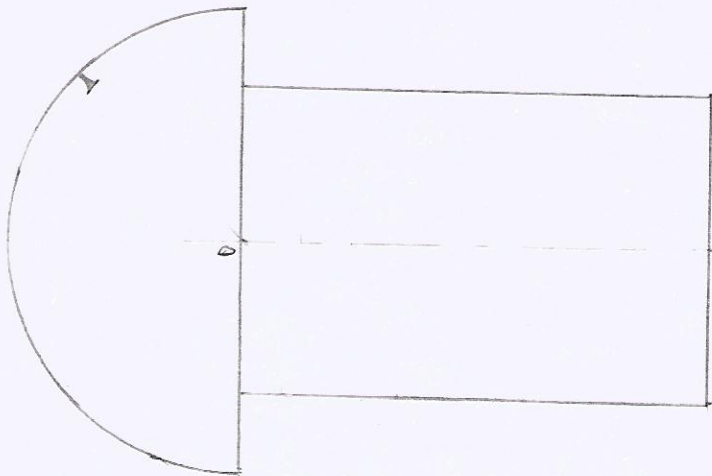

R30

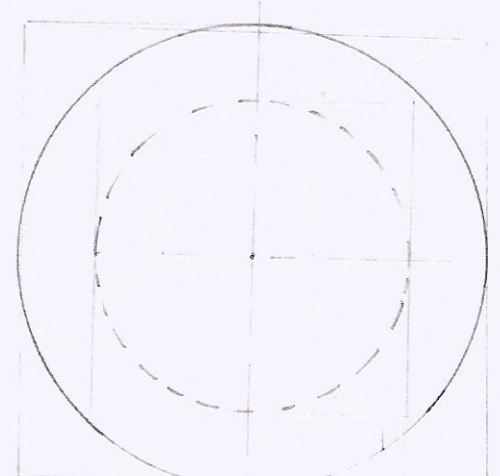
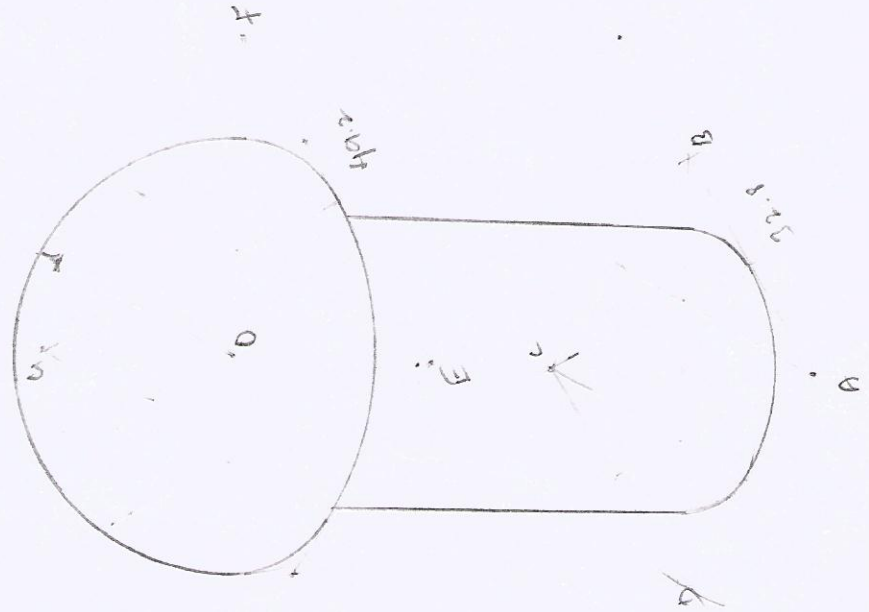

$\phi 40$
 $\phi 60$

14. Draw the isometric Projection of sphere of diameter 16mm kept centrally over a frustum of a square pyramid of height 25mm. The frustum has a base of side 35mm and top of side 20mm.

$$\text{Height} = 0.82 \times 25 = 20.5 \text{ mm}$$

$$R = 0.82 \times 8 = 6.56 \text{ mm}$$

$$\text{Isometric length} = 0.82 \times 35 = 28.7 \text{ mm}$$

$$= 0.82 \times 20 = 16.4 \text{ mm}$$

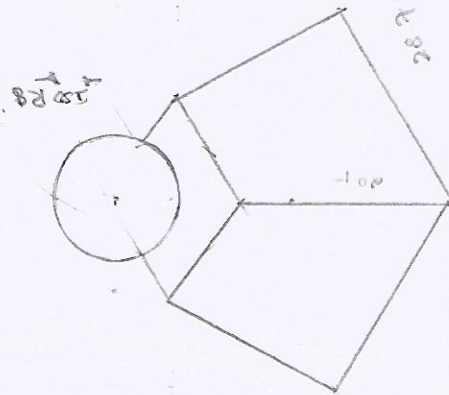
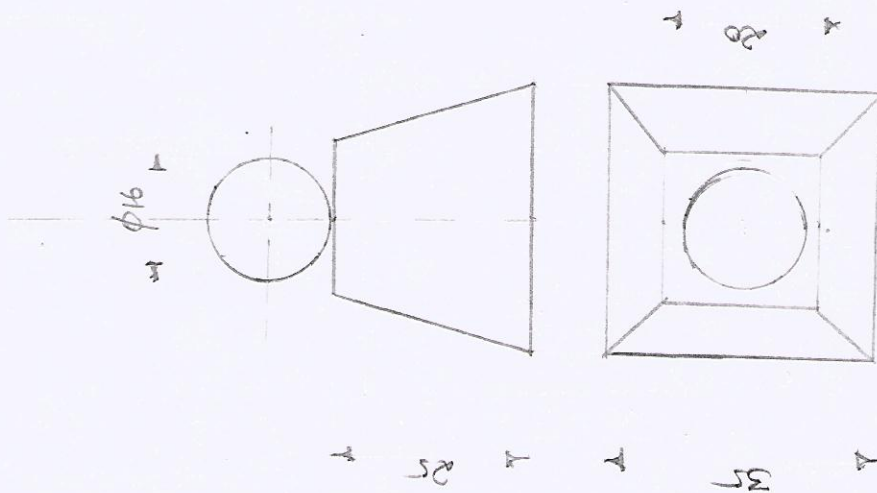

15. A hemispherical vessel of diameter 90mm is placed centrally over a cylinder of diameter 60mm & height 75mm which in turn is kept centrally over a square Prism of base side 80mm & height 20mm. Draw the isometric Projection of the disposition of the solids.

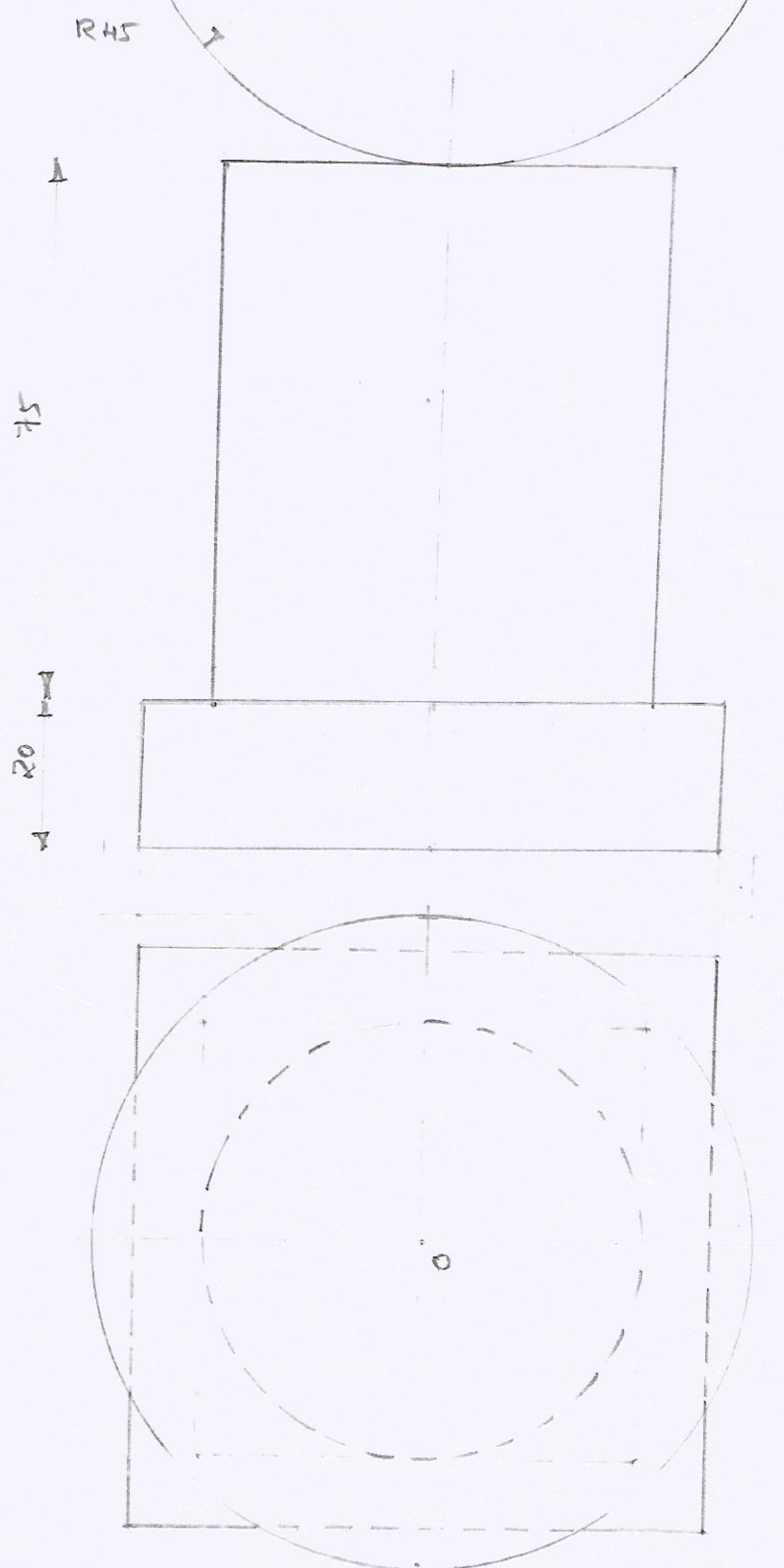

Prism
 $80 = 0.82 \times 80$
 $= 65.6 \text{ mm}$
 $20 = 0.82 \times 20$
 $= 16.4 \text{ mm}$

Cylinder
 $60 = 0.82 \times 60$
 $= 49.2 \text{ mm}$
 $75 = 0.82 \times 75$
 $= 61.5 \text{ mm}$

Y

140 R = 45 x 0.82
= 36.9mm

90 x 0.62 = 55.8

2x2

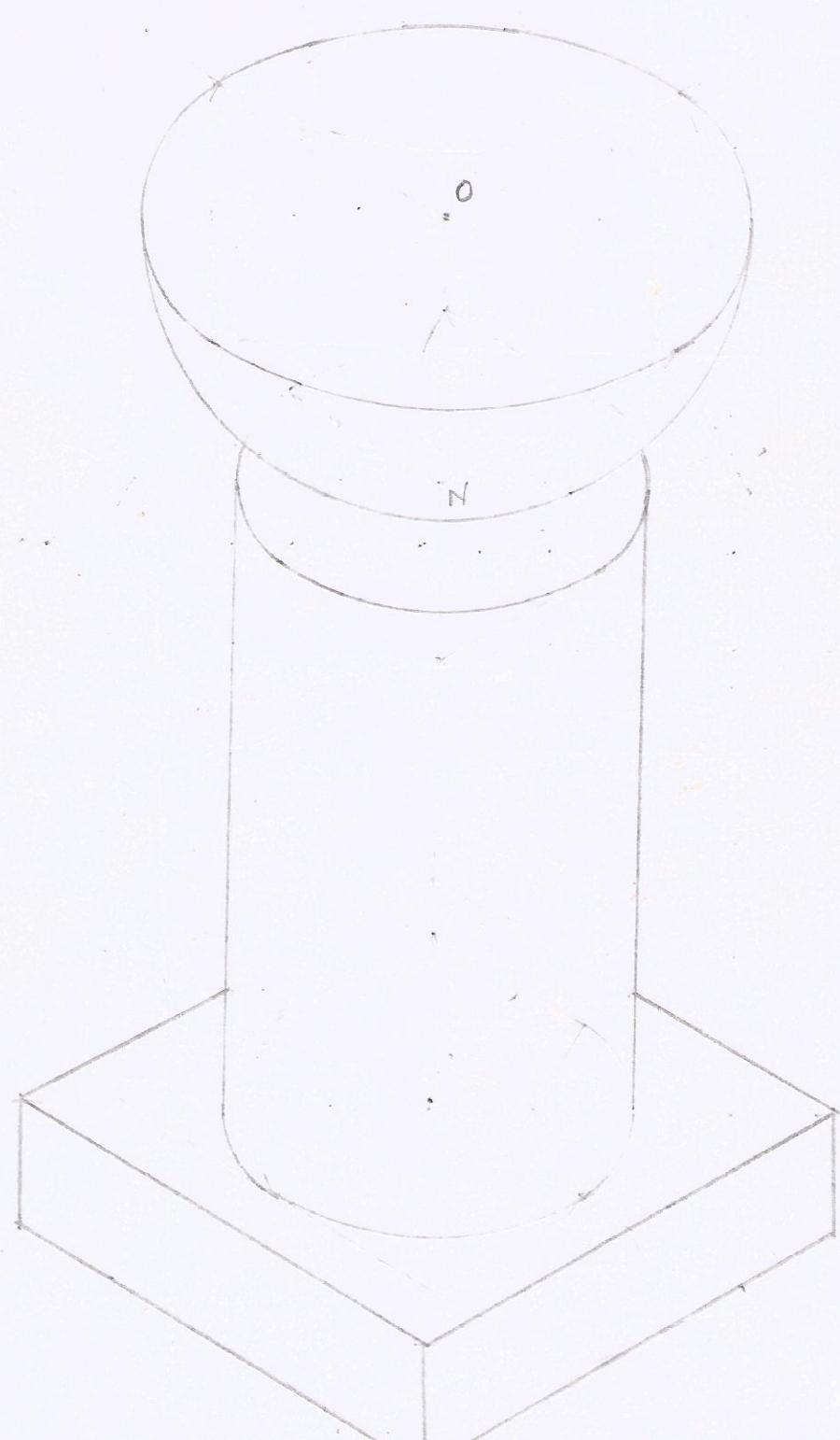

PERSPECTIVE PROJECTION

Visual Ray method

1. A square Prism, side of base 10mm and height 60mm rests with its base on the ground such that one of its rectangular faces is parallel to and 10mm behind the picture plane. The station point is 30mm in front of PP, 80mm above the ground plane and lies in a central plane 45mm to the right of the center of the Prism.

top view

PP to GL
 $30 + 80 = 110$
 more than 110mm

- CP → Central plane
- PP → Picture plane
- HL → Horizon plane
- GL → Ground plane

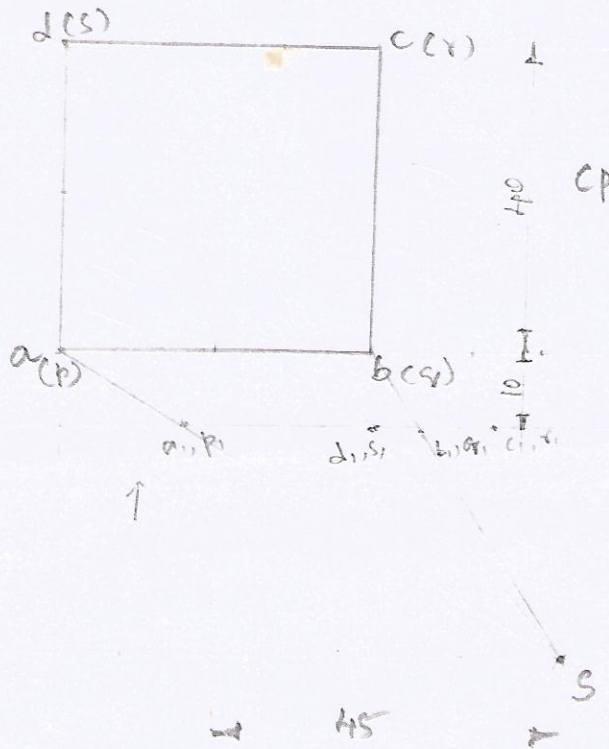

- PP
- GL
- HL

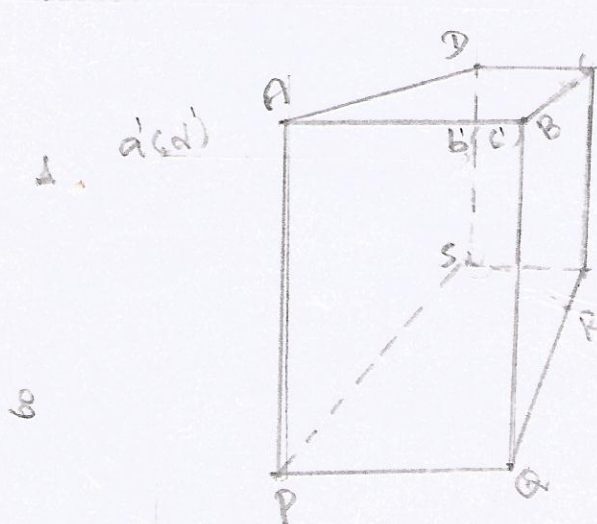

- GL

2. A rectangular Prism, sides of base 50mm x 30mm and height 55mm, rests with its base on the ground plane. A vertical edge is in the Picture plane and one of the longer edges of its base is inclined at 45° to PP and behind it. The Station Point is 50mm in front of PP, 75mm above the ground plane and lies in a central plane which passes through the center of the Prism. Draw the Perspective Projection of the solid.

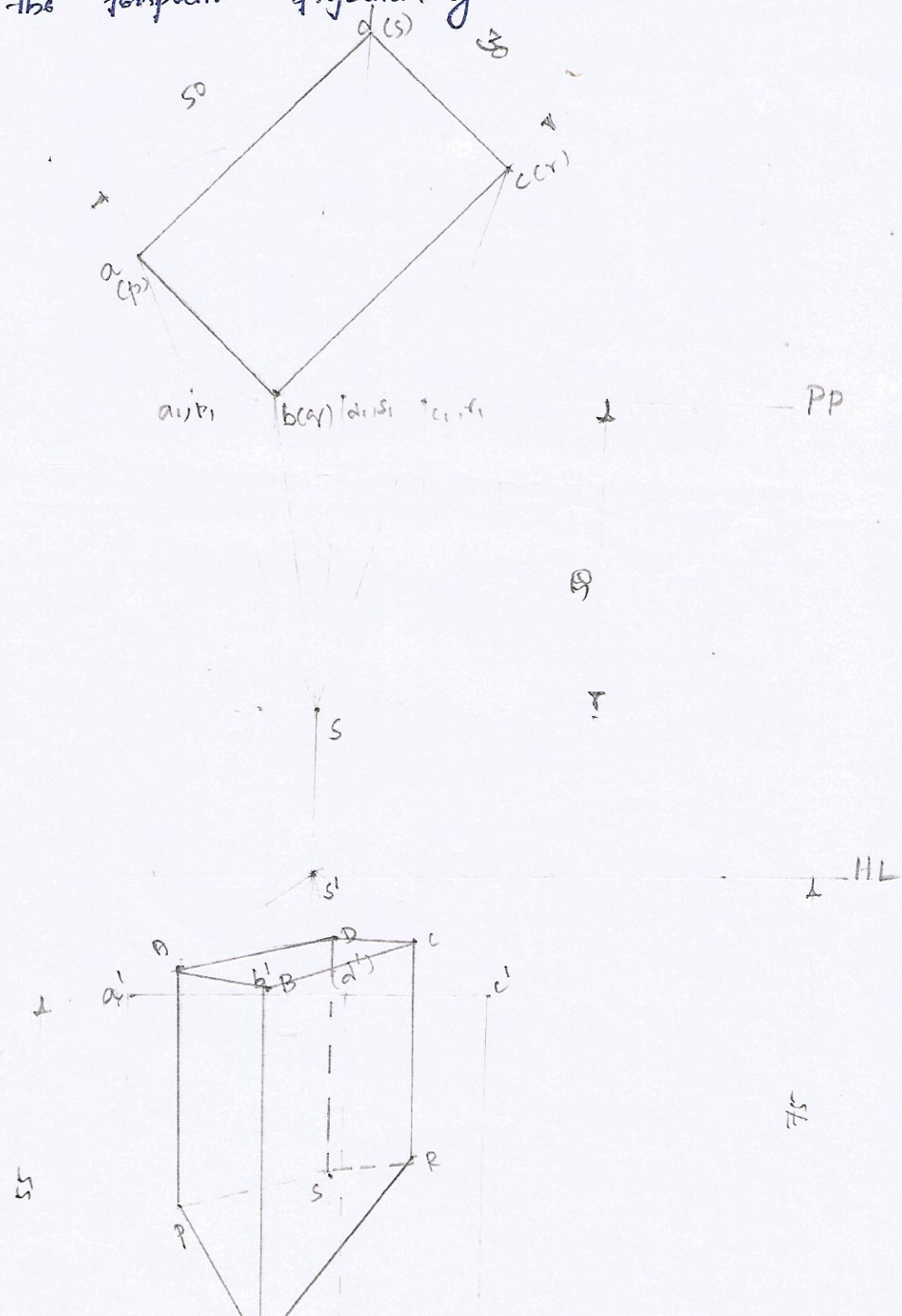

3. A Square Pyramid of base side 30mm & altitude 40mm rests on its base on the ground such that one of its base sides is Parallel to the Picture Plane and 10mm in front of it. The station point is 50mm in front of the picture plane, 25mm to the left of the axis of the Pyramid and 55mm above the ground. Draw the Perspective view of the Pyramid.

$50 \times 15 = 105$
 $\rightarrow 105$
 — PP
 — GL

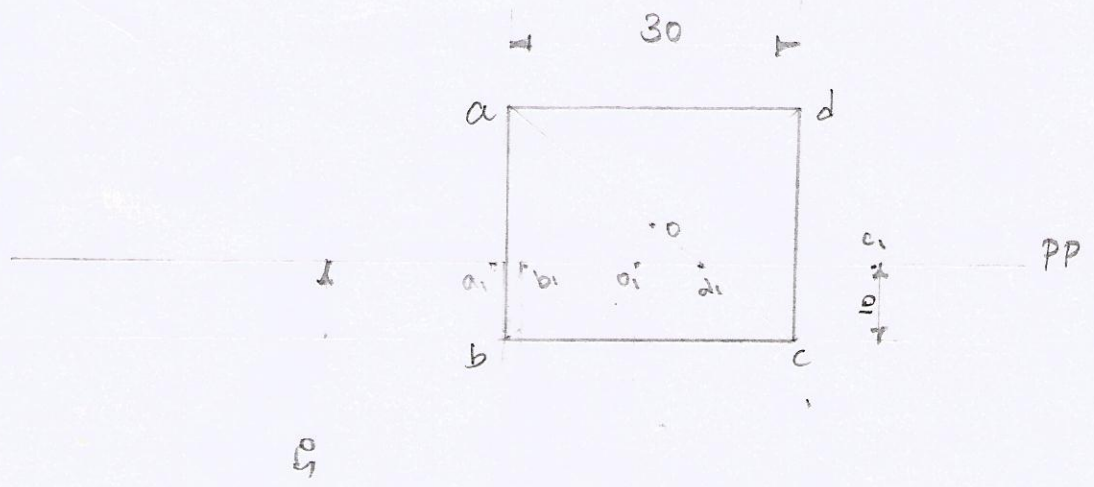

5

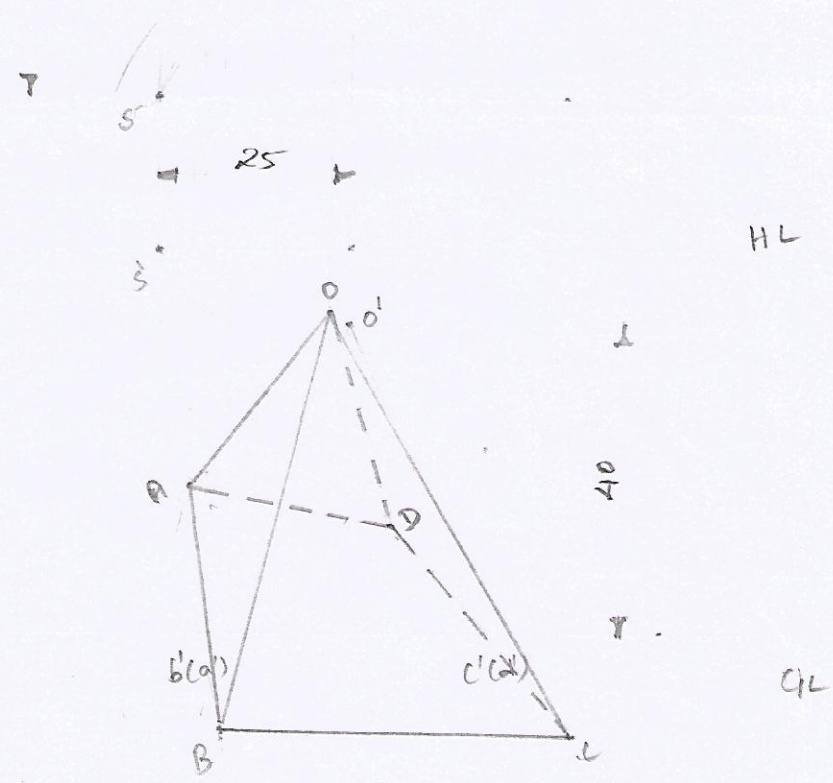

Ex. A Square Pyramid of base edge 30mm & altitude 55mm , rests with its base on the ground plane such that all the edges of the base are equally inclined to the PP. One of the corners of the base is touching the PP. The station point is 60mm in front of the PP, 60mm above the ground plane and lies in a central plane which passes through the axis of the pyramid. Draw the Perspective Projection.

$80 + 60 = 140$
 > 140

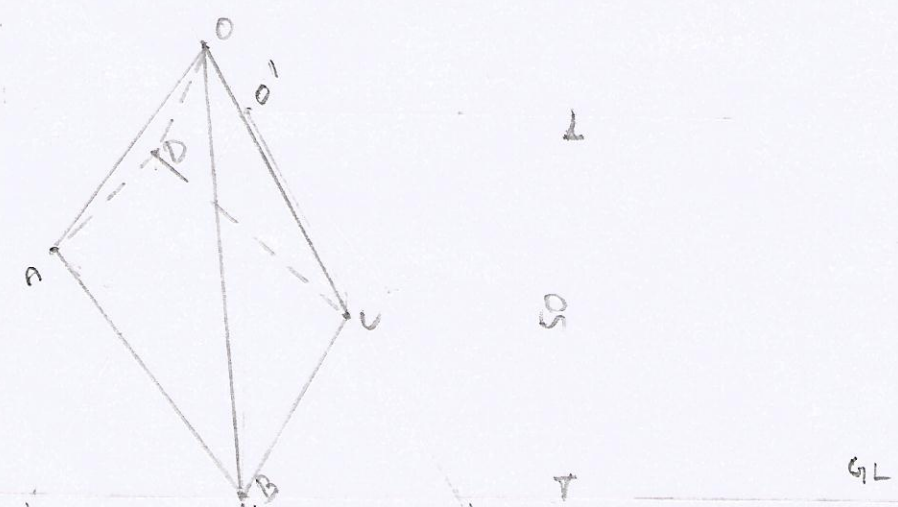
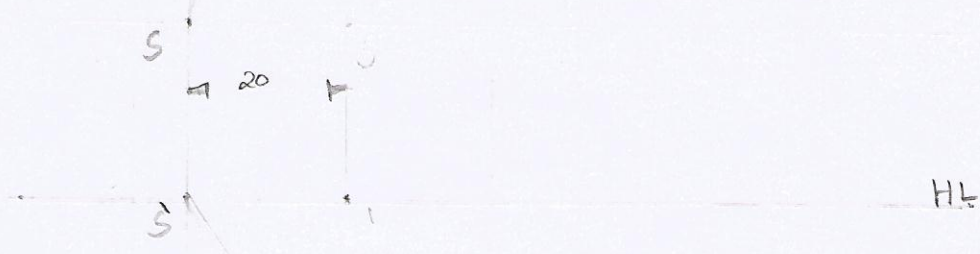
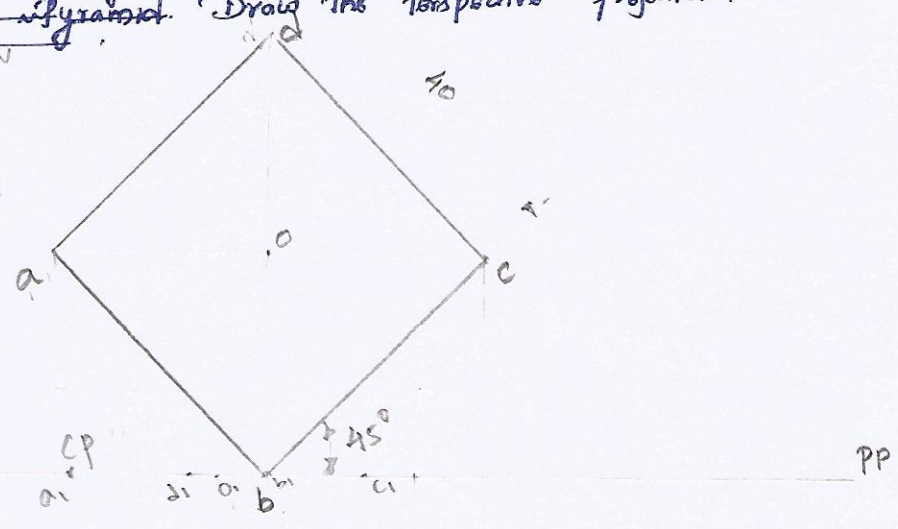

5. A regular hexagonal Pyramid of base edge 20mm and height 35mm rests on its base on the ground plane with one of its base edges touching the Picture plane. The station point is 30mm above the ground plane and 40mm in front of the PP. The Central plane is 30mm to the right of the axis. Draw the Perspective Projection of the Pyramid.

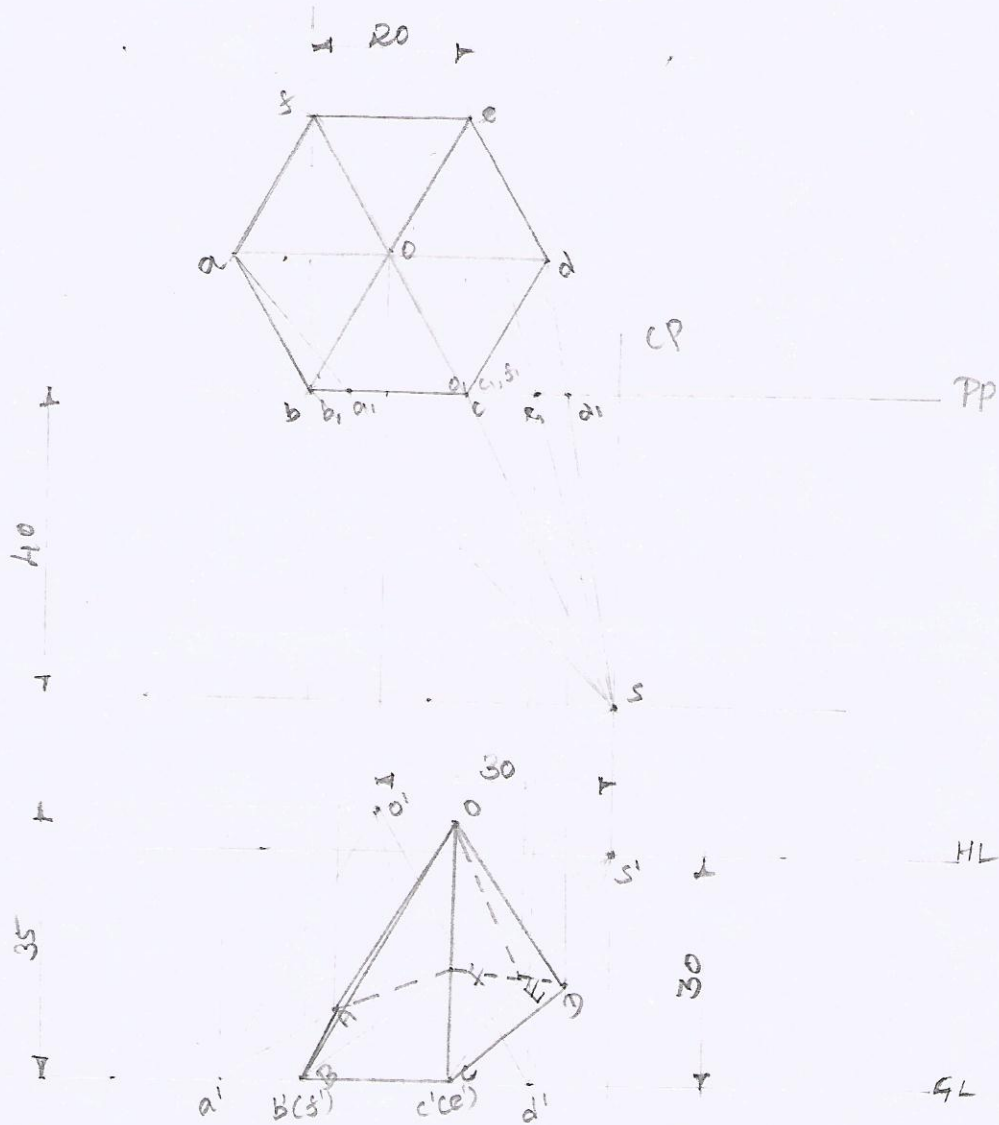

6. A cylinder of diameter 40mm & height 60mm rests on the GP on one of its ends with its axis 35mm behind the Picture plane. The station point is 45mm to the right of the axis. (The station point is 65mm above the GP and 40mm in front of the PP. Draw the Perspective view of the cylinder by Visual ray method.

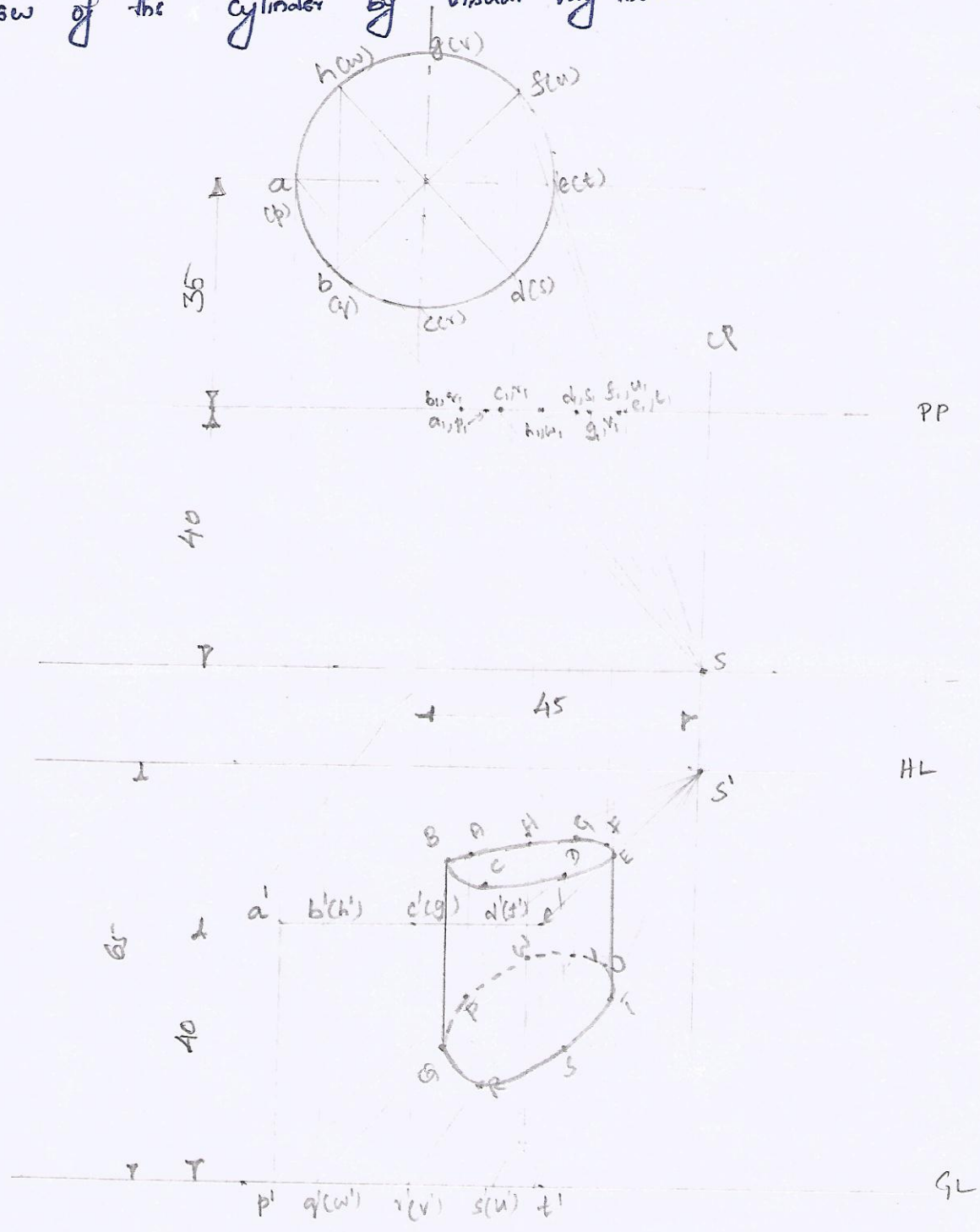

4. A square Prism of base 25×25 mm & height 40mm rests on the GP with the edges of the base making 45° with PP. The corner nearest to the PP is 25mm to the right of the station point and 25mm behind the PP. The station point is 55mm above the GP & 70mm in front of the PP. Draw the Perspective view of the square Prism.

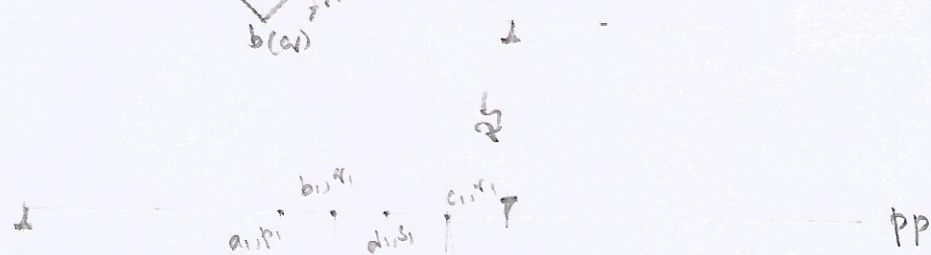
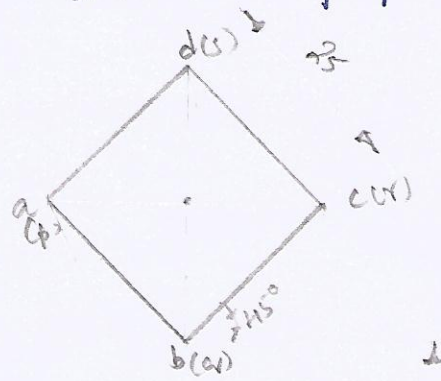

5 in left side

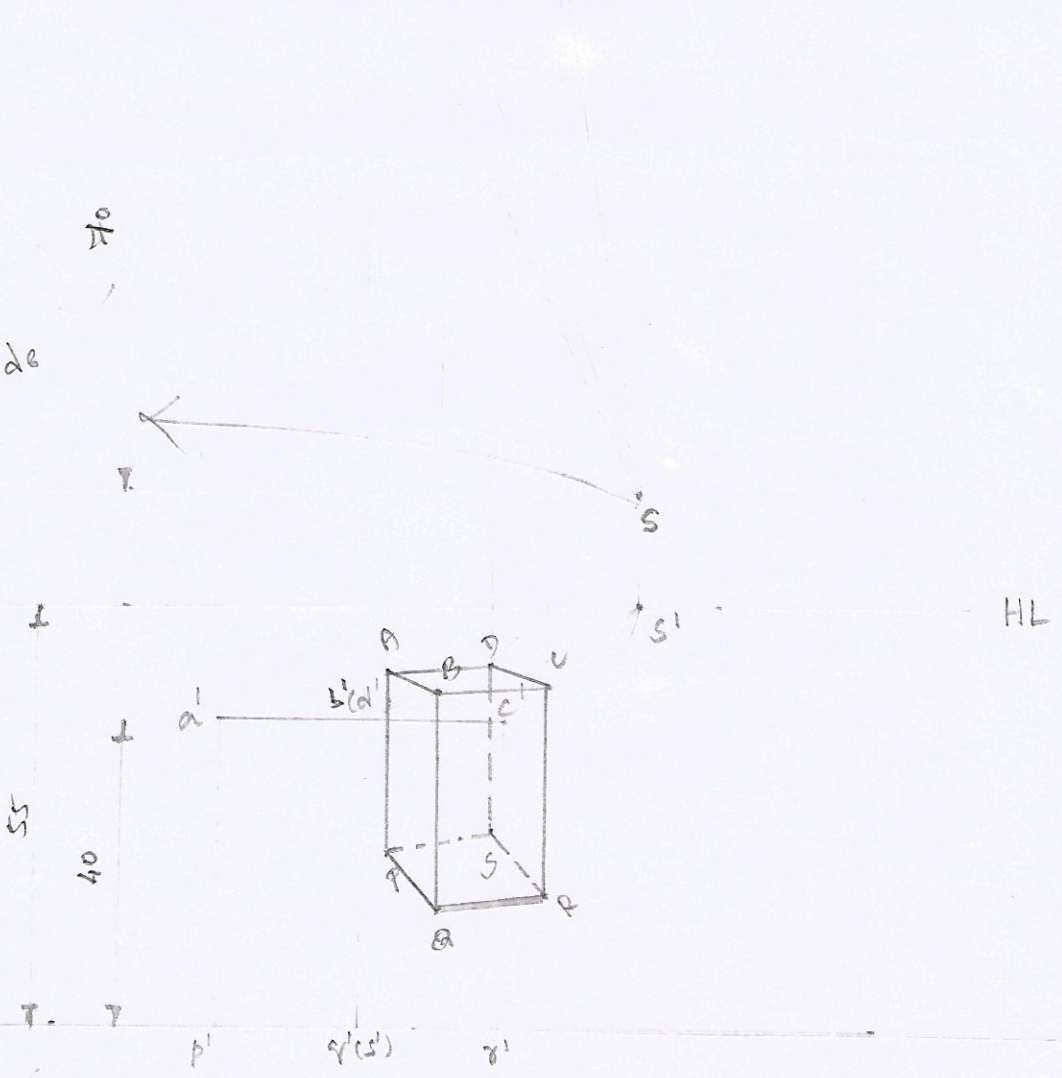

8. Draw the Perspective view of a Pentagonal Prism of base side 20mm and height 40mm when it rests on its base on the ground plane with one of its rectangular faces parallel to and 20mm behind the picture plane. The station point is 45mm in front of the PP and 60mm above the CP. The observer is 20mm to the left of the axis. ~~Use the top view and~~

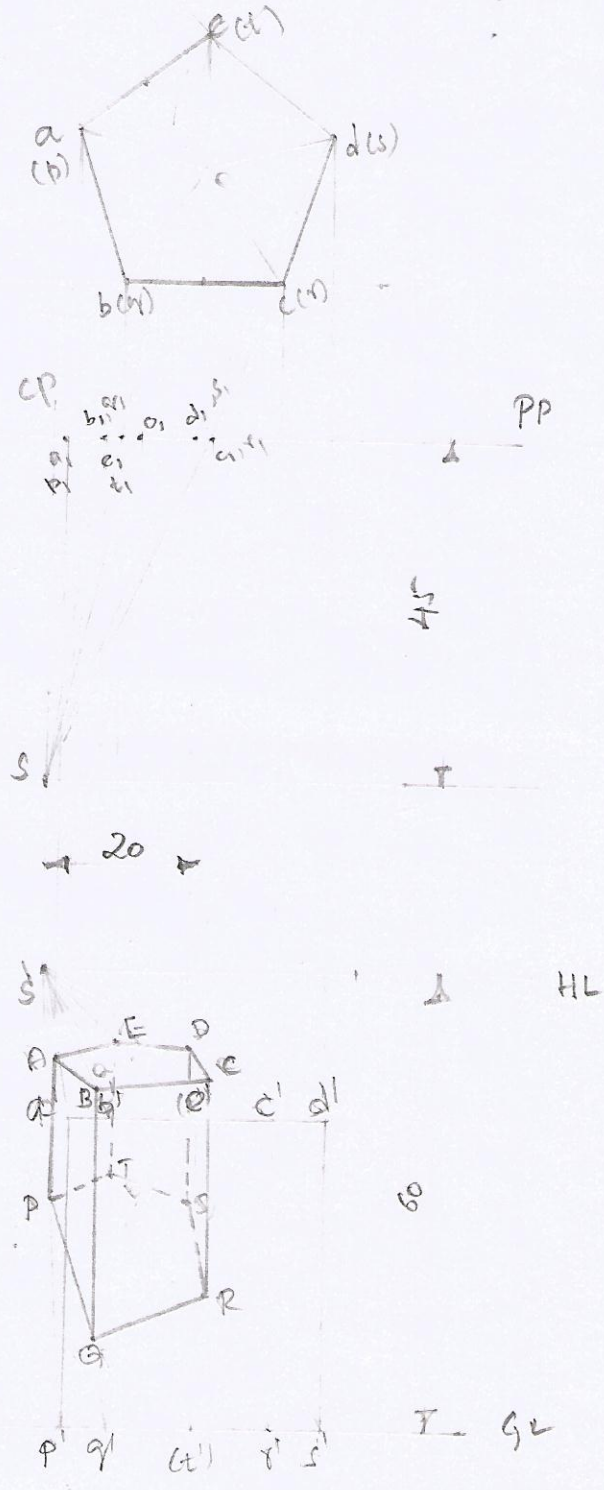

Top - ABCD
 Bottom - PQRS
 40

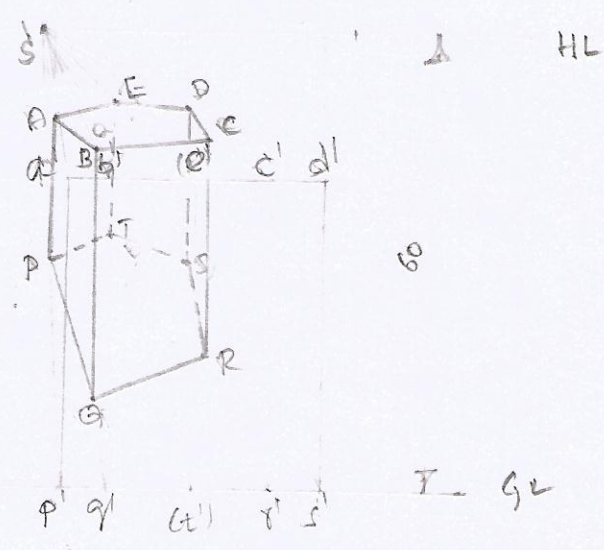

9. A cone of base diameter 40mm & height 40mm rests on the GP on one of its ends with its axis 35mm behind the picture plane. The station point is 45mm to the right of the axis. The station point is 65mm above the GP and 40mm in front of the PP. Draw the Perspective view of the cone.

✓ 28/12/13

